

Mar. 2011



SERVICE MANUAL ADDENDUM

UR-FR5000 UR-FR5100

CONTENTS

PARTS LIST	1
BOARD LAYOUTS	8
VOLTAGE DIAGRAM	10

PARTS LIST

[MAIN UNIT]

REF NO.	PARTS NO.	DESCRIPTION	M.	H/V LOCATION
IC1	1110005330	S.IC NJM12904V-TE1-#ZZZB	T	58.1/71.4
IC2	1110007290	S.IC AK2330P-L	T	58.7/56.2
IC3	1130010100	S.IC LMX2352TMX/NOPB	B	120.2/43.9
IC4	1130010100	S.IC LMX2352TMX/NOPB	B	28.1/78.9
IC5	1110003491	S.IC TA31136FNG(DEL)	B	70.5/82.5
IC7	1110007280	S.IC NJM2716F-TE1-#ZZZB	B	56.8/46.4
IC8	1130012910	S.IC AK4554VTP-E2/P	B	36.2/59.9
IC9	1190002080	S.IC AD7476ARTZ-500RL7 <FE>	B	49.6/46.4
IC10	1130013040	S.IC TC7WBD125AFK(T5LF)	B	46.6/49.2
IC11	1110006230	S.IC NJM2711F-TE1-#ZZZB	B	53.1/35.0
IC12	1140013290	S.IC TMS320VC5509AZHH	B	33.4/37.9
IC13	1180002590	S.REG XC6204B332MR	T	81.0/21.4
IC14	1180003270	S.REG R1114Q161D-TR-F	T	84.4/21.4
IC15	1180002590	S.REG XC6204B332MR	T	87.9/21.4
IC17	1190001340	S.IC M62334FP 600C	T	67.3/61.7
IC18	1110005771	S.IC S-80942CNMC-G9CT2G	T	41.2/52.8
IC19	1180003210	S.REG NJM2831F10-TE1-#ZZZB	B	111.0/26.2
IC20	1140014550	S.IC HD64F2506RFC26DV(EMPTY)	T	33.5/37.7
IC21	1140012950	S.IC 24LC512T-I/SM <SEI>	T	59.2/21.8
IC22	1150002042	IC RA30H1317M-121		
IC23	1110002751	S.IC TA75S01F(TE85RF)	T	141.7/125.1
IC25	1130008561	S.IC TC75S51F(TE85LF)	B	29.0/16.3
IC26	1120003070	S.IC MAX3232EIPWR	T	42.8/70.0
IC27	1180001252	S.IC TA7808F(TE16L1NQ)	T	114.4/85.0
IC28	1110003091	IC LA4425A-E		
IC29	1110002751	S.IC TA75S01F(TE85RF)	T	12.0/123.1
IC30	1110003390	S.IC AN8005M-(E1)	T	98.3/91.4
IC31	1130011760	S.IC CD4094BPWR	T	8.2/45.2
IC32	1130015410	S.IC AT25DF041A-SSH-T	B	8.9/36.1
IC34	1110005340	S.IC NJM12902V-TE1-#ZZZB	B	12.3/58.2
IC35	1140013200	S.IC CD4053BPWR	B	20.6/58.3
IC36	1110005330	S.IC NJM12904V-TE1-#ZZZB	B	27.8/55.4
IC37	1120002830	S.IC NJM2125F-TE1-#FZZB	T	56.7/66.7
IC38	1110006380	S.IC LM2904PWR	T	114.1/23.8
IC39	1180001072	S.IC TA7805F(TE16L1NQ)	T	101.2/24.3
IC40	1110005330	S.IC NJM12904V-TE1-#ZZZB	B	50.6/57.2
IC41	1180001252	S.IC TA7808F(TE16L1NQ)	B	132.0/16.7
Q1	1590003231	S.TRA UNR9113G0L	B	53.4/79.7
Q2	1530002851	S.TRA 2SC4116-BL(TE85RF)	B	35.0/77.7
Q3	1560001360	S.FET 2SK3019 TL	B	66.4/76.3
Q5	1560000541	S.FET 2SK880-Y(T5TRICOMF)	B	35.7/107.1
Q7	1530002601	S.TRA 2SC4215-O(TE85RF)	B	73.0/92.9
Q8	1560000541	S.FET 2SK880-Y(T5TRICOMF)	B	89.5/46.0
Q9	1560001360	S.FET 2SK3019 TL	B	39.6/103.6
Q10	1530002851	S.TRA 2SC4116-BL(TE85RF)	B	89.5/43.5
Q11	1530002851	S.TRA 2SC4116-BL(TE85RF)	B	30.6/104.2
Q12	1590003231	S.TRA UNR9113G0L	B	66.1/100.3
Q13	1530002851	S.TRA 2SC4116-BL(TE85RF)	B	84.7/43.5
Q14	1530002851	S.TRA 2SC4116-BL(TE85RF)	B	30.6/107.1
Q15	1530002851	S.TRA 2SC4116-BL(TE85RF)	B	96.9/44.4
Q16	1530002851	S.TRA 2SC4116-BL(TE85RF)	T	35.2/108.3
Q19	1530002601	S.TRA 2SC4215-O(TE85RF)	B	63.2/106.9
Q20	1530002921	S.TRA 2SC4226-T1 Y25 (R25)	B	39.9/123.1
Q21	1530002921	S.TRA 2SC4226-T1 Y25 (R25)	B	39.6/114.5
Q22	1530002921	S.TRA 2SC4226-T1 Y25 (R25)	B	95.2/64.3
Q23	1530002921	S.TRA 2SC4226-T1 Y25 (R25)	B	95.2/54.5
Q24	1530003311	S.TRA 2SC5107-O(TE85RF)	B	100.6/58.6
Q25	1530003311	S.TRA 2SC5107-O(TE85RF)	B	44.9/117.4
Q26	1590001400	S.TRA XP1214(TX)	B	40.5/117.8
Q27	1590001400	S.TRA XP1214(TX)	B	96.0/59.6
Q28	1590003291	S.TRA UNR9213G0L	B	93.3/59.6
Q29	1590003291	S.TRA UNR9213G0L	T	57.2/41.9
Q30	1590003291	S.TRA UNR9213G0L	B	37.8/117.8
Q31	1590003231	S.TRA UNR9113G0L	T	57.2/39.8
Q32	1530003311	S.TRA 2SC5107-O(TE85RF)	B	46.2/111.7
Q33	1530003311	S.TRA 2SC5107-O(TE85RF)	B	101.9/53.0
Q34	1530003311	S.TRA 2SC5107-O(TE85RF)	B	46.2/123.1
Q35	1530003311	S.TRA 2SC5107-O(TE85RF)	B	101.9/64.4
Q36	1580000731	S.FET 3SK293(TE85LF)	B	48.3/136.6
Q37	1530003311	S.TRA 2SC5107-O(TE85RF)	B	132.4/84.5
Q38	1530002680	S.TRA 2SC3357-T1	B	139.5/86.0
Q39	1560000841	S.FET 2SK1829(TE85RF)	B	54.2/142.5
Q40	1590001190	S.TRA XP6501-(TX).AB	T	101.7/87.4
Q41	1520000460	S.TRA 2SB1132 T100 R	T	101.7/82.8
Q42	1590003291	S.TRA UNR9213G0L	T	13.3/67.6
Q43	1590003291	S.TRA UNR9213G0L	T	137.3/125.0
Q44	1590004150	S.TRA DRC9114T0L	T	114.3/80.1
Q45	1540000550	S.TRA 2SD1664 T100Q	T	118.4/75.2
Q46	1530002851	S.TRA 2SC4116-BL(TE85RF)	T	137.3/120.2
Q48	1510000920	S.TRA 2SA1577 T106 Q	T	101.5/77.8
Q49	1590003291	S.TRA UNR9213G0L	T	102.3/73.7
Q52	1590003291	S.TRA UNR9213G0L	T	10.9/131.7
Q53	1590003291	S.TRA UNR9213G0L	T	10.9/129.7
Q56	1590003560	S.FET TPC6104 (TE85LF)	T	7.7/132.7
Q57	1550000190	S.FET 2SJ506STR-E	T	123.3/99.6
Q58	1590003291	S.TRA UNR9213G0L	T	129.4/102.2
Q59	1590000990	S.TRA DTC363EK T146	T	7.7/127.6
Q61	1530002851	S.TRA 2SC4116-BL(TE85RF)	T	6.8/118.5
Q62	1540000441	S.TRA 2SD1619T-TD-E	T	118.4/18.6
Q63	1560000990	S.FET PMBFJ310	B	66.3/110.0
Q64	1560000990	S.FET PMBFJ310	B	63.4/110.0
Q65	1530003311	S.TRA 2SC5107-O(TE85RF)	B	59.6/123.7
Q66	1590003291	S.TRA UNR9213G0L	B	95.0/4.8
Q67	1590003291	S.TRA UNR9213G0L	B	125.0/4.7
Q68	1590003291	S.TRA UNR9213G0L	B	110.0/4.7
Q69	1590003291	S.TRA UNR9213G0L	T	9.5/53.3

[MAIN UNIT]

REF NO.	PARTS NO.	DESCRIPTION	M.	H/V LOCATION
Q70	1590003231	S.TRA UNR9113G0L	T	9.5/51.0
Q71	1560000990	S.FET PMBFJ310	B	60.5/110.0
Q72	1530002851	S.TRA 2SC4116-BL(TE85RF)	B	107.0/26.3
D1	1750001070	S.DIO DAN235ETL	B	57.3/78.6
D2	1750001070	S.DIO DAN235ETL	B	50.0/79.7
D3	1790001621	S.DIO 1SV308(TPL3F)	B	69.3/94.8
D4	1790001621	S.DIO 1SV308(TPL3F)	B	69.3/92.2
D5	1720000641	S.VAR 1SV284(TPH3F)	B	29.9/120.1
D7	1720000791	S.VAR HVC321B1TRF-E	B	28.6/125.1
D8	1720000791	S.VAR HVC321B1TRF-E	B	26.5/113.3
D9	1720000791	S.VAR HVC321B1TRF-E	B	84.7/59.8
D10	1720000791	S.VAR HVC321B1TRF-E	B	86.4/51.2
D11	1790001621	S.DIO 1SV308(TPL3F)	B	63.5/103.1
D12	1790001621	S.DIO 1SV308(TPL3F)	B	62.4/101.1
D13	1720000791	S.VAR HVC321B1TRF-E	B	84.9/61.8
D14	1720000791	S.VAR HVC321B1TRF-E	B	84.4/52.0
D15	1720000791	S.VAR HVC321B1TRF-E	B	28.6/122.6
D16	1720000791	S.VAR HVC321B1TRF-E	B	26.5/114.6
D17	1720000641	S.VAR 1SV284(TPH3F)	B	83.5/63.5
D18	1720000471	S.VAR 1SV239(TPH3F)	B	96.3/66.7
D19	1750000520	S.DIO DAN222TL	T	59.6/39.8
D20	1790001261	S.DIO MA2S077G0L	T	39.5/57.9
D21	1750001610	S.VAR HVC365TRF-E	B	63.0/139.4
D22	1750001610	S.VAR HVC365TRF-E	B	59.8/136.7
D23	1750001610	S.VAR HVC365TRF-E	B	63.0/136.7
D24	1750001610	S.VAR HVC365TRF-E	B	59.8/139.4
D25	1750000370	S.DIO DA221 TL	B	46.5/142.5
D26	1790001251	S.DIO MA2S1110GL	B	48.3/142.5
D27	1790001251	S.DIO MA2S1110GL	B	58.3/142.5
D30	1720000471	S.VAR 1SV239(TPH3F)	B	95.6/56.8
D31	1750001610	S.VAR HVC365TRF-E	B	34.4/135.7
D32	1750001610	S.VAR HVC365TRF-E	B	34.4/138.4
D35	1750000351	S.DIO 1SV252(TE85LF)	B	143.7/92.9
D36	1750001080	S.DIO RB886G T2R	T	144.4/120.2
D37	1750001080	S.DIO RB886G T2R	T	145.6/120.2
D38	1750001360	S.DIO L709CER (9401)	B	84.7/134.0
D39	1750000581	S.DIO 1SV307(TPH3F)	B	36.0/144.8
D40	1750000370	S.DIO DA221 TL	T	114.3/77.8
D42	1720000641	S.VAR 1SV284(TPH3F)	B	26.5/112.0
D44	1710001061	DIO L407CDB		
D45	1790001211	S.DIO 1SS375-TL-E	B	83.8/128.0
D46	1750000520	S.DIO DAN222TL	T	13.3/131.2
D47	1750000520	S.DIO DAN222TL	T	13.3/129.2
D48	1790001211	S.DIO 1SS375-TL-E	B	119.6/144.5
D49	1790001211	S.DIO 1SS375-TL-E	B	139.5/133.2
D51	1790001251	S.DIO MA2S1110GL	T	10.6/127.1
D53	1790001810	S.VAR AVR-M1005C080MTABB	T	32.5/11.7
D55	1790001810	S.VAR AVR-M1005C080MTABB	T	30.5/11.7
D56	1790001810	S.VAR AVR-M1005C080MTABB	T	36.6/11.7
D59	1790000700	DIO DSA3A1		
D61	1750000520	S.DIO DAN222TL	T	118.4/14.7
D62	1750000431	S.DIO HSB888WSTR-E	B	68.3/123.3
D63	1790001251	S.DIO MA2S1110GL	B	34.2/20.8
D64	1750000370	S.DIO DA221 TL	T	63.2/93.9
D65	1750000370	S.DIO DA221 TL	T	65.2/93.9
D66	1750000370	S.DIO DA221 TL	T	67.2/93.9
D67	1750000370	S.DIO DA221 TL	T	61.9/105.9
D68	1750000370	S.DIO DA221 TL	T	59.9/105.5
D69	1750000370	S.DIO DA221 TL	T	69.2/93.9
D70	1750000370	S.DIO DA221 TL	T	71.2/93.9
D71	1750000370	S.DIO DA221 TL	T	69.2/109.5
D72	1750000370	S.DIO DA221 TL	T	71.3/109.5
D73	1750000370	S.DIO DA221 TL	T	73.3/109.5
D74	1750000370	S.DIO DA221 TL	T	75.4/109.5
D75	1790001251	S.DIO MA2S1110GL	B	41.1/38.7
D76	1790001251	S.DIO MA2S1110GL	B	26.5/41.3
D77	1790001251	S.DIO MA2S1110GL	B	49.4/29.9
D78	1730002361	S.ZEN MAZ8062GML	B	52.3/29.9
D79	1720000641	S.VAR 1SV284(TPH3F)	B	83.1/52.0
F11	2020001520	CER CFWLA450KFFA-B0 (CFWS450F)		
F12	2020001460	CER CFWLA450KHFA-B0 (CFWS450HT)		
F13	2030000500	S.MON DSF753SFBF 46.35 MHz (FL-401)	B	72.0/101.1
F14	2030000670	S.MON DSF753SFBF 46.35 MHz (FL-420)	B	63.4/91.2
F15	2040001440	S.LC NFE31PT152Z1E9L (NFM60R20T152)	T	116.5/108.4
F16	2040001440	S.LC NFE31PT152Z1E9L (NFM60R20T152)	T	116.5/111.5
F17	2040001440	S.LC NFE31PT152Z1E9L (NFM60R20T152)	T	116.5/114.6
X1	6050012380	S.XTA CR-826 DSA535SD 15.3 MHz	B	128.6/45.3
X2	6050012380	S.XTA CR-826 DSA535SD 15.3 MHz	B	35.7/72.4
X3	6070000300	S.DIS JTBM450CX24 <JJE>	B	63.5/83.5
X4	6050012380	S.XTA CR-886 DSA321SCA 12.288 MHz	B	52.9/38.3
X5	6050012680	S.XTA CR-858(SMD-49/18.432 MHz) <JJE>	T	46.9/52.8
L1	6200004660	S.COI MLF1608A 1R8K-T	B	115.5/39.2
L2	6200004660	S.COI MLF1608A 1R8K-T	B	23.6/82.5
L3	6200004480	S.COI MLF1608D R82K-T	B	39.5/79.4

M.=Mounted side (T: Mounted on the Top side, B: Mounted on the Bottom side)
S.=Surface mount

[MAIN UNIT]

REF NO.	PARTS NO.	DESCRIPTION	M.	H/V LOCATION
L4	6200003540	S.COI MLF1608D R22K-T	B	37.0/77.0
L5	6200005691	S.COI ELJRE 18NGFA	B	102.7/45.6
L6	6200005691	S.COI ELJRE 18NGFA	B	47.3/101.1
L7	6200005661	S.COI ELJRE 10NGFA	B	44.0/99.1
L8	6200014280	S.COI BRC2012T4R7MD	B	27.0/124.1
L9	6200014280	S.COI BRC2012T4R7MD	B	27.0/120.8
L10	6200014280	S.COI BRC2012T4R7MD	B	25.9/116.8
L11	6200014280	S.COI BRC2012T4R7MD	B	82.5/61.4
L12	6200014280	S.COI BRC2012T4R7MD	B	83.1/49.9
L13	6200014280	S.COI BRC2012T4R7MD	B	28.7/111.6
L14	6200014280	S.COI BRC2012T4R7MD	B	85.3/66.4
L15	6200013220	S.COI C6342A-R13G-A	B	88.6/54.6
L16	6200010600	S.COI C6342A-67NG-A	B	33.8/122.7
L17	6200014280	S.COI BRC2012T4R7MD	B	28.7/116.8
L18	6200009910	S.COI C6342A-88NG-A	B	88.8/63.9
L19	6200014280	S.COI BRC2012T4R7MD	B	83.5/66.4
L20	6200014280	S.COI BRC2012T4R7MD	B	30.2/124.7
L21	6200009910	S.COI C6342A-88NG-A	B	33.1/114.4
L22	6200003550	S.COI MLF1608A 4R7K-T	B	73.4/109.9
L23	6200005011	S.COI NLV25T-100J	B	60.5/113.3
L24	6200010740	S.COI C2520C-R27G-A	B	70.0/109.1
L25	6200014280	S.COI BRC2012T4R7MD	B	97.4/62.5
L26	6200014280	S.COI BRC2012T4R7MD	B	98.0/56.1
L27	6130002961	S.COI #617DB-1327=P3	B	68.3/117.0
L28	6200007001	S.COI ELJRE 82NGFA	B	62.3/123.6
L29	6200006981	S.COI ELJRE R10GFA	B	102.6/58.6
L30	6200006981	S.COI ELJRE R10GFA	B	46.9/117.4
L31	6200002861	S.COI NLV25T-4R7J	T	91.2/20.0
L32	6130002961	S.COI #617DB-1327=P3	B	68.3/128.7
L33	6200005691	S.COI ELJRE 18NGFA	B	47.3/109.2
L34	6200005721	S.COI ELJRE 33NGFA	B	61.1/117.5
L35	6200005691	S.COI ELJRE 18NGFA	B	102.7/50.5
L36	6200007001	S.COI ELJRE 82NGFA	B	44.3/123.1
L37	6200005721	S.COI ELJRE 33NGFA	B	61.1/120.1
L38	6200007001	S.COI ELJRE 82NGFA	B	100.0/64.4
L39	6200010610	S.COI C6342A-50NG-A	B	67.4/138.5
L41	6200010610	S.COI C6342A-50NG-A	B	53.7/136.7
L42	6200006981	S.COI ELJRE R10GFA	B	134.5/84.5
L43	6200006671	S.COI ELJRE 68NGFA	B	138.9/90.1
L45	6200005741	S.COI ELJRE 47NGFA	B	142.8/87.4
L46	6200005741	S.COI ELJRE 47NGFA	B	142.8/90.1
L47	6200010610	S.COI C6342A-50NG-A	B	29.9/136.7
L48	6200010000	S.COI C2012C-56NG-A	B	33.3/141.2
L49	6200010050	S.COI AS080547-47N	B	97.2/119.2
L50	6200007750	S.COI LQW2BHN56NJ03L	B	85.5/137.4
L51	6200010000	S.COI C2012C-56NG-A	B	25.1/142.9
L52	6200010420	S.COI FHW1210HC 1R0JGT <JJE>	B	86.6/122.4
L53	6200010050	S.COI AS080547-47N	B	90.1/135.3
L55	6200010050	S.COI AS080547-47N	B	107.6/135.0
L56	6200010050	S.COI AS080547-47N	B	115.2/138.8
L57	6200010050	S.COI AS080547-47N	B	143.7/140.9
L58	6200002861	S.COI NLV25T-4R7J	T	55.4/37.5
L59	6200010420	S.COI FHW1210HC 1R0JGT <JJE>	B	147.2/146.2
L60	6200010420	S.COI FHW1210HC 1R0JGT <JJE>	B	24.5/147.0
L61	6200002961	S.COI NLV32T-4R7J	T	118.4/23.8
L62	6200014280	S.COI BRC2012T4R7MD	B	83.7/56.6
L63	6200010000	S.COI C2012C-56NG-A	B	72.3/137.8
L64	6200014280	S.COI BRC2012T4R7MD	B	81.8/54.9
L65	6200014280	S.COI BRC2012T4R7MD	B	41.7/120.7
L66	6200014280	S.COI BRC2012T4R7MD	B	42.4/115.3
L68	6200003960	S.COI MLF1608A 1R0K-T	B	140.7/94.7
L69	6200005661	S.COI ELJRE 10NGFA	B	102.7/42.3
R1	7030005310	S.RES ERJ2GEJ 124 X (120K)	T	54.9/64.1
R2	7030005050	S.RES ERJ2GEJ 103 X (10K)	T	58.7/61.7
R3	7030005240	S.RES ERJ2GEJ 473 X (47K)	T	62.4/69.6
R4	7030007340	S.RES ERJ2GEJ 153 X (15K)	B	57.3/80.1
R6	7030007300	S.RES ERJ2GEJ 332 X (3.3K)	T	9.5/57.1
R7	7030010040	S.RES ERJ2GEJ-JPW	T	61.6/66.3
R8	7030005160	S.RES ERJ2GEJ 105 X (1M)	T	24.9/70.4
R9	7030005160	S.RES ERJ2GEJ 105 X (1M)	T	25.8/70.4
R10	7030005160	S.RES ERJ2GEJ 105 X (1M)	T	26.7/70.4
R12	7510001730	S.THE ERTJJOEP 473J	B	129.1/49.3
R13	7030005090	S.RES ERJ2GEJ 104 X (100K)	B	130.8/49.3
R15	7030007340	S.RES ERJ2GEJ 153 X (15K)	B	54.6/78.3
R17	7030004980	S.RES ERJ2GEJ 101 X (100)	T	19.8/68.9
R18	7030007340	S.RES ERJ2GEJ 153 X (15K)	B	55.4/79.2
R20	7030009150	S.RES ERJ2GEJ 824 X (820K)	T	56.1/63.5
R22	7410001130	S.ARR EXB28V102JX	B	122.6/39.0
R23	7410001130	S.ARR EXB28V102JX	B	23.2/76.4
R24	7030005120	S.RES ERJ2GEJ 102 X (1K)	B	115.5/42.2
R25	7030004970	S.RES ERJ2GEJ 470 X (47)	B	65.3/79.4
R26	7030010040	S.RES ERJ2GEJ-JPW	T	57.7/64.5
R27	7030005120	S.RES ERJ2GEJ 102 X (1K)	T	57.9/51.0
R29	7030007570	S.RES ERJ2GEJ 122 X (1.2K)	B	38.5/75.9
R30	7030007340	S.RES ERJ2GEJ 153 X (15K)	B	52.8/81.2
R32	7030007340	S.RES ERJ2GEJ 153 X (15K)	B	51.3/78.4
R33	7030007340	S.RES ERJ2GEJ 153 X (15K)	B	48.5/78.2
R34	7030005240	S.RES ERJ2GEJ 473 X (47K)	T	27.1/68.1
R35	7030005240	S.RES ERJ2GEJ 473 X (47K)	T	28.0/68.1
R36	7030005240	S.RES ERJ2GEJ 473 X (47K)	T	28.9/68.1
R38	7030005230	S.RES ERJ2GEJ 334 X (330K)	T	27.7/70.4
R39	7030005230	S.RES ERJ2GEJ 334 X (330K)	T	28.6/70.4
R40	7030005230	S.RES ERJ2GEJ 334 X (330K)	T	29.5/70.4
R41	7030005110	S.RES ERJ2GEJ 224 X (220K)	B	68.2/78.2
R42	7030006610	S.RES ERJ2GEJ 394 X (390K)	B	34.4/75.5
R43	7030007290	S.RES ERJ2GEJ 222 X (2.2K)	B	62.8/77.2
R44	7030005030	S.RES ERJ2GEJ 152 X (1.5K)	B	71.4/78.2
R45	7030005040	S.RES ERJ2GEJ 472 X (4.7K)	B	64.6/75.5
R46	7030005000	S.RES ERJ2GEJ 471 X (470)	T	52.7/57.1
R47	7030005720	S.RES ERJ2GEJ 563 X (56K)	B	64.6/76.4
R48	7030005030	S.RES ERJ2GEJ 152 X (1.5K)	B	62.8/76.4
R49	7030010040	S.RES ERJ2GEJ-JPW	T	55.6/57.3
R52	7030004980	S.RES ERJ2GEJ 101 X (100)	B	34.1/56.5

[MAIN UNIT]

REF NO.	PARTS NO.	DESCRIPTION	M.	H/V LOCATION
R53	7030005210	S.RES ERJ2GEJ 822 X (8.2K)	B	16.8/57.6
R54	7030005000	S.RES ERJ2GEJ 471 X (470)	B	19.5/64.3
R56	7030004970	S.RES ERJ2GEJ 470 X (47)	B	121.9/50.4
R57	7030005040	S.RES ERJ2GEJ 472 X (4.7K)	B	62.8/75.5
R58	7030008290	S.RES ERJ2GEJ 183 X (18K)	B	56.5/49.0
R59	7030008290	S.RES ERJ2GEJ 183 X (18K)	B	57.4/49.0
R60	7030005000	S.RES ERJ2GEJ 471 X (470)	B	32.3/74.3
R62	7030005120	S.RES ERJ2GEJ 102 X (1K)	B	18.5/62.5
R63	7030005090	S.RES ERJ2GEJ 104 X (100K)	T	55.6/60.5
R65	7030005000	S.RES ERJ2GEJ 471 X (470)	B	125.1/47.3
R66	7030004980	S.RES ERJ2GEJ 101 X (100)	B	56.5/50.6
R68	7030005040	S.RES ERJ2GEJ 472 X (4.7K)	B	67.5/86.8
R69	7030005120	S.RES ERJ2GEJ 102 X (1K)	B	32.7/83.0
R70	7030005050	S.RES ERJ2GEJ 103 X (10K)	B	69.8/71.9
R71	7030005240	S.RES ERJ2GEJ 473 X (47K)	B	31.1/62.6
R72	7030004980	S.RES ERJ2GEJ 101 X (100)	B	57.6/44.2
R73	7030010040	S.RES ERJ2GEJ-JPW	B	28.3/100.4
R74	7030005120	S.RES ERJ2GEJ 102 X (1K)	B	56.8/83.5
R75	7030005110	S.RES ERJ2GEJ 224 X (220K)	B	39.9/71.1
R76	7030010040	S.RES ERJ2GEJ-JPW	B	93.7/41.6
R77	7030005580	S.RES ERJ2GEJ 560 X (56)	B	119.7/48.8
R78	7030010040	S.RES ERJ2GEJ-JPW	B	29.9/99.3
R79	7030005580	S.RES ERJ2GEJ 560 X (56)	B	32.7/79.5
R80	7030004970	S.RES ERJ2GEJ 470 X (47)	B	23.5/41.1
R81	7030007250	S.RES ERJ2GEJ 220 X (22)	B	49.9/50.5
R82	7030008400	S.RES ERJ2GEJ 182 X (1.8K)	B	56.0/44.2
R83	7030010040	S.RES ERJ2GEJ-JPW	B	32.4/106.5
R84	7030007290	S.RES ERJ2GEJ 222 X (2.2K)	B	93.7/47.1
R85	7030007290	S.RES ERJ2GEJ 222 X (2.2K)	B	37.8/107.1
R86	7030010040	S.RES ERJ2GEJ-JPW	B	33.2/105.2
R87	7030005090	S.RES ERJ2GEJ 104 X (100K)	B	73.8/81.2
R88	7030005530	S.RES ERJ2GEJ 100 X (10)	B	39.0/71.1
R89	7030008400	S.RES ERJ2GEJ 182 X (1.8K)	B	67.2/83.2
R90	7030008010	S.RES ERJ2GEJ 123 X (12K)	T	54.5/73.3
R91	7030007290	S.RES ERJ2GEJ 222 X (2.2K)	B	92.1/47.1
R92	7030009140	S.RES ERJ2GEJ 272 X (2.7K)	B	92.1/41.6
R93	7030007290	S.RES ERJ2GEJ 222 X (2.2K)	B	37.8/106.1
R94	7030009140	S.RES ERJ2GEJ 272 X (2.7K)	B	28.3/98.3
R97	7410001170	S.ARR EXB28V470JX	B	42.9/49.9
R98	7030005530	S.RES ERJ2GEJ 100 X (10)	B	71.0/95.7
R99	7030005110	S.RES ERJ2GEJ 224 X (220K)	B	71.0/92.9
R100	7030005600	S.RES ERJ2GEJ 273 X (27K)	B	67.9/93.8
R101	7030004980	S.RES ERJ2GEJ 101 X (100)	B	92.1/46.2
R102	7030004980	S.RES ERJ2GEJ 101 X (100)	B	34.8/105.2
R103	7030004980	S.RES ERJ2GEJ 101 X (100)	B	28.3/101.3
R105	7030005050	S.RES ERJ2GEJ 103 X (10K)	B	33.7/107.9
R107	7030004980	S.RES ERJ2GEJ 101 X (100)	B	87.1/47.1
R109	7030005090	S.RES ERJ2GEJ 104 X (100K)	B	64.8/98.2
R111	7030005090	S.RES ERJ2GEJ 104 X (100K)	B	37.8/104.4
R112	7030005070	S.RES ERJ2GEJ 683 X (68K)	B	84.7/43.5
R113	7030005070	S.RES ERJ2GEJ 683 X (68K)	B	32.4/108.1
R114	7030007300	S.RES ERJ2GEJ 332 X (3.3K)	B	67.4/96.2
R115	7030007300	S.RES ERJ2GEJ 332 X (3.3K)	B	67.9/91.3
R116	7030005050	S.RES ERJ2GEJ 103 X (10K)	B	87.1/45.3
R117	7030005810	S.RES RR0510P-152-D (1.5K)	B	87.1/46.2
R118	7030007280	S.RES ERJ2GEJ 331 X (330)	B	72.8/94.8
R119	7030007270	S.RES ERJ2GEJ 151 X (150)	B	68.1/89.0
R120	7030005810	S.RES RR0510P-152-D (1.5K)	B	33.7/107.0
R121	7030008400	S.RES ERJ2GEJ 182 X (1.8K)	B	27.3/108.7
R122	7030004970	S.RES ERJ2GEJ 470 X (47)	B	56.7/33.9
R123	7030004970	S.RES ERJ2GEJ 470 X (47)	B	49.5/38.5
R124	7030005240	S.RES ERJ2GEJ 473 X (47K)	B	55.3/38.3
R125	7030008280	S.RES ERJ2GEJ 271 X (270)	B	84.7/46.2
R126	7030007290	S.RES ERJ2GEJ 222 X (2.2K)	B	96.5/42.6
R127	7030005720	S.RES ERJ2GEJ 563 X (56K)	T	88.4/58.4
R128	7030007290	S.RES ERJ2GEJ 222 X (2.2K)	T	33.4/108.3
R129	7030005240	S.RES ERJ2GEJ 473 X (47K)	B	55.3/35.1
R130	7030005240	S.RES ERJ2GEJ 473 X (47K)	B	56.2/36.7
R131	7030004980	S.RES ERJ2GEJ 101 X (100)	B	54.3/32.5
R132	7030007290	S.RES ERJ2GEJ 222 X (2.2K)	B	50.8/34.9
R133	7030007280	S.RES ERJ2GEJ 331 X (330)	B	67.6/104.4
R134	7030007270	S.RES ERJ2GEJ 151 X (150)	B	62.4/97.1
R136	7030005110	S.RES ERJ2GEJ 224 X (220K)	B	81.8/65.5
R137	7030005110	S.RES ERJ2GEJ 224 X (220K)	B	81.8/57.0
R138	7030005240	S.RES ERJ2GEJ 473 X (47K)	T	95.3/65.8
R139	7030005060	S.RES ERJ2GEJ 333 X (33K)	T	95.3/64.9
R140	7030007300	S.RES ERJ2GEJ 332 X (3.3K)	B	63.9/100.3
R141	7030005060	S.RES ERJ2GEJ 333 X (33K)	T	95.3/64.0
R142	7030007300	S.RES ERJ2GEJ 332 X (3.3K)	B	65.4/102.5
R143	7030005240	S.RES ERJ2GEJ 473 X (47K)	B	48.6/38.5
R144	7030005240	S.RES ERJ2GEJ 473 X (47K)	B	48.6/36.9
R145	7030010040			

[MAIN UNIT]

REF NO.	PARTS NO.	DESCRIPTION	M.	H/V LOCATION
R173	7030009820	S.RES RR0510P-681-D (680)	B	97.2/53.7
R174	7030009820	S.RES RR0510P-681-D (680)	B	42.1/113.8
R175	7030005530	S.RES ERJ2GEJ 100 X (10)	B	73.6/111.0
R176	7030005090	S.RES ERJ2GEJ 104 X (100K)	B	100.6/56.8
R177	7030005090	S.RES ERJ2GEJ 104 X (100K)	B	44.9/115.4
R178	7030004980	S.RES ERJ2GEJ 101 X (100)	B	100.6/55.9
R179	7030004980	S.RES ERJ2GEJ 101 X (100)	B	44.9/114.7
R180	7030005050	S.RES ERJ2GEJ 103 X (10K)	T	37.0/108.3
R181	7030005050	S.RES ERJ2GEJ 103 X (10K)	B	96.4/49.0
R184	7030008280	S.RES ERJ2GEJ 271 X (270)	B	63.2/119.1
R185	7030010090	S.RES ERJ2GEJ 180 X (18)	B	62.3/117.5
R186	7030005120	S.RES ERJ2GEJ 102 X (1K)	T	39.2/50.8
R187	7030008010	S.RES ERJ2GEJ 123 X (12K)	T	41.5/55.9
R188	7410001150	S.ARR EXB28V471JX	T	48.6/41.1
R189	7030005090	S.RES ERJ2GEJ 104 X (100K)	T	55.7/39.6
R190	7030008010	S.RES ERJ2GEJ 123 X (12K)	T	43.1/55.9
R191	7030005000	S.RES ERJ2GEJ 471 X (470)	B	43.5/112.2
R192	7030005110	S.RES ERJ2GEJ 224 X (220K)	B	44.4/112.2
R193	7030008280	S.RES ERJ2GEJ 271 X (270)	B	59.6/116.8
R194	7030004980	S.RES ERJ2GEJ 101 X (100)	B	99.2/53.0
R195	7030005110	S.RES ERJ2GEJ 224 X (220K)	B	100.1/53.0
R196	7030009320	S.RES ERJ2GEJ 4R7 X (4.7)	B	48.0/120.7
R197	7030005050	S.RES ERJ2GEJ 103 X (10K)	T	40.5/50.6
R198	7030009320	S.RES ERJ2GEJ 4R7 X (4.7)	B	103.7/62.0
R199	7030005050	S.RES ERJ2GEJ 103 X (10K)	T	67.6/57.3
R200	7030004980	S.RES ERJ2GEJ 101 X (100)	B	43.1/123.1
R201	7030005090	S.RES ERJ2GEJ 104 X (100K)	B	48.0/122.6
R202	7030005160	S.RES ERJ2GEJ 105 X (1M)	T	41.4/48.6
R204	7030005050	S.RES ERJ2GEJ 103 X (10K)	T	54.8/39.6
R205	7030008010	S.RES ERJ2GEJ 123 X (12K)	T	36.5/57.9
R207	7030005090	S.RES ERJ2GEJ 104 X (100K)	B	103.7/64.0
R208	7030010040	S.RES ERJ2GEJ-JPW	B	46.2/120.7
R209	7030005000	S.RES ERJ2GEJ 471 X (470)	T	67.6/56.5
R212	7410001140	S.ARR EXB28V104JX	T	52.4/41.1
R213	7030005530	S.RES ERJ2GEJ 100 X (10)	T	41.4/47.7
R214	7030004980	S.RES ERJ2GEJ 101 X (100)	B	98.9/64.0
R215	7030010040	S.ARR ERJ2GEJ-JPW	T	100.9/62.0
R216	7410001140	S.ARR EXB28V104JX	T	17.3/52.4
R217	7410001140	S.ARR EXB28V104JX	T	38.6/56.0
R218	7030005090	S.RES ERJ2GEJ 104 X (100K)	B	61.4/138.5
R220	7410001140	S.ARR EXB28V104JX	T	15.2/50.7
R222	7410001140	S.ARR EXB28V104JX	T	36.1/56.0
R223	7030005050	S.RES ERJ2GEJ 103 X (10K)	B	61.4/137.6
R224	7410001150	S.ARR EXB28V471JX	T	30.5/53.1
R225	7030005090	S.RES ERJ2GEJ 104 X (100K)	B	61.4/139.4
R226	7030005110	S.RES ERJ2GEJ 224 X (220K)	B	39.9/72.7
R227	7410001150	S.ARR EXB28V471JX	T	42.9/29.0
R230	7410001150	S.ARR EXB28V471JX	T	28.7/50.9
R231	7030005000	S.RES ERJ2GEJ 471 X (470)	B	58.2/139.4
R232	7410001150	S.ARR EXB28V471JX	T	26.0/49.4
R233	7030004980	S.RES ERJ2GEJ 101 X (100)	B	58.2/135.8
R234	7410001150	S.ARR EXB28V471JX	T	42.6/25.8
R235	7410001150	S.ARR EXB28V471JX	T	24.2/47.6
R236	7030005090	S.RES ERJ2GEJ 104 X (100K)	B	132.4/82.7
R237	7030005530	S.RES ERJ2GEJ 100 X (10)	B	49.4/138.8
R238	7410001150	S.ARR EXB28V471JX	T	45.8/29.0
R239	7410001150	S.ARR EXB28V471JX	T	22.4/45.9
R240	7030004980	S.RES ERJ2GEJ 101 X (100)	B	134.7/86.7
R241	7030004990	S.RES ERJ2GEJ 221 X (220)	B	49.4/134.3
R242	7030009320	S.RES ERJ2GEJ 4R7 X (4.7)	B	48.4/138.8
R243	7030005090	S.RES ERJ2GEJ 104 X (100K)	B	47.4/138.8
R244	7410001150	S.ARR EXB28V471JX	T	39.7/25.8
R245	7410001150	S.ARR EXB28V471JX	T	20.3/42.5
R246	7030005310	S.RES ERJ2GEJ 124 X (120K)	B	45.6/136.6
R247	7030005720	S.RES ERJ2GEJ 563 X (56K)	B	48.4/140.4
R249	7030008010	S.RES ERJ2GEJ 123 X (12K)	B	135.6/88.4
R250	7030004980	S.RES ERJ2GEJ 101 X (100)	B	133.8/90.1
R251	7030006610	S.RES ERJ2GEJ 394 X (390K)	B	49.4/142.5
R252	7030010040	S.RES ERJ2GEJ-JPW	B	132.0/86.7
R253	7030004970	S.RES ERJ2GEJ 470 X (47)	B	136.5/90.1
R255	7030005040	S.RES ERJ2GEJ 472 X (4.7K)	B	52.4/142.5
R256	7030005040	S.RES ERJ2GEJ 472 X (4.7K)	B	137.7/82.0
R257	7410001140	S.ARR EXB28V104JX	T	14.5/45.7
R259	7030005170	S.RES ERJ2GEJ 474 X (470K)	B	57.1/142.5
R260	7030007290	S.RES ERJ2GEJ 222 X (2.2K)	B	108.8/25.3
R261	7030005050	S.RES ERJ2GEJ 103 X (10K)	T	52.6/25.3
R262	7030005090	S.RES ERJ2GEJ 104 X (100K)	T	50.2/22.8
R263	7410001140	S.ARR EXB28V104JX	T	46.3/20.1
R264	7410001140	S.ARR EXB28V104JX	T	50.2/24.0
R265	7030010040	S.RES ERJ2GEJ-JPW	B	87.1/43.5
R267	7410001140	S.ARR EXB28V104JX	T	15.0/42.5
R268	7410001150	S.ARR EXB28V471JX	T	45.7/31.8
R269	7030004980	S.RES ERJ2GEJ 101 X (100)	B	143.2/94.7
R270	7030005050	S.RES ERJ2GEJ 103 X (10K)	B	36.0/136.6
R271	7030005090	S.RES ERJ2GEJ 104 X (100K)	T	23.8/26.7
R272	7410001150	S.ARR EXB28V471JX	T	17.9/32.3
R273	7410001150	S.ARR EXB28V471JX	T	18.0/35.1
R274	7030005090	S.RES ERJ2GEJ 104 X (100K)	B	36.0/137.5
R275	7030005060	S.RES ERJ2GEJ 333 X (33K)	T	93.1/55.7
R276	7030010040	S.RES ERJ2GEJ-JPW	B	87.1/44.4
R277	7030004980	S.RES ERJ2GEJ 101 X (100)	T	145.0/126.0
R278	7030005090	S.RES ERJ2GEJ 104 X (100K)	T	14.0/65.6
R279	7030007290	S.RES ERJ2GEJ 222 X (2.2K)	T	102.4/90.1
R280	7030004990	S.RES ERJ2GEJ 221 X (220)	T	141.3/127.7
R281	7410001150	S.ARR EXB28V471JX	T	21.3/31.8
R282	7030005090	S.RES ERJ2GEJ 104 X (100K)	T	37.9/20.4
R283	7030005100	S.RES ERJ2GEJ 154 X (150K)	T	144.0/124.4
R285	7030005050	S.RES ERJ2GEJ 103 X (10K)	T	101.7/79.6
R286	7030005080	S.RES ERJ2GEJ 823 X (82K)	B	40.8/72.7
R287	7410001140	S.ARR EXB28V104JX	T	49.7/27.7
R288	7030007340	S.RES ERJ2GEJ 153 X (15K)	T	139.5/122.5
R289	7030006070	S.RES ERJ12YJ101U (100)	B	87.0/117.6
R290	7030005050	S.RES ERJ2GEJ 103 X (10K)	T	138.6/122.5
R291	7030005040	S.RES ERJ2GEJ 472 X (4.7K)	T	137.6/127.7
R292	7030005050	S.RES ERJ2GEJ 103 X (10K)	T	144.0/126.0

[MAIN UNIT]

REF NO.	PARTS NO.	DESCRIPTION	M.	H/V LOCATION
R293	7030004980	S.RES ERJ2GEJ 101 X (100)	B	136.5/83.3
R294	7030004980	S.RES ERJ2GEJ 101 X (100)	B	136.5/85.0
R295	7030005090	S.RES ERJ2GEJ 104 X (100K)	T	137.6/122.5
R296	7030000440	S.RES MCR10EZHJ 3.3K (332)	T	118.4/79.6
R297	7030000440	S.RES MCR10EZHJ 3.3K (332)	T	120.2/79.6
R298	7030000440	S.RES MCR10EZHJ 3.3K (332)	T	116.6/79.6
R299	7030004980	S.RES ERJ2GEJ 101 X (100)	B	29.1/19.4
R300	7030005530	S.RES ERJ2GEJ 100 X (10)	T	47.6/73.1
R301	7030008300	S.RES ERJ2GEJ 184 X (180K)	B	85.6/105.6
R302	7030005590	S.RES ERJ2GEJ 680 X (68)	B	135.6/85.0
R303	7410001150	S.ARR EXB28V471JX	T	47.7/68.4
R304	7030005050	S.RES ERJ2GEJ 103 X (10K)	B	84.3/130.0
R306	7520000261	S.POS PRF18BB471QB5RB	B	84.4/104.4
R308	7030005070	S.RES ERJ2GEJ 683 X (68K)	T	144.0/127.7
R309	7030005040	S.RES ERJ2GEJ 472 X (4.7K)	T	102.3/75.7
R310	7030005030	S.RES ERJ2GEJ 152 X (1.5K)	T	143.3/120.2
R311	7030008410	S.RES ERJ2GEJ 392 X (3.9K)	T	145.0/122.5
R312	7030005050	S.RES ERJ2GEJ 103 X (10K)	T	146.8/120.2
R313	7030005050	S.RES ERJ2GEJ 103 X (10K)	T	103.5/77.8
R314	7030007280	S.RES ERJ2GEJ 331 X (330)	T	146.0/124.4
R315	7030005700	S.RES ERJ2GEJ 274 X (270K)	B	86.0/128.9
R316	7030005050	S.RES ERJ2GEJ 103 X (10K)	T	11.2/128.2
R317	7030005010	S.RES ERJ2GEJ 681 X (68)	B	138.5/94.7
R318	7030003260	S.RES ERJ3GEYJ 330 V (330)	B	140.2/90.1
R320	7030005090	S.RES ERJ2GEJ 104 X (100K)	T	15.1/124.2
R321	7030003370	S.RES ERJ3GEYJ 271 V (270)	B	119.6/141.7
R322	7030005600	S.RES ERJ2GEJ 273 X (27K)	B	121.5/143.4
R324	7030005050	S.RES ERJ2GEJ 102 X (10K)	B	31.3/12.0
R325	7030005120	S.RES ERJ2GEJ 103 X (1K)	B	32.3/12.0
R326	7030005240	S.RES ERJ2GEJ 473 X (47K)	T	13.2/125.8
R327	7030000260	S.RES MCR10EZHJ 100 (101)	B	119.7/132.9
R328	7030000280	S.RES MCR10EZHJ 150 (151)	B	139.3/144.4
R331	7030004980	S.RES ERJ2GEJ 101 X (100)	T	12.0/120.0
R332	7030003370	S.RES ERJ3GEYJ 271 V (270)	B	139.5/136.0
R333	7030005600	S.RES ERJ2GEJ 273 X (27K)	B	137.7/131.9
R334	7030005651	S.RES ERA3YKD 304 V (300K)	T	57.8/30.5
R335	7030005871	S.RES ERA3YKD 104V (100K)	T	55.9/29.8
R336	7030005110	S.RES ERJ2GEJ 224 X (220K)	T	12.0/120.0
R337	7030005110	S.RES ERJ2GEJ 224 X (220K)	T	13.2/120.6
R339	7030005090	S.RES ERJ2GEJ 104 X (100K)	T	12.0/125.3
R341	7030005050	S.RES ERJ2GEJ 103 X (10K)	B	33.3/12.0
R342	7030005090	S.RES ERJ2GEJ 104 X (100K)	B	45.3/56.9
R346	7410001150	S.ARR EXB28V471JX	T	43.6/73.8
R347	7030005040	S.RES ERJ2GEJ 472 X (4.7K)	T	9.9/132.9
R348	7030000620	S.RES MCR10EZHJ 100 K (104)	B	147.3/150.9
R349	7030000620	S.RES MCR10EZHJ 100 K (104)	B	26.0/149.7
R350	7030003560	S.RES ERJ3GEYJ 103 V (10K)	B	6.4/31.1
R352	7030005040	S.RES ERJ2GEJ 472 X (4.7K)	T	10.7/125.5
R353	7030005240	S.RES ERJ2GEJ 473 X (47K)	B	55.8/56.9
R354	7030005700	S.RES ERJ2GEJ 274 X (270K)	T	123.3/103.0
R355	7030005090	S.RES ERJ2GEJ 104 X (100K)	T	127.4/102.2
R356	7030005090	S.RES ERJ2GEJ 104 X (100K)	T	9.9/134.5
R357	7030003560	S.RES ERJ3GEYJ 103 V (10K)	B	10.2/150.2
R362	7540000290	ABS ERZV10D220		
R364	7030005110	S.RES ERJ2GEJ 224 X (220K)	T	65.1/71.2
R365	7030005050	S.RES ERJ2GEJ 103 X (10K)	T	7.5/120.7
R366	7030007290	S.RES ERJ2GEJ 222 X (2.2K)	T	6.2/127.7
R367	7030004980	S.RES ERJ2GEJ 101 X (100)	T	9.8/117.3
R368	7030008300	S.RES ERJ2GEJ 184 X (180K)	T	8.6/117.8
R369	7030005230	S.RES ERJ2GEJ 334 X (330K)	T	9.8/118.2
R370	7030008280	S.RES ERJ2GEJ 271 X (270)	T	6.2/120.7
R371	7030010040	S.RES ERJ2GEJ-JPW	T	5.1/117.3
R372	7030005000	S.RES ERJ2GEJ 471 X (470)	T	115.3/15.8
R373	7030005050	S.RES ERJ2GEJ 103 X (10K)	T	115.3/14.0
R374	7030000140	S.RES MCR10EZHJ 10 (100)	T	111.2/12.3
R375	7030010040	S.RES ERJ2GEJ-JPW	T	100.1/16.3
R376	7030004980	S.RES ERJ2GEJ 101 X (100)	B	62.3/122.2
R378	7030005210	S.RES ERJ2GEJ 822 X (8.2K)	B	63.2/126.1
R379	7030005210	S.RES ERJ2GEJ 822 X (8.2K)	B	59.6/126.1
R380	7030007260	S.RES ERJ2GEJ 330 X (33)	B	57.8/123.7
R381	7030005570	S.RES ERJ2GEJ 820 X (82)	B	61.4/126.1
R424	7410001150	S.ARR EXB28V471JX	T	46.3/42.9
R425	7410001150	S.ARR EXB28V471JX	T	36.9/23.0
R426	7410001150	S.ARR EXB28V471JX	T	47.8/34.0
R427	7030005000	S.RES ERJ2GEJ 471 X (470)	T	25.5/26.7
R428	7410001140			

[MAIN UNIT]

REF NO.	PARTS NO.	DESCRIPTION	M.	H/V LOCATION
R475	7030005000	S.RES ERJ2GEJ 471 X (470)	B	9.0/56.2
R476	7030008270	S.RES RR0510P-104-D (100K)	B	15.0/53.5
R477	7030005860	S.RES RR0510P-823-D (82K)	B	15.0/52.6
R478	7030005050	S.RES ERJ2GEJ 103 X (10K)	B	9.2/54.8
R479	7030005110	S.RES ERJ2GEJ 224 X (220K)	T	64.2/69.6
R480	7030005050	S.RES ERJ2GEJ 103 X (10K)	B	15.6/61.5
R481	7030005050	S.RES ERJ2GEJ 103 X (10K)	B	16.5/59.9
R482	7410001150	S.ARR EXB28V471JX	T	19.6/45.2
R483	7030005090	S.RES ERJ2GEJ 104 X (100K)	T	31.3/56.5
R484	7030005090	S.RES ERJ2GEJ 104 X (100K)	B	28.8/50.9
R485	7410001150	S.ARR EXB28V471JX	T	67.3/96.9
R486	7410001150	S.ARR EXB28V471JX	T	63.9/107.0
R487	7410001150	S.ARR EXB28V471JX	T	73.0/106.9
R488	7030005000	S.RES ERJ2GEJ 471 X (470)	T	9.5/54.9
R489	7030004980	S.RES ERJ2GEJ 101 X (100)	B	24.1/58.7
R490	7030008290	S.RES ERJ2GEJ 183 X (18K)	B	28.3/58.4
R491	7030004980	S.RES ERJ2GEJ 101 X (100)	B	26.1/51.2
R492	7030005240	S.RES ERJ2GEJ 473 X (47K)	B	29.9/58.9
R493	7030010040	S.RES ERJ2GEJ-JPW	T	11.3/19.0
R494	7030005000	S.RES ERJ2GEJ 471 X (470)	T	73.3/99.0
R495	7030008270	S.RES RR0510P-104-D (100K)	T	54.9/55.3
R496	7030006020	S.RES RR0510P-682-D (6.8K)	T	52.7/56.2
R497	7030008250	S.RES RR0510P-562-D (5.6K)	T	52.7/55.3
R498	7030005600	S.RES ERJ2GEJ 273 X (27K)	B	61.4/103.1
R499	7030004980	S.RES ERJ2GEJ 101 X (100)	T	24.4/57.0
R500	7030005600	S.RES ERJ2GEJ 273 X (27K)	T	21.2/57.5
R501	7030005220	S.RES ERJ2GEJ 223 X (22K)	T	22.8/53.8
R502	7030005090	S.RES ERJ2GEJ 104 X (100K)	T	28.0/55.0
R503	7030007350	S.RES ERJ2GEJ 393 X (39K)	T	55.6/58.9
R504	7030011920	S.RES RR0510P-561-D (560)	T	52.7/54.4
R505	7030010040	S.RES ERJ2GEJ-JPW	T	113.4/18.3
R506	7030005110	S.RES ERJ2GEJ 224 X (220K)	T	113.4/19.3
R507	7030005090	S.RES ERJ2GEJ 104 X (100K)	T	115.0/19.3
R508	7030010040	S.RES ERJ2GEJ-JPW	B	93.7/42.6
R509	7030005050	S.RES ERJ2GEJ 103 X (10K)	B	33.3/15.2
R510	7030007350	S.RES ERJ2GEJ 393 X (39K)	B	29.0/14.1
R511	7030005050	S.RES ERJ2GEJ 103 X (10K)	B	29.1/18.5
R512	7030005050	S.RES ERJ2GEJ 103 X (10K)	B	30.8/18.5
R513	7030007280	S.RES ERJ2GEJ 331 X (330)	B	72.6/91.0
R530	7030005240	S.RES ERJ2GEJ 473 X (47K)	T	62.5/66.3
R532	7030005000	S.RES ERJ2GEJ 471 X (470)	B	45.1/37.1
R533	7030005090	S.RES ERJ2GEJ 104 X (100K)	T	57.2/18.4
R534	7030005600	S.RES ERJ2GEJ 273 X (27K)	B	45.3/58.6
R535	7030004980	S.RES ERJ2GEJ 101 X (100)	B	56.7/56.9
R536	7030005600	S.RES ERJ2GEJ 273 X (27K)	B	55.8/58.6
R537	7030010040	S.RES ERJ2GEJ-JPW	B	41.6/41.2
R539	7030005110	S.RES ERJ2GEJ 224 X (220K)	T	64.2/71.2
R540	7030005090	S.RES ERJ2GEJ 104 X (100K)	T	90.6/17.9
R541	7030005220	S.RES ERJ2GEJ 223 X (22K)	T	28.9/55.0
R542	7030005120	S.RES ERJ2GEJ 102 X (1K)	T	70.4/65.1
R545	7030010040	S.RES ERJ2GEJ-JPW	T	61.2/98.7
R546	7030010040	S.RES ERJ2GEJ-JPW	T	61.2/99.6
R547	7030010040	S.RES ERJ2GEJ-JPW	T	69.7/99.1
R548	7030009140	S.RES ERJ2GEJ 272 X (2.7K)	T	78.7/139.0
R549	7030001070	S.RES MCR50JZHJ 33 (330)	B	87.6/30.2
R550	7030001070	S.RES MCR50JZHJ 33 (330)	T	87.6/33.3
C1	4030017420	S.CER C1005 CH 1H 470J-T	B	120.7/39
C2	4030017420	S.CER C1005 CH 1H 470J-T	B	22.9/78.7
C3	4030016930	S.CER C1005 JB 1A 104K-T	B	130.8/50.2
C4	4030017420	S.CER C1005 CH 1H 470J-T	B	121.9/37.1
C5	4030017420	S.CER C1005 CH 1H 470J-T	B	21.7/77.2
C6	4030016930	S.CER C1005 JB 1A 104K-T	B	52.5/78.0
C7	4030017420	S.CER C1005 CH 1H 470J-T	B	122.8/37.1
C8	4030017420	S.CER C1005 CH 1H 470J-T	T	21.7/75.6
C9	4030017460	S.CER C1005 JB 1H 102K-T	B	17.6/59.0
C10	4030016930	S.CER C1005 JB 1A 104K-T	B	55.8/78.0
C11	4030016930	S.CER C1005 JB 1A 104K-T	B	123.7/37.1
C12	4030016930	S.CER C1005 JB 1A 104K-T	B	22.1/74.4
C13	4030016930	S.CER C1005 JB 1A 104K-T	B	55.6/80.7
C14	4030017460	S.CER C1005 JB 1H 102K-T	T	16.1/59.9
C15	4030016930	S.CER C1005 JB 1A 104K-T	T	62.4/67.5
C17	4030016930	S.CER C1005 JB 1A 104K-T	B	115.5/40.6
C18	4030017430	S.CER C1005 CH 1H 101J-T	T	62.4/71.2
C19	4030016930	S.CER C1005 JB 1A 104K-T	B	22.9/80.4
C20	4550006250	S.TAN TEESVA 1A 106M8R	B	115.3/37.5
C21	4550006250	S.TAN TEESVA 1A 106M8R	B	21.4/80.5
C22	4030016930	S.CER C1005 JB 1A 104K-T	B	50.1/78.0
C23	4030016930	S.CER C1005 JB 1A 104K-T	T	57.9/52.7
C24	4030016930	S.CER C1005 JB 1A 104K-T	B	50.3/81.2
C25	4030016930	S.CER C1005 JB 1A 104K-T	B	54.4/81.2
C26	4030017460	S.CER C1005 JB 1H 102K-T	B	117.8/39.2
C27	4030017460	S.CER C1005 JB 1H 102K-T	B	23.8/80.4
C28	4030016930	S.CER C1005 JB 1A 104K-T	B	53.4/78.0
C30	4030017460	S.CER C1005 JB 1H 102K-T	T	59.8/67.1
C31	4030016930	S.CER C1005 JB 1A 104K-T	T	60.6/53.1
C32	4030017590	S.CER C1005 CH 1H 070C-T	B	38.4/79.2
C33	4030016930	S.CER C1005 JB 1A 104K-T	T	58.9/67.1
C34	4030017570	S.CER C1005 CH 1H 040B-T	B	37.2/78.7
C35	4030016930	S.CER C1005 JB 1A 104K-T	B	35.8/75.7
C36	4030017500	S.CER C1005 CH 1H 560J-T	B	37.2/79.6
C37	4030016930	S.CER C1005 JB 1A 104K-T	B	48.5/79.8
C38	4030016930	S.CER C1005 JB 1A 104K-T	B	69.8/78.2
C39	4030017360	S.CER C1005 CH 1H 030B-T	B	71.4/77.3
C40	4030017690	S.CER C1005 CH 1H 121J-T	B	68.2/76.4
C41	4030018860	S.CER C1005 JB 0J 105K-T	B	31.1/58.3
C42	4030017690	S.CER C1005 CH 1H 121J-T	B	66.4/78.2
C43	4030016930	S.CER C1005 JB 1A 104K-T	B	55.6/49.0
C44	4030018860	S.CER C1005 JB 0J 105K-T	B	35.7/56.5
C45	4030016950	S.CER C1005 JB 1A 473K-T	B	34.5/55.2
C47	4030017460	S.CER C1005 JB 1H 102K-T	B	64.6/77.3
C48	4030016930	S.CER C1005 JB 1A 104K-T	T	54.3/54.4
C49	4030018860	S.CER C1005 JB 0J 105K-T	B	15.6/58.3
C50	4030016930	S.CER C1005 JB 1A 104K-T	B	130.8/48.4

[MAIN UNIT]

REF NO.	PARTS NO.	DESCRIPTION	M.	H/V LOCATION
C51	4030017620	S.CER C1005 CH 1H 100C-T	B	125.1/45.6
C52	4030017420	S.CER C1005 CH 1H 470J-T	B	120.6/48.8
C53	4030017420	S.CER C1005 CH 1H 470J-T	B	32.7/78.5
C54	4030017660	S.CER C1005 CH 1H 330J-T	B	32.7/77.3
C56	4030016950	S.CER C1005 JB 1A 473K-T	B	32.0/59.2
C59	4030017430	S.CER C1005 CH 1H 101J-T	B	32.7/75.5
C60	4030017620	S.CER C1005 CH 1H 100C-T	B	32.3/72.7
C61	4030018900	S.CER C1005 JB 0J 474K-T	B	18.1/63.9
C62	4030016930	S.CER C1005 JB 1A 104K-T	B	33.6/55.2
C63	4030016930	S.CER C1005 JB 1A 104K-T	T	55.6/62.1
C64	4030017460	S.CER C1005 JB 1H 102K-T	B	33.2/104.3
C66	4030017430	S.CER C1005 CH 1H 101J-T	B	123.5/48.4
C67	4030017460	S.CER C1005 JB 1H 102K-T	B	67.8/87.7
C69	4030016930	S.CER C1005 JB 1A 104K-T	B	29.8/63.0
C70	4030017460	S.CER C1005 JB 1H 102K-T	B	64.3/79.4
C71	4030016930	S.CER C1005 JB 1A 104K-T	B	57.6/43.3
C72	4030018910	S.CER C1608 JB 0J 475K-T	B	29.3/62.0
C73	4030017460	S.CER C1005 JB 1H 102K-T	B	93.7/46.2
C74	4030017780	S.CER C1005 JB 1H 472K-T	B	93.7/40.7
C75	4030017460	S.CER C1005 JB 1H 102K-T	B	39.6/106.1
C76	4030017780	S.CER C1005 JB 1H 472K-T	B	29.9/98.3
C77	4030016930	S.CER C1005 JB 1A 104K-T	T	53.9/57.7
C78	4030017460	S.CER C1005 JB 1H 102K-T	B	118.7/48.8
C79	4030017460	S.CER C1005 JB 1H 102K-T	B	34.3/79.5
C80	4030017380	S.CER C1005 CH 1H 050B-T	B	102.4/44.5
C81	4030017380	S.CER C1005 CH 1H 050B-T	B	44.0/101.1
C82	4550006250	S.TAN TEESVA 1A 106M8R	B	61.1/79.2
C83	4030017460	S.CER C1005 JB 1H 102K-T	B	71.8/86.8
C84	4030017420	S.CER C1005 CH 1H 470J-T	B	74.8/81.7
C85	4030017590	S.CER C1005 CH 1H 070C-T	B	56.0/43.3
C86	4030016930	S.CER C1005 JB 1A 104K-T	B	51.8/47.2
C87	4030018910	S.CER C1608 JB 0J 475K-T	B	54.3/48.4
C88	4030017780	S.CER C1005 JB 1H 472K-T	B	92.1/40.7
C89	4030017780	S.CER C1005 JB 1H 472K-T	B	28.3/99.3
C90	4030017680	S.CER C1005 CH 1H 820J-T	B	69.1/86.8
C91	4030016930	S.CER C1005 JB 1A 104K-T	T	60.7/66.3
C92	4030016790	S.CER C1005 JB 1E 103K-T	B	72.8/88.0
C93	4030017460	S.CER C1005 JB 1H 102K-T	B	70.5/87.2
C94	4030017350	S.CER C1005 CH 1H 020B-T	B	103.2/47.6
C96	4030018910	S.CER C1608 JB 0J 475K-T	B	49.2/48.9
C97	4030016930	S.CER C1005 JB 1A 104K-T	B	57.4/50.6
C98	4030017460	S.CER C1005 JB 1H 102K-T	B	36.4/105.2
C99	4030017460	S.CER C1005 JB 1H 102K-T	B	40.8/71.1
C100	4030017460	S.CER C1005 JB 1H 102K-T	B	84.7/48.0
C101	4030017620	S.CER C1005 CH 1H 100C-T	B	37.8/63.2
C102	4550007650	S.TAN F931V105MAABMA	B	88.7/41.0
C103	4550007650	S.TAN F931V105MAABMA	B	26.2/100.3
C104	4030016930	S.CER C1005 JB 1A 104K-T	B	39.9/74.3
C105	4030017580	S.CER C1005 CH 1H 060C-T	B	103.2/46.7
C106	4030017350	S.CER C1005 CH 1H 020B-T	B	47.0/102.2
C107	4030017590	S.CER C1005 CH 1H 070C-T	B	72.3/90.0
C108	4030017460	S.CER C1005 JB 1H 102K-T	B	87.1/48.0
C109	4030017380	S.CER C1005 CH 1H 050B-T	B	101.9/47.2
C110	4030017360	S.CER C1005 CH 1H 030B-T	B	46.5/103.5
C111	4030016790	S.CER C1005 JB 1E 103K-T	B	71.0/93.8
C112	4550007650	S.TAN F931V105MAABMA	B	83.6/41.0
C113	4550007650	S.TAN F931V105MAABMA	B	28.3/105.6
C114	4030017580	S.CER C1005 CH 1H 060C-T	B	103.2/48.5
C115	4030017350	S.CER C1005 CH 1H 020B-T	B	47.0/104.9
C116	4030017460	S.CER C1005 JB 1H 102K-T	B	71.0/91.0
C117	4030016790	S.CER C1005 JB 1E 103K-T	B	73.5/95.7
C118	4030016790	S.CER C1005 JB 1E 103K-T	B	71.0/92.0
C119	4030017350	S.CER C1005 CH 1H 020B-T	B	103.2/49.4
C121	4030016790	S.CER C1005 JB 1E 103K-T	B	71.0/94.8
C122	4030016790	S.CER C1005 JB 1E 103K-T	B	69.1/90.1
C123	4030016930	S.CER C1005 JB 1A 104K-T	B	67.4/98.3
C124	4030016930	S.CER C1005 JB 1A 104K-T	B	48.5/50.5
C125	4030016790	S.CER C1005 JB 1E 103K-T	B	98.1/42.6
C126	4030016790	S.CER C1005 JB 1E 103K-T	B	57.2/35.1
C127	4030016790	S.CER C1005 JB 1E 103K-T	T	32.4/108.3
C133	4030017590	S.CER C1005 CH 1H 070C-T	B	59.6/92.0
C134	4550000550	S.TAN TEESVA 1V 224M8R	B	26.2/105.6
C135	4030016930	S.CER C1005 JB 1A 104K-T	B	30.8/110.6
C136	4030016930	S.CER C1005 JB 1A 104K-T	B	50.4/36.9
C137	4030017620	S.CER C1005 CH 1H 100C-T	B	56.2/38.3
C138	4030017640	S.CER C1005 CH 1H 15		

[MAIN UNIT]

REF NO.	PARTS NO.	DESCRIPTION	M.	H/V LOCATION
C171	4030017400	S.CER C1005 CH 1H 220J-T	B	28.7/113.7
C172	4030017510	S.CER C1005 CH 1H 680J-T	B	85.8/63.9
C173	4030017550	S.CER C1005 CH 1H 1R5B-T	B	93.0/66.4
C174	4030017420	S.CER C1005 CH 1H 470J-T	B	84.4/54.1
C175	4030017460	S.CER C1005 JB 1H 102K-T	T	93.1/53.9
C176	4030018860	S.CER C1005 JB 0J 105K-T	B	90.9/57.7
C177	4030017600	S.CER C1005 CH 1H 080C-T	B	36.7/123.3
C178	4030017600	S.CER C1005 CH 1H 080C-T	B	37.6/111.1
C179	4030017420	S.CER C1005 CH 1H 470J-T	T	14.9/129.1
C180	4030017640	S.CER C1005 CH 1H 150J-T	B	91.7/65.0
C181	4030018070	S.CER C1005 CH 1H 300J-T	B	83.4/54.1
C182	4030016790	S.CER C1005 JB 1E 103K-T	B	63.1/104.4
C183	4030017420	S.CER C1005 CH 1H 470J-T	T	14.9/131.3
C184	4030017670	S.CER C1005 CH 1H 390J-T	B	37.9/124.9
C185	4030018010	S.CER C1005 CH 1H 360J-T	B	37.6/115.6
C186	4030017420	S.CER C1005 CH 1H 470J-T	T	93.1/57.7
C187	4030017420	S.CER C1005 CH 1H 470J-T	T	95.3/67.6
C188	4030017650	S.CER C1005 CH 1H 270J-T	B	84.9/63.9
C189	4030017620	S.CER C1005 CH 1H 100C-T	B	93.1/51.4
C190	4030017550	S.CER C1005 CH 1H 1R5B-T	B	93.1/56.8
C191	4030017660	S.CER C1005 CH 1H 330J-T	B	93.0/65.5
C192	4030017670	S.CER C1005 CH 1H 390J-T	B	93.1/55.9
C193	4030017460	S.CER C1005 JB 1H 102K-T	B	61.4/107.1
C194	4030017660	S.CER C1005 CH 1H 330J-T	B	37.9/123.1
C195	4030017670	S.CER C1005 CH 1H 390J-T	B	40.3/120.7
C196	4030018010	S.CER C1005 CH 1H 360J-T	B	37.6/113.8
C197	4030017670	S.CER C1005 CH 1H 390J-T	B	41.7/112.2
C198	4030016790	S.CER C1005 JB 1E 103K-T	B	60.5/107.1
C199	4030017460	S.CER C1005 JB 1H 102K-T	T	95.3/63.1
C200	4030017650	S.CER C1005 CH 1H 270J-T	B	93.0/63.7
C201	4030017660	S.CER C1005 CH 1H 330J-T	B	96.0/62.0
C202	4030017670	S.CER C1005 CH 1H 390J-T	B	93.1/54.1
C203	4030017420	S.CER C1005 CH 1H 470J-T	B	97.2/52.0
C204	4550006250	S.TAN TEESVA 1A 106M8R	T	81.6/117.0
C205	4550006250	S.TAN TEESVA 1A 106M8R	T	85.1/117.0
C206	4550006250	S.TAN TEESVA 1A 106M8R	T	88.5/117.0
C208	4030018860	S.CER C1005 JB 0J 105K-T	T	80.0/17.0
C209	4030018860	S.CER C1005 JB 0J 105K-T	T	83.5/17.0
C210	4030018860	S.CER C1005 JB 0J 105K-T	T	86.9/17.0
C211	4030016930	S.CER C1005 JB 1A 104K-T	B	38.5/120.7
C212	4030016790	S.CER C1005 JB 1E 103K-T	B	39.9/112.2
C213	4030017650	S.CER C1005 CH 1H 270J-T	B	68.5/106.1
C214	4030017460	S.CER C1005 JB 1H 102K-T	B	66.8/107.0
C215	4030017540	S.CER C1005 CH 1H R75B-T	B	42.8/118.5
C216	4030017540	S.CER C1005 CH 1H R75B-T	B	42.8/116.9
C217	4030017460	S.CER C1005 JB 1H 102K-T	B	39.4/120.7
C218	4030017460	S.CER C1005 JB 1H 102K-T	B	40.8/112.2
C219	4030016790	S.CER C1005 JB 1E 103K-T	B	94.2/62.0
C220	4030017530	S.CER C1005 CH 1H 0R5B-T	B	98.5/59.6
C221	4030016790	S.CER C1005 JB 1E 103K-T	B	95.4/52.0
C222	4030017530	S.CER C1005 CH 1H 0R5B-T	B	99.4/56.6
C224	4030017460	S.CER C1005 JB 1H 102K-T	B	95.1/62.0
C225	4030017460	S.CER C1005 JB 1H 102K-T	B	96.3/52.0
C228	4030018860	S.CER C1005 JB 0J 105K-T	T	78.6/24.6
C229	4030018860	S.CER C1005 JB 0J 105K-T	T	83.2/24.9
C230	4030018860	S.CER C1005 JB 0J 105K-T	T	86.8/24.0
C231	4550005980	S.TAN TEESVA 1A 475M8R	T	80.3/25.8
C232	4550005980	S.TAN TEESVA 1A 475M8R	T	84.8/26.2
C233	4550005980	S.TAN TEESVA 1A 475M8R	T	88.5/25.7
C235	4030017030	S.CER C1005 JB 1A 273K-T	T	41.0/55.0
C236	4030017730	S.CER C1005 JB 1H 471K-T	B	100.6/55.0
C237	4030017460	S.CER C1005 JB 1H 102K-T	B	100.6/60.4
C238	4030017730	S.CER C1005 JB 1H 471K-T	B	44.9/113.8
C239	4030017460	S.CER C1005 JB 1H 102K-T	B	44.9/119.2
C240	4510009550	S.ELE EEEFK1C100R	T	95.1/22.4
C241	4030017350	S.CER C1005 CH 1H 020B-T	B	68.3/120.9
C242	4030016790	S.CER C1005 JB 1E 103K-T	B	68.7/111.2
C243	4030017460	S.CER C1005 JB 1H 102K-T	B	70.3/106.1
C244	4030016790	S.CER C1005 JB 1E 103K-T	B	70.3/107.0
C245	4030017460	S.CER C1005 JB 1H 102K-T	T	94.8/60.2
C246	4030017620	S.CER C1005 CH 1H 100C-T	B	46.9/114.7
C247	4030017460	S.CER C1005 JB 1H 102K-T	B	42.6/112.2
C248	4030017460	S.CER C1005 JB 1H 102K-T	B	36.0/117.8
C249	4030017420	S.CER C1005 CH 1H 470J-T	B	48.0/112.2
C250	4030017590	S.CER C1005 CH 1H 070C-T	B	103.7/58.7
C251	4030017620	S.CER C1005 CH 1H 100C-T	B	102.6/55.9
C252	4030017460	S.CER C1005 JB 1H 102K-T	B	99.2/51.3
C253	4030017590	S.CER C1005 CH 1H 070C-T	B	48.0/117.4
C254	4030017460	S.CER C1005 JB 1H 102K-T	B	103.7/53.0
C255	4030016930	S.CER C1005 JB 1A 104K-T	T	42.1/50.6
C256	4030017640	S.CER C1005 CH 1H 150J-T	T	43.1/55.0
C257	4030016790	S.CER C1005 JB 1E 103K-T	T	36.5/58.8
C258	4030017390	S.CER C1005 CH 1H 180J-T	B	59.6/117.8
C259	4030017580	S.CER C1005 CH 1H 060C-T	T	48.5/46.4
C260	4030017460	S.CER C1005 JB 1H 102K-T	B	46.5/107.5
C261	4030017460	S.CER C1005 JB 1H 102K-T	B	47.7/110.3
C262	4030016930	S.CER C1005 JB 1A 104K-T	T	69.2/57.5
C263	4030017460	S.CER C1005 JB 1H 102K-T	B	60.5/126.1
C264	4030017460	S.CER C1005 JB 1H 102K-T	B	101.9/48.9
C265	4030017460	S.CER C1005 JB 1H 102K-T	B	43.5/120.7
C266	4030018900	S.CER C1005 JB 0J 474K-T	T	43.7/45.6
C267	4030017660	S.CER C1005 CH 1H 330J-T	B	59.6/119.3
C268	4030017460	S.CER C1005 JB 1H 102K-T	B	62.3/126.1
C269	4550006780	S.TAN TEESVB2 0J 476M8R	T	72.2/60.8
C270	4030016930	S.CER C1005 JB 1A 104K-T	T	40.5/49.7
C271	4030017610	S.CER C1005 CH 1H 090C-T	B	70.7/137.8
C272	4030017630	S.CER C1005 CH 1H 120J-T	T	47.4/60.1
C274	4030017460	S.CER C1005 JB 1H 102K-T	B	44.4/120.7
C275	4030017620	S.CER C1005 CH 1H 100C-T	B	48.0/124.4
C276	4030017600	S.CER C1005 CH 1H 080C-T	B	71.9/139.9
C277	4030016790	S.CER C1005 JB 1E 103K-T	T	48.7/36.8
C279	4030017390	S.CER C1005 CH 1H 180J-T	B	59.6/120.9
C280	4030017460	S.CER C1005 JB 1H 102K-T	B	98.9/66.3
C281	4030017460	S.CER C1005 JB 1H 102K-T	B	100.0/62.0
C282	4030017630	S.CER C1005 CH 1H 120J-T	B	61.4/122.2

[MAIN UNIT]

REF NO.	PARTS NO.	DESCRIPTION	M.	H/V LOCATION
C283	4030017620	S.CER C1005 CH 1H 100C-T	B	103.7/65.9
C286	4030017570	S.CER C1005 CH 1H 040B-T	B	61.4/140.3
C287	4030017350	S.CER C1005 CH 1H 020B-T	B	58.2/138.5
C288	4030017570	S.CER C1005 CH 1H 040B-T	B	64.1/139.8
C289	4030017600	S.CER C1005 CH 1H 080C-T	B	71.9/135.7
C290	4030017600	S.CER C1005 CH 1H 080C-T	B	70.7/139.5
C291	4030017340	S.CER C1005 CH 1H 010B-T	B	102.4/66.6
C292	4030017460	S.CER C1005 JB 1H 102K-T	B	61.4/136.7
C293	4030017570	S.CER C1005 CH 1H 040B-T	B	44.0/100.2
C294	4030017360	S.CER C1005 CH 1H 030B-T	B	47.7/108.1
C295	4030017460	S.CER C1005 JB 1H 102K-T	B	61.4/135.8
C296	4030019420	S.CER GRM31A7U2J102JW31D	B	98.7/132.7
C297	4030017580	S.CER C1005 CH 1H 060C-T	B	88.8/138.9
C298	4030017460	S.CER C1005 JB 1H 102K-T	B	132.9/86.7
C299	4030017460	S.CER C1005 JB 1H 102K-T	B	58.2/137.6
C300	4030017460	S.CER C1005 JB 1H 102K-T	B	58.2/134.9
C301	4030016790	S.CER C1005 JB 1E 103K-T	B	58.2/136.7
C302	4030017460	S.CER C1005 JB 1H 102K-T	B	54.2/139.8
C303	4030017400	S.CER C1005 CH 1H 220J-T	B	131.1/82.4
C304	4030017420	S.CER C1005 CH 1H 470J-T	B	133.8/86.7
C305	4030017420	S.CER C1005 CH 1H 470J-T	B	47.4/134.3
C306	4030017460	S.CER C1005 JB 1H 102K-T	B	48.4/134.3
C307	4030017460	S.CER C1005 JB 1H 102K-T	B	46.5/138.8
C309	4030016790	S.CER C1005 JB 1E 103K-T	B	134.7/88.4
C310	4030017630	S.CER C1005 CH 1H 120J-T	B	136.5/86.7
C311	4030016930	S.CER C1005 JB 1A 104K-T	B	46.5/140.4
C312	4030016930	S.CER C1005 JB 1A 104K-T	B	51.4/142.5
C313	4030016930	S.CER C1005 JB 1A 104K-T	B	47.4/140.4
C314	4030017460	S.CER C1005 JB 1H 102K-T	B	50.4/142.5
C315	4030017730	S.CER C1005 JB 1H 471K-T	B	136.5/92.3
C318	4030017460	S.CER C1005 JB 1H 102K-T	T	117.8/106.3
C319	4030017460	S.CER C1005 JB 1H 102K-T	T	117.8/105.4
C320	4030017460	S.CER C1005 JB 1H 102K-T	T	115.2/106.3
C321	4030017420	S.CER C1005 CH 1H 470J-T	T	66.0/57.5
C322	4030017420	S.CER C1005 CH 1H 470J-T	T	62.3/52.0
C323	4030017350	S.CER C1005 CH 1H 020B-T	B	45.6/138.8
C324	4030017630	S.CER C1005 CH 1H 120J-T	B	135.6/83.3
C325	4030017460	S.CER C1005 JB 1H 102K-T	B	134.7/90.1
C327	4030017640	S.CER C1005 CH 1H 150J-T	B	142.8/85.0
C328	4030017420	S.CER C1005 CH 1H 470J-T	B	137.8/92.3
C329	4030017640	S.CER C1005 CH 1H 150J-T	B	36.0/142.3
C330	4030017460	S.CER C1005 JB 1H 102K-T	B	138.9/92.3
C331	4030017460	S.CER C1005 JB 1H 102K-T	B	60.4/142.5
C332	4030017460	S.CER C1005 JB 1H 102K-T	B	56.0/142.5
C333	4030016930	S.CER C1005 JB 1A 104K-T	T	23.1/29.4
C334	4510009810	S.ELE EEEFK1E220R	T	137.5/89.8
C335	4030017390	S.CER C1005 CH 1H 180J-T	B	144.3/89.3
C336	4030017420	S.CER C1005 CH 1H 470J-T	B	61.3/142.5
C337	4030017400	S.CER C1005 CH 1H 220J-T	B	144.3/88.2
C338	4030017460	S.CER C1005 JB 1H 102K-T	B	36.0/139.2
C339	4030017460	S.CER C1005 JB 1H 102K-T	B	36.0/135.7
C340	4030016930	S.CER C1005 JB 1A 104K-T	T	54.0/20.4
C341	4030017420	S.CER C1005 CH 1H 470J-T	B	132.9/90.1
C342	4030017730	S.CER C1005 JB 1H 471K-T	T	138.8/108.0
C343	4550002890	S.TAN TEESVA 1A 225M8R	T	148.3/126.0
C345	4030017460	S.CER C1005 JB 1H 102K-T	B	36.0/134.8
C346	4030017420	S.CER C1005 CH 1H 470J-T	T	63.2/56.9
C347	4030017460	S.CER C1005 JB 1H 102K-T	T	145.0/127.7
C348	4030017420	S.CER C1005 CH 1H 470J-T	B	64.2/55.5
C349	4030017400	S.CER C1005 CH 1H 220J-T	B	144.2/91.0
C350	4030017420	S.CER C1005 CH 1H 470J-T	T	138.7/112.3
C351	4030017460	S.CER C1005 JB 1H 102K-T	T	138.7/113.2
C353	4030017460	S.CER C1005 JB 1H 102K-T	T	140.4/127.7
C354	4030017420	S.CER C1005 CH 1H 470J-T	T	113.0/117.0
C355	4030017340	S.CER C1005 CH 1H 010B-T	B	34.4/134.0
C357	4030017640	S.CER C1005 CH 1H 150J-T	B	36.0/140.7
C358	4030016790	S.CER C1005 JB 1E 103K-T	T	142.2/127.7
C359	4510009550	S.ELE EEEFK1C100R	T	105.3/87.6
C360	4030017460	S.CER C1005 JB 1H 102		

[MAIN UNIT]

REF NO.	PARTS NO.	DESCRIPTION	M.	H/V LOCATION
C401	4030011170	S.CER GRM31M2C2H180JV01L (GRM42-6 CH)	B	103.4/131.2
C402	4030016930	S.CER C1005 JB 1A 104K-T	T	47.2/71.6
C404	4030017460	S.CER C1005 JB 1H 102K-T	T	143.1/127.7
C405	4030017420	S.CER C1005 CH 1H 470J-T	B	57.6/56.9
C406	4030016790	S.CER C1005 JB 1E 103K-T	T	103.5/76.2
C408	4030017460	S.CER C1005 JB 1H 102K-T	B	85.6/127.6
C409	4030011170	S.CER GRM31M2C2H180JV01L (GRM42-6 CH)	B	112.4/131.2
C410	4030011170	S.CER GRM31M2C2H180JV01L (GRM42-6 CH)	B	114.6/131.2
C411	4550007650	S.TAN F931V105MAABMA	T	37.6/68.6
C412	4030017460	S.CER C1005 JB 1H 102K-T	T	104.5/77.8
C413	4030016930	S.CER C1005 JB 1A 104K-T	T	38.5/71.9
C414	4030017420	S.CER C1005 CH 1H 470J-T	B	37.6/134.0
C415	4550007650	S.TAN F931V105MAABMA	T	37.6/63.4
C416	4550006250	S.TAN TEESVA 1A 106M8R	T	106.9/81.6
C417	4030016930	S.CER C1005 JB 1A 104K-T	T	15.0/125.8
C418	4550007650	S.TAN F931V105MAABMA	T	39.5/74.0
C419	4030011170	S.CER GRM31M2C2H180JV01L (GRM42-6 CH)	B	117.3/131.2
C420	4030016930	S.CER C1005 JB 1A 104K-T	B	27.4/18.5
C421	4030017460	S.CER C1005 JB 1H 102K-T	B	86.5/127.6
C422	4030017730	S.CER C1005 JB 1H 471K-T	B	119.6/139.5
C423	4030017460	S.CER C1005 JB 1H 102K-T	B	121.5/145.1
C424	4030016930	S.CER C1005 JB 1A 104K-T	T	14.1/125.8
C426	4030017640	S.CER C1005 CH 1H 150J-T	B	120.9/139.5
C428	4030017390	S.CER C1005 CH 1H 180J-T	B	144.3/86.6
C429	4030017460	S.CER C1005 JB 1H 102K-T	B	122.4/143.4
C431	4030018860	S.CER C1005 JB 0J 105K-T	B	33.3/13.6
C432	4030016930	S.CER C1005 JB 1A 104K-T	T	10.8/120.7
C433	4030017730	S.CER C1005 JB 1H 471K-T	B	139.5/138.1
C434	4030017460	S.CER C1005 JB 1H 102K-T	B	137.7/133.5
C435	4030017460	S.CER C1005 JB 1H 102K-T	T	54.9/29.9
C436	4030011170	S.CER GRM31M2C2H180JV01L (GRM42-6 CH)	B	143.7/137.0
C437	4030016930	S.CER C1005 JB 1A 104K-T	B	34.4/12.0
C438	4030016790	S.CER C1005 JB 1E 103K-T	T	109.7/89.0
C439	4510009810	S.ELE EEEFK1E220R	T	129.9/96.8
C440	4030018900	S.CER C1005 JB 0J 474K-T	T	8.0/129.6
C441	4030017440	S.CER C1005 CH 1H 221J-T	T	12.0/126.2
C442	4510009680	S.ELE EEEFK1E471P	B	9.6/119.8
C443	4030017460	S.CER C1005 JB 1H 102K-T	T	108.8/89.0
C444	4030011170	S.CER GRM31M2C2H180JV01L (GRM42-6 CH)	B	147.0/149.0
C445	4030017600	S.CER C1005 CH 1H 080C-T	B	26.1/141.0
C446	4030017460	S.CER C1005 JB 1H 102K-T	T	6.7/130.1
C448	4030017460	S.CER C1005 JB 1H 102K-T	T	126.9/103.4
C449	4510008870	S.ELE EEE1AA471UP	B	8.9/139.2
C450	4030019090	S.CER C2012 JB 1C 225M-T	T	7.5/125.1
C451	4030018860	S.CER C1005 JB 0J 105K-T	T	9.7/125.5
C452	4030018860	S.CER C1005 JB 0J 105K-T	T	71.5/98.2
C453	4030017460	S.CER C1005 JB 1H 102K-T	T	127.9/103.4
C454	4030017430	S.CER C1005 CH 1H 101J-T	B	46.3/56.9
C458	4030017460	S.CER C1005 JB 1H 102K-T	T	129.6/113.3
C459	4030017460	S.CER C1005 JB 1H 102K-T	T	117.8/117.7
C460	4030017460	S.CER C1005 JB 1H 102K-T	B	9.7/147.4
C461	4030017420	S.CER C1005 CH 1H 470J-T	T	130.5/113.3
C462	4030017420	S.CER C1005 CH 1H 470J-T	T	117.8/116.7
C463	4030017420	S.CER C1005 CH 1H 470J-T	B	9.7/146.5
C464	4510009680	S.ELE EEEFK1E471P	B	144.4/121.1
C465	4550006250	S.TAN TEESVA 1A 106M8R	T	96.1/87.8
C466	4030017420	S.CER C1005 CH 1H 470J-T	T	99.9/88.1
C467	4030016930	S.CER C1005 JB 1A 104K-T	T	62.3/58.5
C468	4030016930	S.CER C1005 JB 1A 104K-T	T	61.8/56.9
C469	4030017460	S.CER C1005 JB 1H 102K-T	B	141.3/90.1
C470	4030018860	S.CER C1005 JB 0J 105K-T	T	7.5/122.3
C471	4030016790	S.CER C1005 JB 1E 103K-T	T	6.2/123.6
C472	4030018860	S.CER C1005 JB 0J 105K-T	T	11.0/117.8
C473	4030018860	S.CER C1005 JB 0J 105K-T	T	5.1/118.9
C474	4030017780	S.CER C1005 JB 1H 472K-T	T	115.3/17.6
C475	4510008120	S.ELE 16 CE 100 BS	T	125.1/12.1
C476	4510008120	S.ELE 16 CE 100 BS	T	125.1/19.3
C477	4030017780	S.CER C1005 JB 1H 472K-T	T	118.9/12.2
C478	4030017780	S.CER C1005 JB 1H 472K-T	T	115.3/12.2
C479	4510008120	S.ELE 16 CE 100 BS	T	104.8/14.3
C481	4030017460	S.CER C1005 JB 1H 102K-T	B	63.2/122.2
C491	4030016930	S.CER C1005 JB 1A 104K-T	T	60.4/60.1
C492	4030016930	S.CER C1005 JB 1A 104K-T	B	13.5/32.6
C493	4510008870	S.ELE EEE1AA471UP	B	66.3/45.3
C494	4030017330	S.CER C1005 JB 1C 104Z-T	T	101.5/92.4
C495	4030016930	S.CER C1005 JB 1A 104K-T	T	101.5/90.1
C496	4030017330	S.CER C1005 JB 1C 104Z-T	T	123.3/92.9
C497	4030016930	S.CER C1005 JB 1A 104K-T	T	109.9/81.2
C498	4030016930	S.CER C1005 JB 1A 104K-T	T	11.5/43.3
C501	4030017420	S.CER C1005 CH 1H 470J-T	T	11.7/31.2
C502	4030017460	S.CER C1005 JB 1H 102K-T	T	29.5/2.8
C503	4030017420	S.CER C1005 CH 1H 470J-T	T	48.0/99.4
C506	4030016930	S.CER C1005 JB 1A 104K-T	B	26.3/43.4
C507	4030016930	S.CER C1005 JB 1A 104K-T	B	32.9/31.0
C508	4030016930	S.CER C1005 JB 1A 104K-T	B	40.2/42.7
C509	4030016930	S.CER C1005 JB 1A 104K-T	B	26.3/39.1
C510	4030016930	S.CER C1005 JB 1A 104K-T	B	26.6/33.0
C511	4030016930	S.CER C1005 JB 1A 104K-T	B	40.1/34.2
C512	4030017420	S.CER C1005 CH 1H 470J-T	T	92.1/14.8
C513	4550006250	S.TAN TEESVA 1A 106M8R	B	8.4/59.8
C514	4030016930	S.CER C1005 JB 1A 104K-T	B	11.7/53.5
C515	4030016930	S.CER C1005 JB 1A 104K-T	B	15.6/54.5
C516	4030016930	S.CER C1005 JB 1A 104K-T	B	65.1/69.6
C517	4030016930	S.CER C1005 JB 1A 104K-T	B	15.6/63.1
C518	4030016930	S.CER C1005 JB 1A 104K-T	B	12.5/62.5
C519	4030017460	S.CER C1005 JB 1H 102K-T	B	15.6/59.9
C521	4030016930	S.CER C1005 JB 1A 104K-T	B	18.1/53.6
C522	4030016930	S.CER C1005 JB 1A 104K-T	T	51.2/31.8
C523	4030016930	S.CER C1005 JB 1A 104K-T	T	51.2/33.0

[MAIN UNIT]

REF NO.	PARTS NO.	DESCRIPTION	M.	H/V LOCATION
C524	4030018910	S.CER C1608 JB 0J 475K-T	T	9.5/56.0
C525	4030018910	S.CER C1608 JB 0J 475K-T	B	25.8/58.3
C526	4030017730	S.CER C1005 JB 1H 471K-T	B	29.9/58.0
C527	4030016790	S.CER C1005 JB 1E 103K-T	B	26.1/50.3
C528	4030017670	S.CER C1005 CH 1H 390J-T	B	37.6/120.7
C529	4030017630	S.CER C1005 CH 1H 120J-T	B	39.0/112.2
C530	4030017420	S.CER C1005 CH 1H 470J-T	T	58.7/62.6
C531	4030017670	S.CER C1005 CH 1H 390J-T	B	93.0/61.9
C532	4030017670	S.CER C1005 CH 1H 390J-T	B	94.5/52.0
C533	4510008120	S.ELE 16 CE 100 BS	T	125.1/26.4
C534	4030016790	S.CER C1005 JB 1E 103K-T	T	118.4/26.7
C535	4030016790	S.CER C1005 JB 1E 103K-T	B	66.4/102.5
C536	4030016790	S.CER C1005 JB 1E 103K-T	B	64.8/99.1
C538	4030006860	S.CER C1608 JB 1H 102K-T	T	36.3/145.1
C539	4030017790	S.CER C1005 JB 1H 682K-T	T	22.8/57.0
C540	4030017730	S.CER C1005 JB 1H 471K-T	T	21.2/56.6
C541	4030016930	S.CER C1005 JB 1A 104K-T	T	22.8/55.4
C542	4030017440	S.CER C1005 CH 1H 221J-T	T	27.1/55.0
C543	4030016930	S.CER C1005 JB 1A 104K-T	T	56.3/68.9
C544	4030017460	S.CER C1005 JB 1H 102K-T	T	62.4/72.9
C545	4030011100	S.CER GRM31M2C2H8R0DV01L (GRM42-6 CH)	T	97.6/106.8
C546	4030018910	S.CER C1608 JB 0J 475K-T	B	40.4/56.7
C547	4030017760	S.CER C1005 JB 1H 222K-T	T	53.7/72.1
C548	4030016930	S.CER C1005 JB 1A 104K-T	T	14.1/120.6
C549	4030017420	S.CER C1005 CH 1H 470J-T	T	122.0/85.7
C550	4030017420	S.CER C1005 CH 1H 470J-T	T	71.5/85.1
C551	4030017330	S.CER C1005 JB 1C 104Z-T	T	114.1/28.1
C552	4030016790	S.CER C1005 JB 1E 103K-T	B	121.9/48.8
C553	4030016930	S.CER C1005 JB 1A 104K-T	B	30.8/19.4
C555	4030016930	S.CER C1005 JB 1A 104K-T	B	69.8/75.5
C556	4030017330	S.CER C1005 JB 1C 104Z-T	T	105.2/28.6
C557	4030016930	S.CER C1005 JB 1A 104K-T	T	97.0/28.6
C558	4550006250	S.TAN TEESVA 1A 106M8R	T	95.1/27.9
C559	4550007080	S.TAN TEESVA 1C 106M8R	T	45.9/75.5
C562	4030017420	S.CER C1005 CH 1H 470J-T	T	34.7/79.6
C563	4030016930	S.CER C1005 JB 1A 104K-T	B	25.6/122.0
C566	4030018860	S.CER C1005 JB 0J 105K-T	B	39.0/72.7
C568	4030018100	S.CER C1005 JB 1H 681K-T	T	89.8/58.8
C570	4030017460	S.CER C1005 JB 1H 102K-T	B	70.7/136.1
C571	4030017580	S.CER C1005 CH 1H 060C-T	T	64.0/99.1
C572	4030017580	S.CER C1005 CH 1H 060C-T	T	64.9/99.1
C573	4030017580	S.CER C1005 CH 1H 060C-T	T	64.7/97.8
C574	4030017580	S.CER C1005 CH 1H 060C-T	B	61.4/134.9
C575	4030017420	S.CER C1005 CH 1H 470J-T	B	61.4/134.0
C576	4030017460	S.CER C1005 JB 1H 102K-T	T	67.3/105.8
C577	4030017460	S.CER C1005 JB 1H 102K-T	T	67.3/104.9
C578	4030019420	S.CER GRM31A7U2J102JW31D	T	90.8/126.0
C579	4550006250	S.TAN TEESVA 1A 106M8R	B	98.3/46.9
C580	4030017420	S.CER C1005 CH 1H 470J-T	T	100.7/73.5
C581	4030018910	S.CER C1608 JB 0J 475K-T	B	46.3/60.9
C582	4030018910	S.CER C1608 JB 0J 475K-T	B	65.2/61.3
C583	4030016930	S.CER C1005 JB 1A 104K-T	B	46.3/58.6
C584	4030016790	S.CER C1005 JB 1E 103K-T	B	56.7/55.3
C585	4030016930	S.CER C1005 JB 1A 104K-T	B	54.9/58.6
C586	4030017730	S.CER C1005 JB 1H 471K-T	B	54.9/56.9
C587	4030016790	S.CER C1005 JB 1E 103K-T	B	52.3/59.8
C588	4030018910	S.CER C1608 JB 0J 475K-T	B	65.2/62.5
C589	4030017360	S.CER C1005 CH 1H 030B-T	B	103.2/51.6
C590	4030017570	S.CER C1005 CH 1H 040B-T	B	102.4/43.5
C610	4030018080	S.CER C1005 JB 1H 182K-T	T	29.7/12.8
C612	4030017460	S.CER C1005 JB 1H 102K-T	T	32.45/12.8
C614	4030017730	S.CER C1005 JB 1H 471K-T	T	35.2/14.1
C616	4030017460	S.CER C1005 JB 1H 102K-T	B	35.2/15.6
C617	4030017420	S.CER C1005 CH 1H 470J-T	T	67.3/13.6
C618	4030017420	S.CER C1005 CH 1H 470J-T	T	39.3/12.2
C619	4030017420	S.CER C1005 CH 1H 470J-T	T	39.3/13.4
C620	4030017420	S.CER C1005 CH 1H 470J-T	T	41.3/12.6
C621	4030017420	S.CER C1005 CH 1H 470J-T	T	27.4/13.9
C622	4030018910	S.CER C1608 JB 0J 475K-T	T	64.3/73.2
C623	4030017330	S.CER C1005 JB 1C 104Z-T	B	126.8/16.0
C624	4030017330	S.CER C1005 JB 1C 104Z-T	B	126.3/20.3
C625	4030017460	S.CER C1005 JB 1H 102K-T	B	126.8/17.2
C626	4510009810	S.ELE EEEFK1E220R	B	129.4/23.0
C629	4030016790	S.CER C1005 JB 1E 103K-T	B	113.2/27.1
C630	4030016930	S.CER C1005 JB 1A 104K-T	B	108.8/27.1

[MAIN UNIT]

REF NO.	PARTS NO.	DESCRIPTION	M.	H/V LOCATION
W2	7030012290	JUM RDS2T0R0		
W4	8900017520	CAB OPC-1783		
EP1	6910015370	S.BEA ACZ1005Y-102-T	B	129.1/48.4
EP2	6910015370	S.BEA ACZ1005Y-102-T	B	115.5/45.6
EP3	6910015370	S.BEA ACZ1005Y-102-T	B	32.4/81.6
EP4	6910016330	S.BEA MMZ1005S 601CT-S	B	30.5/60.6
EP5	6910015370	S.BEA ACZ1005Y-102-T	B	39.0/74.3
EP6	6910015370	S.BEA ACZ1005Y-102-T	T	38.5/108.3
EP7	6910016330	S.BEA MMZ1005S 601CT-S	B	40.7/36.7
EP8	6910015370	S.BEA ACZ1005Y-102-T	B	95.4/49.0
EP9	6910016330	S.BEA MMZ1005S 601CT-S	T	48.9/39.4
EP10	6910011560	BEA HF70BB4.5X5X1.6		
EP13	6910011330	TER OT-009 M3		
EP14	6910011330	TER OT-009 M3		
EP16	6910018460	S.BEA MMZ1005Y102C-T	T	64.1/105.0
EP17	6910018460	S.BEA MMZ1005Y102C-T	T	65.1/105.0
EP18	6910018460	S.BEA MMZ1005Y102C-T	T	66.1/105.0
EP19	6910018460	S.BEA MMZ1005Y102C-T	T	66.1/106.8
EP20	6910018460	S.BEA MMZ1005Y102C-T	T	62.8/98.7
EP21	6910018460	S.BEA MMZ1005Y102C-T	T	62.8/99.6
EP22	6910018460	S.BEA MMZ1005Y102C-T	T	74.1/105.0
EP23	6910018460	S.BEA MMZ1005Y102C-T	T	73.2/105.0
EP24	6910018460	S.BEA MMZ1005Y102C-T	T	72.3/105.0
EP25	6910018460	S.BEA MMZ1005Y102C-T	T	71.1/105.0
EP26	6910018460	S.BEA MMZ1005Y102C-T	T	72.4/99.0
EP27	6910018460	S.BEA MMZ1005Y102C-T	T	68.2/99.1
EP28	6910018460	S.BEA MMZ1005Y102C-T	T	67.3/99.1
EP29	6910018460	S.BEA MMZ1005Y102C-T	T	65.8/99.1
EP30	6910018460	S.BEA MMZ1005Y102C-T	T	74.3/99.0
EP31	6910018460	S.BEA MMZ1005Y102C-T	T	70.6/98.2

[CONNECT UNIT]

REF NO.	PARTS NO.	DESCRIPTION	M.	H/V LOCATION
C601	4030017420	S.CER C1005 CH 1H 470J-T	T	97.6/111.3
C602	4030017400	S.CER C1005 CH 1H 220J-T	T	12.2/12.4
C603	4030017420	S.CER C1005 CH 1H 470J-T	T	16.6/12.4
C604	4030017400	S.CER C1005 CH 1H 220J-T	T	15.0/14.2
C605	4030017420	S.CER C1005 CH 1H 470J-T	T	17.8/13.9
C606	4030017420	S.CER C1005 CH 1H 470J-T	T	19.4/12.4
C607	4030017420	S.CER C1005 CH 1H 470J-T	T	20.6/13.9
C608	4030017420	S.CER C1005 CH 1H 470J-T	T	22.7/12.4
C609	4030017420	S.CER C1005 CH 1H 470J-T	T	25.5/12.4
C610	4030017420	S.CER C1005 CH 1H 470J-T	T	63.3/69.6
C611	4030017420	S.CER C1005 CH 1H 470J-T	T	31.0/14.1
C612	4030017420	S.CER C1005 CH 1H 470J-T	B	55.7/29.9
C613	4030017420	S.CER C1005 CH 1H 470J-T	T	33.6/14.1
C614	4030017420	S.CER C1005 CH 1H 470J-T	B	29.0/13.2
C615	4030017420	S.CER C1005 CH 1H 470J-T	T	35.8/12.8
C616	4030017420	S.CER C1005 CH 1H 470J-T	T	95.3/62.2
C617	4030017420	S.CER C1005 CH 1H 470J-T	T	59.8/65.0
C618	4030017420	S.CER C1005 CH 1H 470J-T	T	64.2/53.8
C619	4030017420	S.CER C1005 CH 1H 470J-T	T	76.8/109.5
C620	4030017420	S.CER C1005 CH 1H 470J-T	T	73.8/97.8
C621	4030017420	S.CER C1005 CH 1H 470J-T	T	31.5/2.8
J601	6510027920	S.CON IMSA-9631S-28Y934	B	22.8/16.2
J602	6510023210	CON CD6125SA1J0 <CVI>		
S1	2260003070	S.SWI MINISMDC150F/24-2	B	38.9/18.0
W601	8900017500	CAB OPC-1852 (P0.5N28L90) <TJM>		

M.=Mounted side (T: Mounted on the Top side, B: Mounted on the Bottom side)
S.=Surface mount

BOARD LAYOUTS

The combination of this side and the bottom side shows the board layout in the same configuration as the actual P.C.Board.

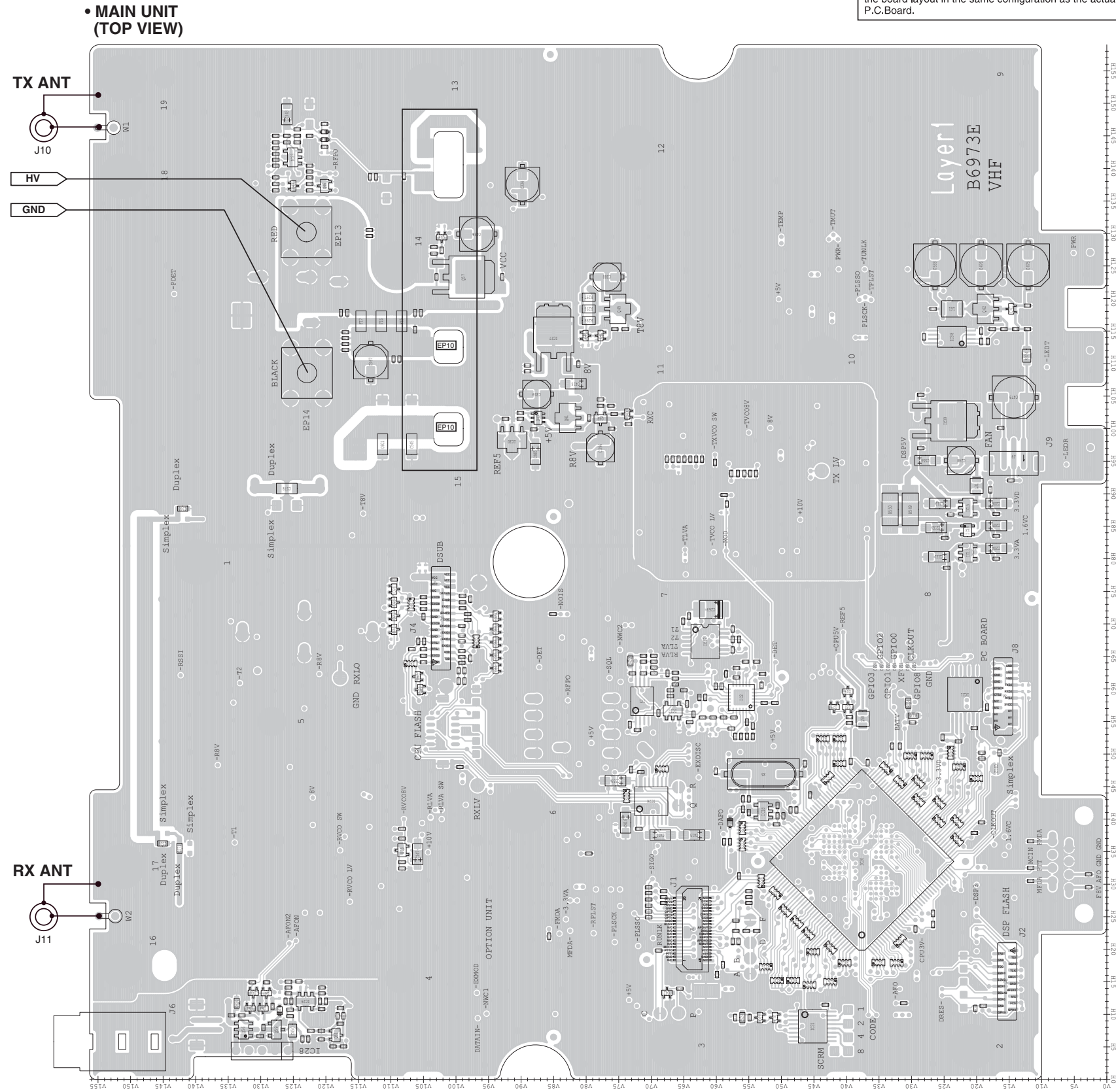

The combination of this side and the bottom side shows the board layout in the same configuration as the actual P.C.Board.

• MAIN UNIT
(BOTTOM VIEW)

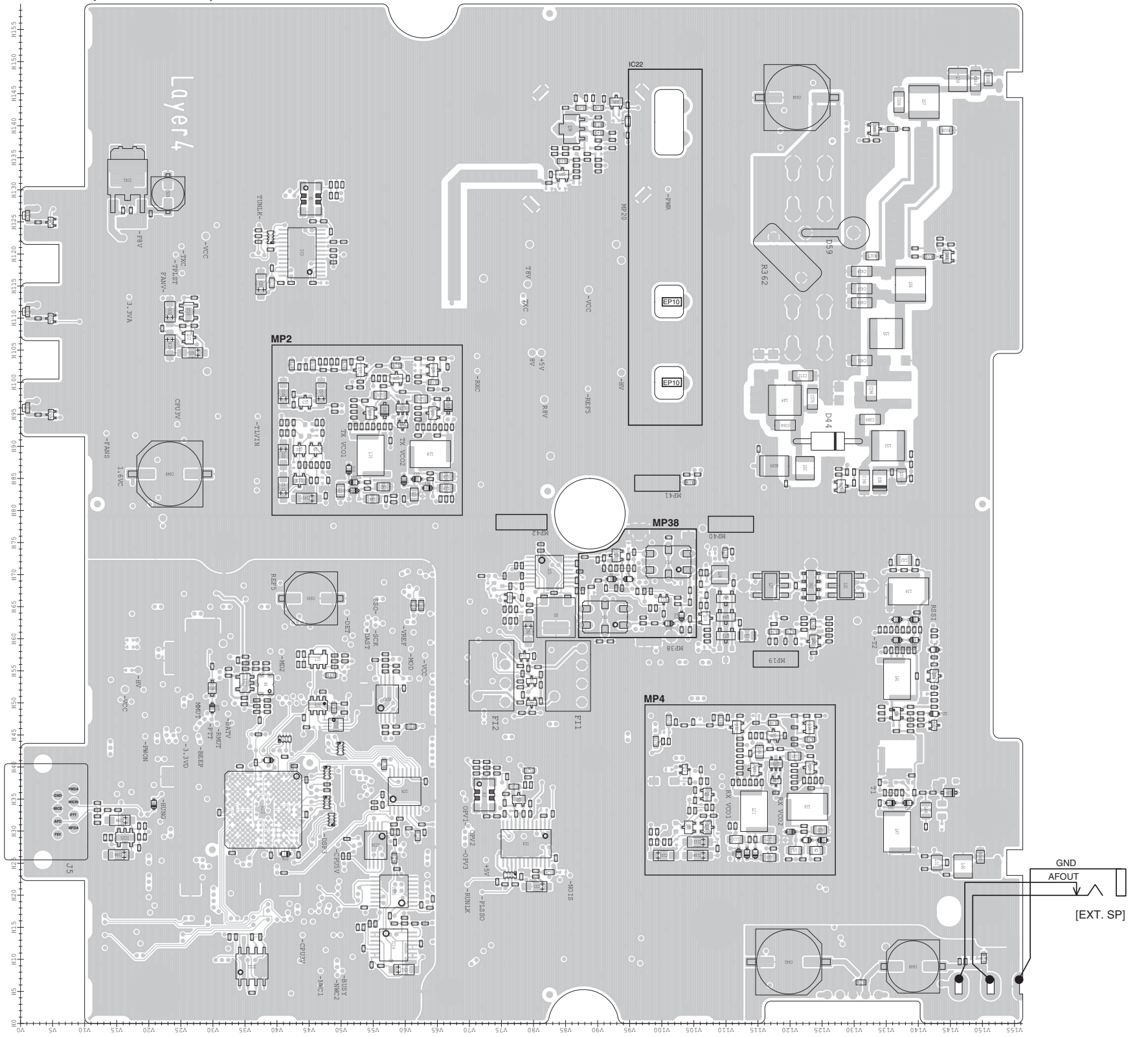

MAIN UNIT (2/3)

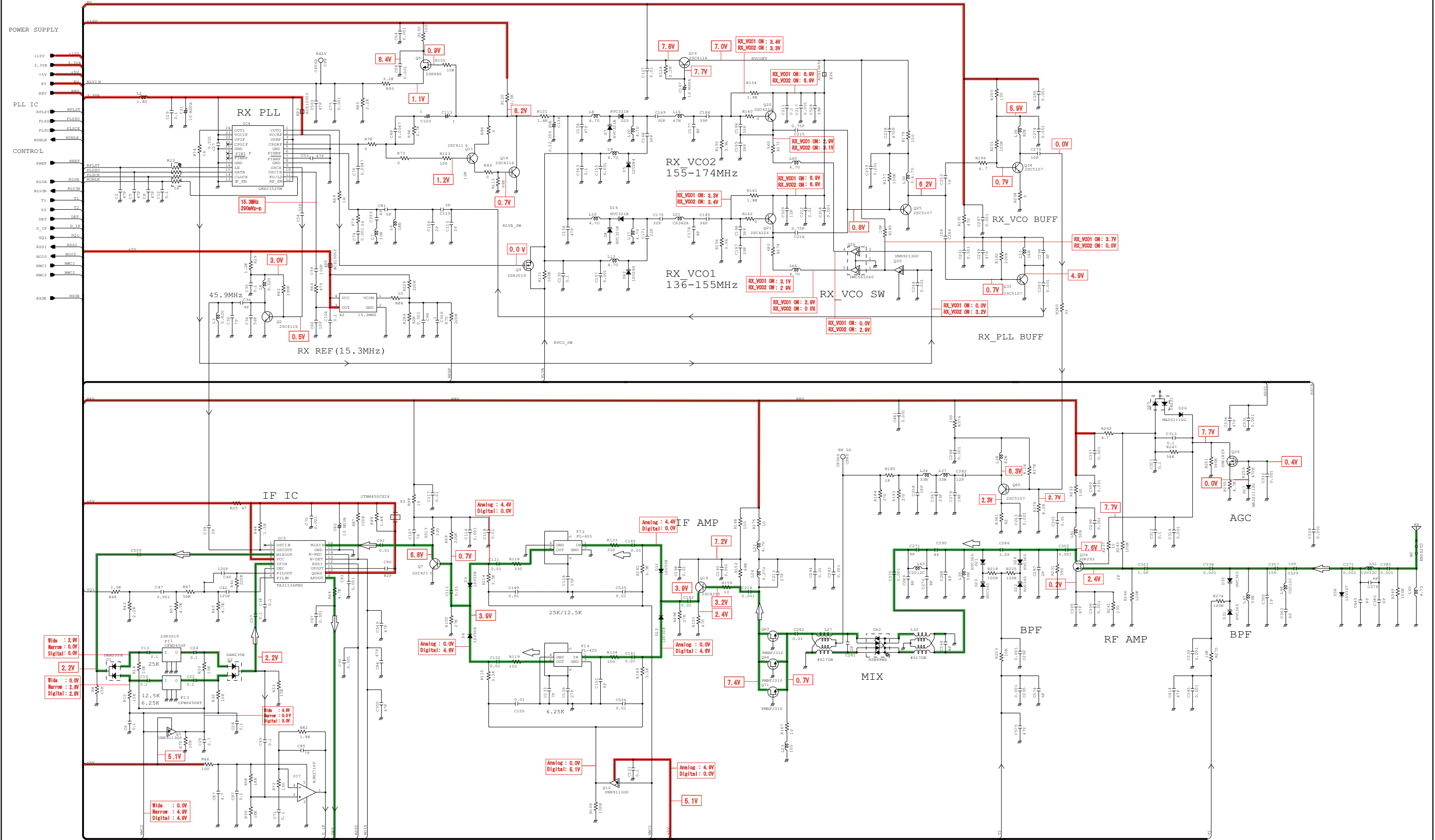

*; Refer to "PARTS LIST"

MAIN UNIT (3/3)

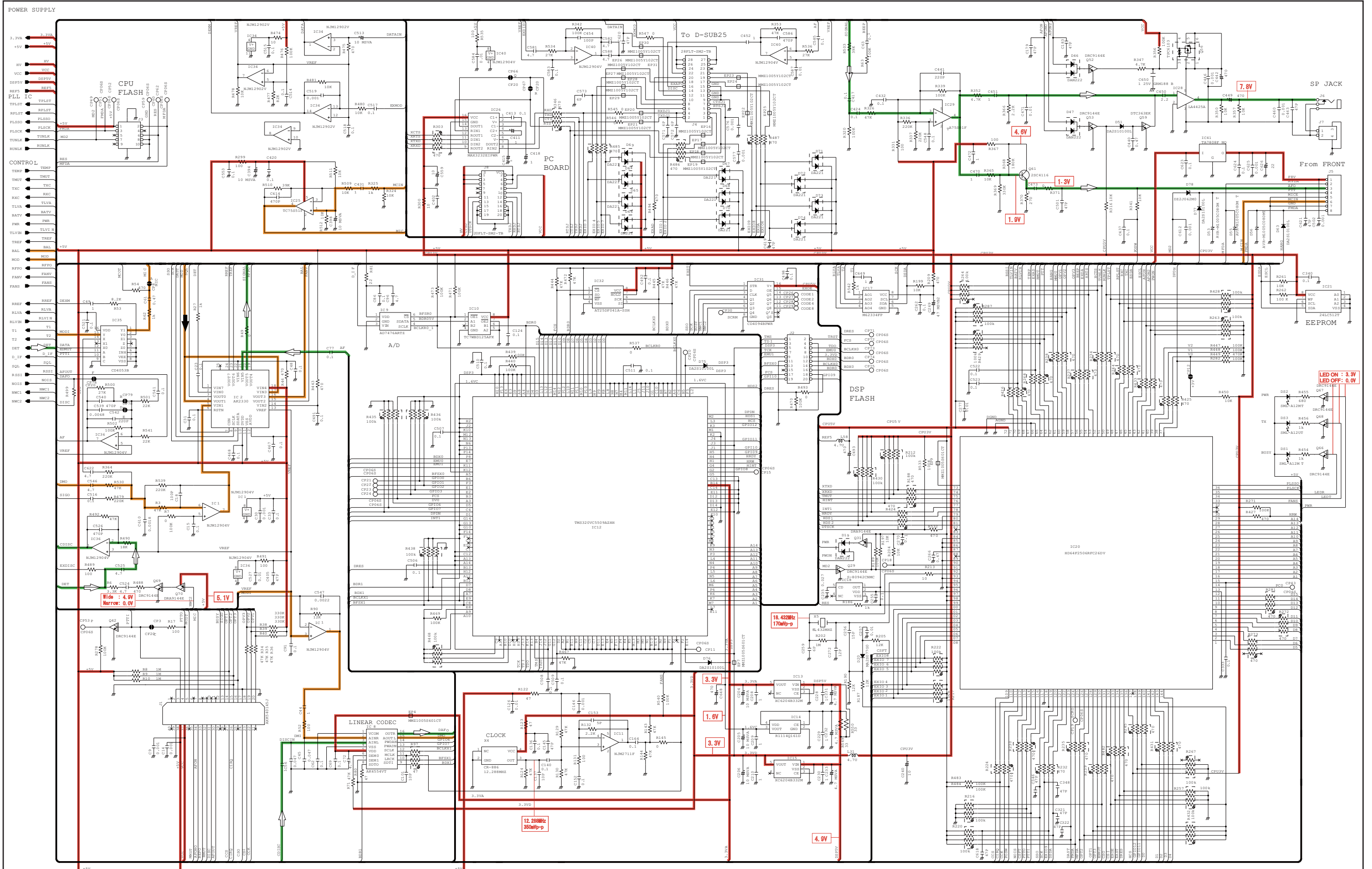

*; Refer to "PARTS LIST"

UR-FR5000 UR-FR5100

CONTENTS

REPLACEMENT PAGE	6-1
PARTS LIST	1
VOLTAGE DIAGRAM	8

[VERSION LIST]

Model	Version	Frequency range (MHz)	Channel spacing (kHz)	TX Power (W)
UR-FR5000	USA-01	136-174	7.5/15/30	50
	EXP-01		12.5/25.0	
UR-FR5100	EUR-01		12.5/20.0/25.0	25
	DPM-01		6.25/12.5/20.0/25.0	

SECTION 6 ADJUSTMENT PROCEDURE

6-1 PREPARATION

■ REQUIRED EQUIPMENTS

EQUIPMENT	SPECIFICATION	EQUIPMENT	SPECIFICATION
Adjustment Software	"CS-FR5000" (All models except [DPM-01]) "CS-FR5000(dPMR)" [DPM-01]	JIG cable	Modified OPC-1122U (USB type) (see the illust below)
Power Supply	Output voltage : 13.6 V DC [UR-FR5000] 13.2 V DC [UR-FR5100] Current capacity : More than 20 A [UR-FR5000] More than 10 A [UR-FR5100]	Attenuator	Power attenuation : 40 dB Capacity : More than 60 W [UR-FR5000] More than 30 W [UR-FR5100]
RF Power Meter (terminated type)	Measuring range : 1-60 W [UR-FR5000] 1-30 W [UR-FR5100] Frequency range : 100-300 MHz Impedance : 50 Ω SWR : Less than 1.2 : 1	Standard Signal Generator (SSG)	Frequency range : 0.1-300 MHz Output level : 0.1 mV to 32 mV (-127 to -17 dBm)
		Audio Generator	Frequency range : 300-3000 Hz Output level : 1-500 mV
Frequency Counter	Frequency range : 0.1-300 MHz Frequency accuracy: ±1 ppm or better Input level : Less than 1 mW	AC Millivoltmeter	Measuring range : 10 mV to 10 V
		Oscilloscope	Frequency range : DC-20 MHz Measuring range : 0.01-20 V
Modulation Analyzer	Frequency range : 30-300 MHz Measuring range : 0 to ±10 kHz	External Speaker	Input impedance : 4 Ω Capacity : More than 5 W

■ JIG CABLE

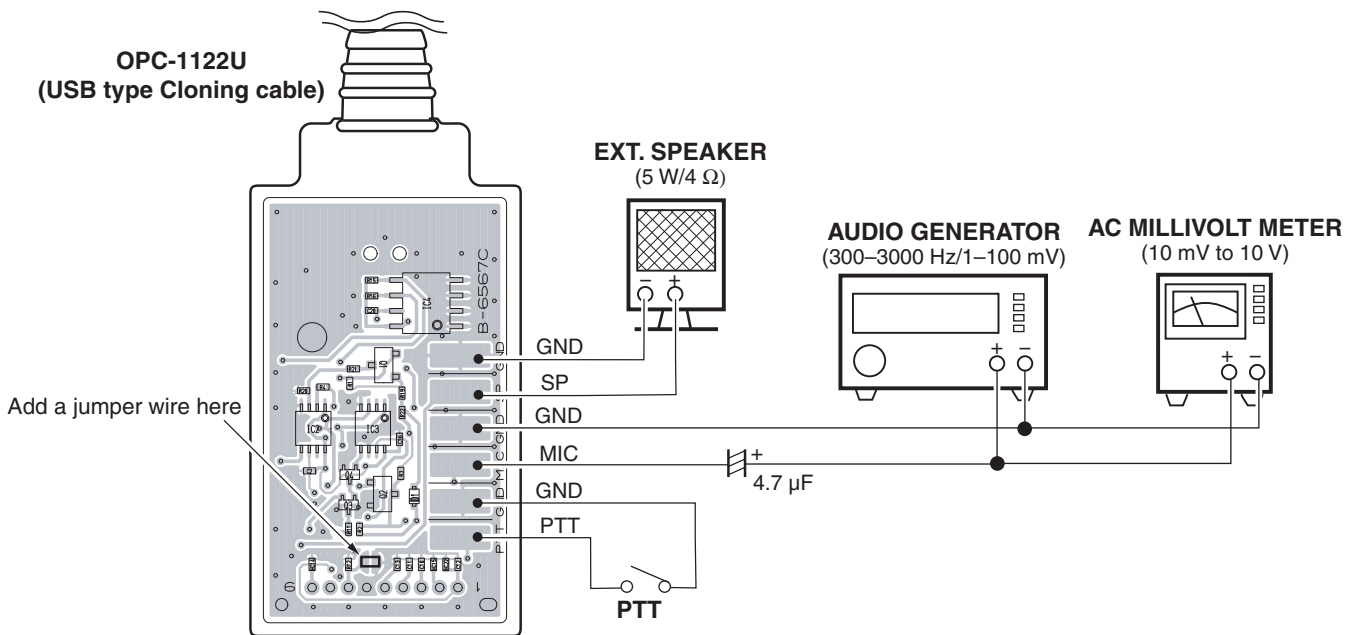

PARTS LIST

[MAIN UNIT]

REF NO.	PARTS NO.	DESCRIPTION	M.	H/V LOCATION
IC1	1110005330	S.IC NJM12904V-TE1-#ZZZB	T	58.1/71.4
IC2	1110007290	S.IC AK2330P-L	T	58.7/56.1
IC3	1130010100	S.IC LMX2352TMX/NOPB	B	120.2/43.9
IC4	1130010100	S.IC LMX2352TMX/NOPB	B	28/78.8
IC5	1110003491	S.IC TA31136FNG(D,EL)	B	70.4/82.5
IC7	1110007280	S.IC NJM2716F-TE1-#ZZZB	B	56.8/46.4
IC8	1130012910	S.IC AK4554VTP-E2/P	B	36.2/59.9
IC9	1190002080	S.IC AD7476ARTZ-500RL7 <FE>	B	49.6/46.4
IC10	1130013040	S.IC TC7WBD125AFK(T5L,F)	B	46.6/49.2
IC11	1110006230	S.IC NJM2711F-TE1-#ZZZB	B	53.1/35
IC12	1140013290	S.IC TMS320V/C5509AZHH	B	33.3/37.8
IC13	1180002590	S.REG XC6204B332MR	T	80.9/21.3
IC14	1180003270	S.REG R1114Q161D-TR-F	T	84.4/21.4
IC15	1180002590	S.REG XC6204B332MR	T	87.8/21.3
IC17	1190001340	S.IC M62334FP 600C	T	67.3/61.7
IC18	1110005771	S.IC S-80942CNMC-G9CT2G	T	41.2/52.8
IC19	1180003210	S.REG NJM2831F10-TE1-#ZZZB	B	111/26.2
IC20	1140014550	S.IC HD64F2506RFC26DV(EMPTY)	T	33.5/37.6
IC21	1140012950	S.IC 24LC512T-I/SM <SEI>	T	59.1/21.8
IC22	1150002073	IC RA60H1317M-125 [USA-01]		
	1150002073	IC RA60H1317M-125 [EXP-01]		
	1150002042	IC RA30H1317M-121 [EUR-01]		
	1150002042	IC RA30H1317M-121 [DPM-01]		
IC23	1110002751	S.IC TA75S01F(TE85R,F)	T	141.7/125.1
IC25	1130008561	S.IC TC75S51F(TE85L,F)	B	29/16.3
IC26	1120003070	S.IC MAX3232EIPWR	T	42.7/70
IC27	1180001252	S.IC TA7808F(TE16L1,NQ)	T	114.4/85
IC28	1110003091	IC LA4425A-E		
IC29	1110002751	S.IC TA75S01F(TE85R,F)	T	12/123.1
IC30	1110003390	S.IC AN8005M-(E1)	T	98.3/91.4
IC31	1130011760	S.IC CD4094BPWR	T	8.1/45.2
IC32	1130015410	S.IC AT25DF041A-SSH-T	B	8.9/36.1
IC34	1110005340	S.IC NJM12902V-TE1-#ZZZB	B	12.2/58.2
IC35	1140013200	S.IC CD4053BPWR	B	20.6/58.2
IC36	1110005330	S.IC NJM12904V-TE1-#ZZZB	B	27.8/55.4
IC37	1120002830	S.IC NJM2125F-TE1-#ZZZB	T	56.6/66.7
IC38	1110006380	S.IC LM2904PWR	T	114.1/23.8
IC39	1180001072	S.IC TA7805F(TE16L1,NQ)	T	101.2/24.3
IC40	1110005330	S.IC NJM12904V-TE1-#ZZZB	B	50.6/57.2
IC41	1180001252	S.IC TA7808F(TE16L1,NQ)	B	132/16.7
Q1	1590003231	S.TRA UNR9113G0L	B	53.4/79.7
Q2	1530002851	S.TRA 2SC4116-BL(TE85R,F)	B	34.9/77.7
Q3	1560001360	S.FET 2SK3019 TL	B	66.4/76.3
Q5	1560000541	S.FET 2SK880-Y(T5RICOM,F)	B	35.7/107.1
Q7	1530002601	S.TRA 2SC4215-O(TE85R,F)	B	73/92.9
Q8	1560000541	S.FET 2SK880-Y(T5RICOM,F)	B	89.5/46
Q9	1560001360	S.FET 2SK3019 TL	B	39.6/103.6
Q10	1530002851	S.TRA 2SC4116-BL(TE85R,F)	B	89.5/43.5
Q11	1530002851	S.TRA 2SC4116-BL(TE85R,F)	B	30.6/104.2
Q12	1590003231	S.TRA UNR9113G0L	B	66.1/100.3
Q13	1530002851	S.TRA 2SC4116-BL(TE85R,F)	B	84.7/43.5
Q14	1530002851	S.TRA 2SC4116-BL(TE85R,F)	B	30.6/107.1
Q15	1530002851	S.TRA 2SC4116-BL(TE85R,F)	B	96.9/44.4
Q16	1530002851	S.TRA 2SC4116-BL(TE85R,F)	T	35.2/108.3
Q19	1530002601	S.TRA 2SC4215-O(TE85R,F)	B	63.2/106.8
Q20	1530002920	S.TRA 2SC4226-T1 R25	B	39.9/123.1
Q21	1530002920	S.TRA 2SC4226-T1 R25	B	39.6/114.5
Q22	1530002920	S.TRA 2SC4226-T1 R25	B	95.2/64.3
Q23	1530002920	S.TRA 2SC4226-T1 R25	B	95.2/54.5
Q24	1530003311	S.TRA 2SC5107-O(TE85R,F)	B	100.6/58.6
Q25	1530003311	S.TRA 2SC5107-O(TE85R,F)	B	44.9/117.4
Q26	1590001400	S.TRA XP1214(TX)	B	40.5/117.8
Q27	1590001400	S.TRA XP1214(TX)	B	96/59.6
Q28	1590003291	S.TRA UNR9213G0L	B	93.3/59.6
Q29	1590003291	S.TRA UNR9213G0L	T	57.2/41.9
Q30	1590003291	S.TRA UNR9213G0L	B	37.8/117.8
Q31	1590003231	S.TRA UNR9113G0L	T	57.2/39.8
Q32	1530003311	S.TRA 2SC5107-O(TE85R,F)	B	46.2/111.7
Q33	1530003311	S.TRA 2SC5107-O(TE85R,F)	B	101.9/53
Q34	1530003311	S.TRA 2SC5107-O(TE85R,F)	B	46.2/123.1
Q35	1530003311	S.TRA 2SC5107-O(TE85R,F)	B	101.9/64.4
Q36	1580000731	S.FET 3SK293(TE85L,F)	B	48.3/136.6
Q37	1530003311	S.TRA 2SC5107-O(TE85R,F)	B	132.4/84.5
Q38	1530002680	S.TRA 2SC3357-T1	B	139.5/86
Q39	1560000841	S.FET 2SK1829(TE85R,F)	B	54.2/142.5
Q40	1590001190	S.TRA XP6501-(TX)AB	T	101.6/87.4
Q41	1520000460	S.TRA 2SB1132 T100 R	T	101.6/82.8
Q42	1590003291	S.TRA UNR9213G0L	T	13.3/67.6
Q43	1590003291	S.TRA UNR9213G0L	T	137.3/125
Q44	1590004150	S.TRA DRC9114T0L	T	114.3/80.1
Q45	1540000550	S.TRA 2SD1664 T100Q	T	118.4/75.2
Q46	1530002851	S.TRA 2SC4116-BL(TE85R,F)	T	137.3/120.2
Q48	1510000920	S.TRA 2SA1577 T106 Q	T	101.5/77.8
Q49	1590003291	S.TRA UNR9213G0L	T	102.2/73.7
Q52	1590003291	S.TRA UNR9213G0L	T	10.9/131.6
Q53	1590003291	S.TRA UNR9213G0L	T	10.9/129.6
Q56	1590003560	S.FET TPC6104 (TE85L,F)	T	7.6/132.6
Q57	1550000190	S.FET 2SJ506STR-E	T	123.3/99.6
Q58	1590003291	S.TRA UNR9213G0L	T	129.4/102.2
Q59	1590000990	S.TRA DTC363EK T146	T	7.6/127.6
Q61	1530002851	S.TRA 2SC4116-BL(TE85R,F)	T	6.8/118.4
Q62	1540000441	S.TRA 2SD1619T-D-E	T	118.4/18.6
Q63	1560000990	S.FET PMBFJ310	B	66.3/110
Q64	1560000990	S.FET PMBFJ310	B	63.4/110
Q65	1530003311	S.TRA 2SC5107-O(TE85R,F)	B	59.6/123.7
Q66	1590003291	S.TRA UNR9213G0L	B	94.9/4.7

[MAIN UNIT]

REF NO.	PARTS NO.	DESCRIPTION	M.	H/V LOCATION
Q67	1590003291	S.TRA UNR9213G0L	B	124.9/4.7
Q68	1590003291	S.TRA UNR9213G0L	B	109.9/4.7
Q69	1590003291	S.TRA UNR9213G0L	T	9.5/53.3
Q70	1590003231	S.TRA UNR9113G0L	T	9.5/51
Q71	1560000990	S.FET PMBFJ310	B	60.5/110
Q72	1530002851	S.TRA 2SC4116-BL(TE85R,F)	B	107/26.3
D1	1750001070	S.DIO DAN235ETL	B	57.3/78.6
D2	1750001070	S.DIO DAN235ETL	B	50/79.7
D3	1790001621	S.DIO 1SV308(TPL3,F)	B	69.3/94.8
D4	1790001621	S.DIO 1SV308(TPL3,F)	B	69.3/92.2
D5	1720000641	S.VAR 1SV284(TPH3,F)	B	29.9/120.1
D7	1720000791	S.VAR HVC321B1TRF-E	B	28.6/125.1
D8	1720000791	S.VAR HVC321B1TRF-E	B	26.5/113.3
D9	1720000791	S.VAR HVC321B1TRF-E	B	84.7/59.8
D10	1720000919	S.VAR HVC321B1TRF-E	B	86.4/51.2
D11	1790001621	S.DIO 1SV308(TPL3,F)	B	63.5/103.1
D12	1790001621	S.DIO 1SV308(TPL3,F)	B	62.4/101.1
D13	1720000791	S.VAR HVC321B1TRF-E	B	84.9/61.8
D14	1720000791	S.VAR HVC321B1TRF-E	B	84.4/52
D15	1720000791	S.VAR HVC321B1TRF-E	B	28.6/122.6
D16	1720000791	S.VAR HVC321B1TRF-E	B	26.5/114.6
D17	1720000641	S.VAR 1SV284(TPH3,F)	B	83.5/63.5
D18	1720000471	S.VAR 1SV239(TPH3,F)	B	96.3/66.7
D19	1750000520	S.DIO DAN222TL	T	59.6/39.8
D20	1790001261	S.DIO MA2S077G0L	T	39.5/57.9
D21	1750001610	S.VAR HVC365TRF-E	B	63/139.4
D22	1750001610	S.VAR HVC365TRF-E	B	59.8/136.7
D23	1750001610	S.VAR HVC365TRF-E	B	63/136.7
D24	1750001610	S.VAR HVC365TRF-E	B	59.8/139.4
D25	1750000370	S.DIO DA221 TL	B	46.5/142.5
D26	1790001251	S.DIO MA2S1110GL	B	48.3/142.5
D27	1790001251	S.DIO MA2S1110GL	B	58.3/142.5
D30	1720000471	S.VAR 1SV239(TPH3,F)	B	95.6/56.8
D31	1750001610	S.VAR HVC365TRF-E	B	34.4/135.7
D32	1750001610	S.VAR HVC365TRF-E	B	34.4/138.4
D35	1750000351	S.DIO 1SV252(TE85L,F)	B	143.7/92.9
D36	1750001080	S.DIO RB886G T2R	T	144.4/120.2
D37	1750001080	S.DIO RB886G T2R	T	145.6/120.2
D38	1750001360	S.DIO L709CER (9401)	B	84.7/134
D39	1750000581	S.DIO 1SV307(TPH3,F)	B	36/144.8
D40	1750000370	S.DIO DA221 TL	T	114.3/77.8
D42	1720000641	S.VAR 1SV284(TPH3,F)	B	26.5/112
D44	1710001061	DIO L407CDB		
D45	1790001211	S.DIO 1SS375-TL-E	B	83.8/128
D46	1750000520	S.DIO DAN222TL	T	13.3/131.1
D47	1750000520	S.DIO DAN222TL	T	13.2/129.1
D48	1790001211	S.DIO 1SS375-TL-E	B	119.6/144.5
D49	1790001211	S.DIO 1SS375-TL-E	B	139.5/133.2
D51	1790001251	S.DIO MA2S1110GL	T	10.5/127.1
D53	1790001810	S.VAR AVR-M1005C080MTABB	T	32.5/11.7
D55	1790001810	S.VAR AVR-M1005C080MTABB	T	30.5/11.7
D56	1790001810	S.VAR AVR-M1005C080MTABB	T	36.6/11.7
D59	1790000700	DIO DSA3A1		
D61	1750000520	S.DIO DAN222TL	T	118.4/14.7
D62	1750000431	S.DIO HSB88WSTR-E	B	68.3/123.3
D63	1790001251	S.DIO MA2S1110GL	B	34.2/20.8
D64	1750000370	S.DIO DA221 TL	T	63.2/93.9
D65	1750000370	S.DIO DA221 TL	T	65.2/93.9
D66	1750000370	S.DIO DA221 TL	T	67.2/93.9
D67	1750000370	S.DIO DA221 TL	T	61.9/105.9
D68	1750000370	S.DIO DA221 TL	T	59.9/105.5
D69	1750000370	S.DIO DA221 TL	T	69.2/93.9
D70	1750000370	S.DIO DA221 TL	T	71.2/93.9
D71	1750000370	S.DIO DA221 TL	T	69.1/109.5
D72	1750000370	S.DIO DA221 TL	T	71.2/109.5
D73	1750000370	S.DIO DA221 TL	T	73.3/109.5
D74	1750000370	S.DIO DA221 TL	T	75.3/109.5
D75	1790001251	S.DIO MA2S1110GL	B	41/38.6
D76	1790001251	S.DIO MA2S1110GL	B	26.4/41.3
D77	1790001251	S.DIO MA2S1110GL	B	49.2/29.9
D78	1730002361	S.ZEN MAZ8062GML	B	52.3/29.9
D79	1720000641	S.VAR 1SV284(TPH3,F)	B	83.1/72
F11	2020001520	CER CFWLA450KFFA-B0 (CFWS450F)		
F12	2020001460	CER CFWLA450KHFA-B0 (CFWS450HT)		
F13	2030000500	S.MON DSF753SBF 46.35 MHz (FL-401)	B	72/101
F14	2030000670	S.MON DSF753SBF 46.35 MHz (FL-420)	B	63.4/91.1
F15	2040001440	S.LC NFE31PT152Z1E9L (NFM60R20T152)	T	116.5/108.3
F16	2040001440	S.LC NFE31PT152Z1E9L (NFM60R20T152)	T	116.5/111.5
F17	2040001440	S.LC NFE31PT152Z1E9L (NFM60R20T152)	T	116.5/114.6
X1	6050012380	S.XTA CR-826 DSA535SD 15.3 MHz	B	128.6/45.3
X2	6050012380	S.XTA CR-826 DSA535SD 15.3 MHz	B	35.6/73.5
X3	6070000300	S.DIS JTBM450CX24 <LJE>	B	63.5/83.3
X4	6050012930	S.XTA CR-886 DSA321SCA 12.288 MHz	B	52.8/38.2
X5	6050012680	S.XTA CR-858(SMD-49/18.432 MHz) <LJE>	T	46.9/52.7

M.=Mounted side (T: Mounted on the Top side, B: Mounted on the Bottom side) S.=Surface mount

[MAIN UNIT]

REF NO.	PARTS NO.	DESCRIPTION	M.	H/V LOCATION
L1	6200004660	S.COI MLF1608A 1R8K-T	B	115.5/39.2
L2	6200004660	S.COI MLF1608A 1R8K-T	B	23.6/82.4
L3	6200004480	S.COI MLF1608D R82K-T	B	39.4/79.3
L4	6200003540	S.COI MLF1608D R22K-T	B	36.9/76.9
L5	6200005691	S.COI ELJRE 18NGFA	B	102.7/45.6
L6	6200005691	S.COI ELJRE 18NGFA	B	47.3/101.1
L7	6200005661	S.COI ELJRE 10NGFA	B	44/99.1
L8	6200007120	S.COI ELJND 1R0J	B	27/124.1
L9	6200007120	S.COI ELJND 1R0J	B	27/120.8
L10	6200007120	S.COI ELJND 1R0J	B	25.9/116.8
L11	6200007120	S.COI ELJND 1R0J	B	82.5/61.4
L12	6200007120	S.COI ELJND 1R0J	B	83.1/49.9
L13	6200007120	S.COI ELJND 1R0J	B	28.7/111.6
L14	6200007120	S.COI ELJND 1R0J	B	85.3/66.4
L15	6200013220	S.COI C6342A-R13G-A	B	88.6/54.6
L16	6200010600	S.COI C6342A-67NG-A	B	33.8/122.7
L17	6200007120	S.COI ELJND 1R0J	B	28.7/116.8
L18	6200009910	S.COI C6342A-88NG-A	B	88.8/63.9
L19	6200007120	S.COI ELJND 1R0J	B	83.5/66.4
L20	6200007120	S.COI ELJND 1R0J	B	30.2/124.7
L21	6200009910	S.COI C6342A-88NG-A	B	33.1/114.4
L22	6200003550	S.COI MLF1608A 4R7K-T	B	73.4/109.9
L23	6200005011	S.COI NLV25T-100J	B	60.5/113.3
L24	6200010740	S.COI C2520C-R27G-A	B	70/109.1
L25	6200007120	S.COI ELJND 1R0J	B	97.4/62.5
L26	6200007120	S.COI ELJND 1R0J	B	98/56.1
L27	6130002961	S.COI #617DB-1327=P3	B	68.3/117
L28	6200007001	S.COI ELJRE 82NGFA	B	62.3/123.6
L29	6200006981	S.COI ELJRE R10GFA	B	102.6/58.6
L30	6200006981	S.COI ELJRE R10GFA	B	46.9/117.4
L31	6200002861	S.COI NLV25T-4R7J	T	91.2/20
L32	6130002961	S.COI #617DB-1327=P3	B	68.3/128.7
L33	6200005691	S.COI ELJRE 18NGFA	B	47.3/109.2
L34	6200005721	S.COI ELJRE 33NGFA	B	61.1/117.5
L35	6200005691	S.COI ELJRE 18NGFA	B	102.7/50.5
L36	6200007001	S.COI ELJRE 82NGFA	B	44.3/123.1
L37	6200005721	S.COI ELJRE 33NGFA	B	61.1/120.1
L38	6200007001	S.COI ELJRE 82NGFA	B	100/64.4
L39	6200010610	S.COI C6342A-50NG-A	B	67.4/138.5
L41	6200010610	S.COI C6342A-50NG-A	B	53.7/136.7
L42	6200006981	S.COI ELJRE R10GFA	B	134.5/84.5
L43	6200006671	S.COI ELJRE 68NGFA	B	138.9/90.1
L45	6200005741	S.COI ELJRE 47NGFA	B	142.8/87.4
L46	6200005741	S.COI ELJRE 47NGFA	B	142.8/90.1
L47	6200010610	S.COI C6342A-50NG-A	B	29.9/136.7
L48	6200010000	S.COI C2012C-56NG-A	B	33.3/141.2
L49	6200010050	S.COI AS080547-47N	B	97.2/119.2
L50	6200007750	S.COI LQW2BHNS6NJ03L	B	85.5/137.4
L51	6200010000	S.COI C2012C-56NG-A	B	25.1/142.9
L52	6200010420	S.COI FHW1210HC 1R0JGT <JJE>	B	86.6/122.3
L53	6200010050	S.COI AS080547-47N	B	90.1/135.3
L55	6200010050	S.COI AS080547-47N	B	107.6/135
L56	6200010050	S.COI AS080547-47N	B	115.2/138.8
L57	6200010050	S.COI AS080547-47N	B	143.7/140.9
L58	6200002861	S.COI NLV25T-4R7J	T	55.4/37.5
L59	6200010420	S.COI FHW1210HC 1R0JGT <JJE>	B	147.1/146.2
L60	6200010420	S.COI FHW1210HC 1R0JGT <JJE>	B	24.5/147
L61	6200002961	S.COI NLV32T-4R7J	T	118.4/23.8
L62	6200013530	S.COI MLF2012E 100K-T	B	83.7/56.6
L63	6200010000	S.COI C2012C-56NG-A	B	72.3/137.8
L64	6200007120	S.COI ELJND 1R0J	B	81.8/54.9
L65	6200007120	S.COI ELJND 1R0J	B	41.7/120.7
L66	6200007120	S.COI ELJND 1R0J	B	42.4/115.2
L68	6200003960	S.COI MLF1608A 1R0K-T	B	140.7/94.7
L69	6200005661	S.COI ELJRE 10NGFA	B	102.7/42.3
R1	7030005310	S.RES ERJ2GEJ 124 X (120K)	T	54.9/64.1
R2	7030005050	S.RES ERJ2GEJ 103 X (10K)	T	58.7/61.7
R3	7030005240	S.RES ERJ2GEJ 473 X (47K)	T	62.4/69.6
R4	7030007340	S.RES ERJ2GEJ 153 X (15K)	T	57.3/80.1
R6	7030007300	S.RES ERJ2GEJ 332 X (3.3K)	T	9.5/57.1
R7	7030010040	S.RES ERJ2GEJ-JPW	T	61.6/66.3
R8	7030005160	S.RES ERJ2GEJ 105 X (1M)	T	24.9/70.4
R9	7030005160	S.RES ERJ2GEJ 105 X (1M)	T	25.8/70.4
R10	7030005160	S.RES ERJ2GEJ 105 X (1M)	T	26.7/70.4
R12	7510001730	S.THE ERTJOEP 473J	B	129.1/49.3
R13	7030005090	S.RES ERJ2GEJ 104 X (100K)	B	130.8/49.3
R15	7030007340	S.RES ERJ2GEJ 153 X (15K)	B	54.5/78.3
R17	7030004980	S.RES ERJ2GEJ 101 X (100)	T	19.8/68.8
R18	7030007340	S.RES ERJ2GEJ 153 X (15K)	B	55.3/79.2
R20	7030009150	S.RES ERJ2GEJ 824 X (820K)	T	56.1/63.5
R22	7410001130	S.ARR EXB28V102JX	B	122.6/39
R23	7410001130	S.ARR EXB28V102JX	B	23.1/76.3
R24	7030005120	S.RES ERJ2GEJ 102 X (1K)	B	115.5/42.2
R25	7030004970	S.RES ERJ2GEJ 470 X (47K)	B	65.3/79.4
R26	7030010040	S.RES ERJ2GEJ-JPW	T	57.7/64.5
R27	7030005120	S.RES ERJ2GEJ 102 X (1K)	T	57.8/51
R29	7030007570	S.RES ERJ2GEJ 122 X (1.2K)	B	38.5/75.9
R30	7030007340	S.RES ERJ2GEJ 153 X (15K)	B	52.8/81.1
R32	7030007340	S.RES ERJ2GEJ 153 X (15K)	B	51.2/78.3
R33	7030007340	S.RES ERJ2GEJ 153 X (15K)	B	48.4/78.2
R34	7030005240	S.RES ERJ2GEJ 473 X (47K)	T	27.1/68.1
R35	7030005240	S.RES ERJ2GEJ 473 X (47K)	T	28/68.1
R36	7030005240	S.RES ERJ2GEJ 473 X (47K)	T	28.9/68.1
R38	7030005230	S.RES ERJ2GEJ 334 X (330K)	T	27.6/70.4
R39	7030005230	S.RES ERJ2GEJ 334 X (330K)	T	28.6/70.4
R40	7030005230	S.RES ERJ2GEJ 334 X (330K)	T	29.5/70.4
R41	7030005110	S.RES ERJ2GEJ 224 X (220K)	B	68.2/78.2
R42	7030006610	S.RES ERJ2GEJ 394 X (390K)	B	34.4/75.5
R43	7030007290	S.RES ERJ2GEJ 222 X (2.2K)	B	62.8/77.3
R44	7030005030	S.RES ERJ2GEJ 152 X (1.5K)	B	71.4/78.2
R45	7030005040	S.RES ERJ2GEJ 472 X (4.7K)	B	64.6/75.5
R46	7030005000	S.RES ERJ2GEJ 471 X (470)	T	52.7/57.1
R47	7030005720	S.RES ERJ2GEJ 563 X (56K)	B	64.6/76.4

[MAIN UNIT]

REF NO.	PARTS NO.	DESCRIPTION	M.	H/V LOCATION
R48	7030005030	S.RES ERJ2GEJ 152 X (1.5K)	B	62.8/76.4
R49	7030010040	S.RES ERJ2GEJ-JPW	T	55.6/57.3
R52	7030004980	S.RES ERJ2GEJ 101 X (100)	B	34.1/56.4
R53	7030005050	S.RES ERJ2GEJ 822 X (8.2K)	B	16.8/57.6
R54	7030005000	S.RES ERJ2GEJ 471 X (4.7K)	B	19.4/64.3
R56	7030004970	S.RES ERJ2GEJ 470 X (47)	B	121.9/50.4
R57	7030005040	S.RES ERJ2GEJ 472 X (4.7K)	B	62.8/75.5
R58	7030008290	S.RES ERJ2GEJ 183 X (18K)	B	56.5/49
R59	7030008290	S.RES ERJ2GEJ 183 X (18K)	B	57.4/49
R60	7030005000	S.RES ERJ2GEJ 471 X (470)	B	32.3/74.3
R62	7030005120	S.RES ERJ2GEJ 102 X (1K)	B	18.5/62.5
R63	7030005090	S.RES ERJ2GEJ 104 X (100K)	T	55.6/60.5
R65	7030005000	S.RES ERJ2GEJ 471 X (470)	B	125.1/47.3
R66	7030004980	S.RES ERJ2GEJ 101 X (100)	B	56.5/50.6
R68	7030005040	S.RES ERJ2GEJ 472 X (4.7K)	B	67.5/86.7
R69	7030005120	S.RES ERJ2GEJ 102 X (1K)	B	32.7/83
R70	7030005050	S.RES ERJ2GEJ 103 X (10K)	B	69.8/71.9
R71	7030005240	S.RES ERJ2GEJ 473 X (47K)	B	31/62.6
R72	7030004980	S.RES ERJ2GEJ 101 X (100)	B	57.6/44.2
R73	7030010040	S.RES ERJ2GEJ-JPW	B	28.3/100.4
R74	7030005120	S.RES ERJ2GEJ 102 X (1K)	B	25.8/83.5
R75	7030005110	S.RES ERJ2GEJ 224 X (220K)	B	39.9/71.1
R76	7030010040	S.RES ERJ2GEJ-JPW	B	93.7/41.6
R77	7030005580	S.RES ERJ2GEJ 560 X (56)	B	119.7/48.8
R78	7030010040	S.RES ERJ2GEJ-JPW	B	29.9/99.3
R79	7030005580	S.RES ERJ2GEJ 560 X (56)	B	32.7/79.5
R80	7030004970	S.RES ERJ2GEJ 470 X (47)	B	23.5/41.1
R81	7030007250	S.RES ERJ2GEJ 220 X (22)	B	49.9/50.5
R82	7030008400	S.RES ERJ2GEJ 182 X (1.8K)	B	56/44.2
R83	7030010040	S.RES ERJ2GEJ-JPW	B	32.4/106.5
R84	7030007290	S.RES ERJ2GEJ 222 X (2.2K)	B	93.7/47.1
R85	7030007290	S.RES ERJ2GEJ 222 X (2.2K)	B	37.8/107.1
R86	7030010040	S.RES ERJ2GEJ-JPW	B	33.2/105.2
R87	7030005090	S.RES ERJ2GEJ 104 X (100K)	B	73.7/81.1
R88	7030005530	S.RES ERJ2GEJ 100 X (10)	B	39/71.1
R89	7030008400	S.RES ERJ2GEJ 182 X (1.8K)	B	67.1/83.2
R90	7030008010	S.RES ERJ2GEJ 123 X (12K)	T	54.5/73.3
R91	7030007290	S.RES ERJ2GEJ 222 X (2.2K)	B	92.1/47.1
R92	7030009140	S.RES ERJ2GEJ 272 X (2.7K)	B	92.1/41.6
R93	7030007290	S.RES ERJ2GEJ 222 X (2.2K)	B	37.8/106.1
R94	7030009140	S.RES ERJ2GEJ 272 X (2.7K)	B	28.3/98.3
R97	7410001170	S.ARR EXB28V470JX	B	42.9/49.9
R98	7030005530	S.RES ERJ2GEJ 100 X (10)	B	71/95.7
R99	7030005110	S.RES ERJ2GEJ 224 X (220K)	B	71/92.9
R100	7030005600	S.RES ERJ2GEJ 273 X (27K)	B	67.9/93.8
R101	7030004980	S.RES ERJ2GEJ 101 X (100)	B	92.1/42.6
R102	7030004980	S.RES ERJ2GEJ 101 X (100)	B	34.8/105.2
R103	7030004980	S.RES ERJ2GEJ 101 X (100)	B	28.3/101.3
R105	7030005050	S.RES ERJ2GEJ 103 X (10K)	B	33.7/107.9
R107	7030004980	S.RES ERJ2GEJ 101 X (100)	B	87.1/47.1
R109	7030005090	S.RES ERJ2GEJ 104 X (100K)	B	64.8/98.2
R111	7030005090	S.RES ERJ2GEJ 104 X (100K)	B	37.8/104.4
R112	7030005070	S.RES ERJ2GEJ 683 X (68K)	B	84.7/45.3
R113	7030005070	S.RES ERJ2GEJ 683 X (68K)	B	32.4/108.1
R114	7030007300	S.RES ERJ2GEJ 332 X (3.3K)	B	67.4/96.2
R115	7030007300	S.RES ERJ2GEJ 332 X (3.3K)	B	67.9/91.3
R116	7030005050	S.RES ERJ2GEJ 103 X (10K)	B	87.1/45.3
R117	7030005810	S.RES RR0510P-152-D (1.5K)	B	87.1/46.2
R118	7030007280	S.RES ERJ2GEJ 31 X (330)	B	72.8/94.8
R119	7030007270	S.RES ERJ2GEJ 151 X (150)	B	68.1/89
R120	7030005810	S.RES RR0510P-152-D (1.5K)	B	33.7/107.9
R121	7030008400	S.RES ERJ2GEJ 182 X (1.8K)	B	27.3/108.7
R122	7030004970	S.RES ERJ2GEJ 470 X (47)	B	56.6/33.9
R123	7030004970	S.RES ERJ2GEJ 470 X (47)	B	49.5/38.5
R124	7030005240	S.RES ERJ2GEJ 473 X (47K)	B	55.3/38.3
R125	7030008280	S.RES ERJ2GEJ 271 X (270)	B	84.7/46.2
R126	7030007290	S.RES ERJ2GEJ 222 X (2.2K)	B	96.5/42.6
R127	7030005720	S.RES ERJ2GEJ 563 X (56K)	T	88.4/58.4
R128	7030007290	S.RES ERJ2GEJ 222 X (2.2K)	T	33.4/108.3
R129	7030005240	S.RES ERJ2GEJ 473 X (47K)	B	55.3/35.1
R130	7030005240	S.RES ERJ2GEJ 473 X (47K)	B	56.2/36.7
R131	7030004980	S.RES ERJ2GEJ 101 X (100)	B	54.2/32.4
R132	7030007290	S.RES ERJ2GEJ 222 X (2.2K)	B	50.8/34.9
R133	7030007280	S.RES ERJ2GEJ 331 X (330)	B	67.5/104.4
R134	7030007270	S.RES ERJ2GEJ 151 X (150)	B	62.4/97.1
R136	7030005110	S.RES ERJ2GEJ 224 X (220K)	B	81.8/65.5
R137	7030005110	S.RES ERJ2GEJ 224 X (220K)	B	81.8/57
R138	7030005240	S.RES ERJ2GEJ 473 X (47K)	T	95.3/65.8
R139	7030005060	S.RES ERJ2GEJ 333 X (33K)	T	95.3/64.9
R140	7030007300	S.RES ERJ2GEJ 332 X (3.3K)	B	63.9/100.3
R141	7030005060	S.RES ERJ2GEJ 333 X (33K)	T	95.3/60.4
R142	7030007300	S.RES ERJ2GEJ 332 X (3.3K)	B	65.4/102.5
R143	7030005240	S.RES ERJ2GEJ 473 X (47K)	B	

[MAIN UNIT]

REF NO.	PARTS NO.	DESCRIPTION	M.	H/V LOCATION
R169	7030008340	S.RES RR0510P-182-D (1.8K)	B	93.1/53.2
R171	7030011920	S.RES RR0510P-561-D (560)	B	41.7/123.2
R172	7030009820	S.RES RR0510P-681-D (680)	B	97.4/65
R173	7030009820	S.RES RR0510P-681-D (680)	B	97.2/53.7
R174	7030009820	S.RES RR0510P-681-D (680)	B	42.1/113.8
R175	7030005530	S.RES ERJ2GEJ 100 X (10)	B	73.6/111
R176	7030005090	S.RES ERJ2GEJ 104 X (100K)	B	100.6/56.8
R177	7030005090	S.RES ERJ2GEJ 104 X (100K)	B	44.9/115.6
R178	7030004980	S.RES ERJ2GEJ 101 X (100)	B	100.6/55.9
R179	7030004980	S.RES ERJ2GEJ 101 X (100)	B	44.9/114.7
R180	7030005050	S.RES ERJ2GEJ 103 X (10K)	T	37/108.3
R181	7030005050	S.RES ERJ2GEJ 103 X (10K)	B	96.4/49
R184	7030008280	S.RES ERJ2GEJ 271 X (270)	B	63.2/119.1
R185	7030010090	S.RES ERJ2GEJ 180 X (18)	B	62.3/117.5
R186	7030005120	S.RES ERJ2GEJ 102 X (1K)	T	39.2/50.7
R187	7030008010	S.RES ERJ2GEJ 123 X (12K)	T	41.5/55.9
R188	7410001150	S.ARR EXB28V471JX	T	48.5/41.1
R189	7030005090	S.RES ERJ2GEJ 104 X (100K)	T	55.6/39.5
R190	7030008010	S.RES ERJ2GEJ 123 X (12K)	T	43.1/55.9
R191	7030005000	S.RES ERJ2GEJ 471 X (470)	B	43.5/112.2
R192	7030005110	S.RES ERJ2GEJ 224 X (220K)	B	44.4/112.2
R193	7030008280	S.RES ERJ2GEJ 271 X (270)	B	59.6/116.8
R194	7030004980	S.RES ERJ2GEJ 101 X (100)	B	99.2/53
R195	7030005110	S.RES ERJ2GEJ 224 X (220K)	B	100.1/53
R196	7030009320	S.RES ERJ2GEJ 4R7 X (4.7)	B	48/120.7
R197	7030005050	S.RES ERJ2GEJ 103 X (10K)	T	40.5/50.6
R198	7030009320	S.RES ERJ2GEJ 4R7 X (4.7)	B	103.7/62
R199	7030005050	S.RES ERJ2GEJ 103 X (10K)	T	67.6/57.5
R200	7030004980	S.RES ERJ2GEJ 101 X (100)	B	43.1/123.1
R201	7030005090	S.RES ERJ2GEJ 104 X (100K)	B	48/122.6
R202	7030005160	S.RES ERJ2GEJ 105 X (1M)	T	41.4/48.6
R204	7030005050	S.RES ERJ2GEJ 103 X (10K)	T	54.7/39.5
R205	7030008010	S.RES ERJ2GEJ 123 X (12K)	T	36.5/57.9
R207	7030005090	S.RES ERJ2GEJ 104 X (100K)	B	103.7/64
R208	7030010040	S.RES ERJ2GEJ-JPW	B	46.2/120.7
R209	7030005000	S.RES ERJ2GEJ 471 X (470)	T	67.6/56.5
R212	7410001140	S.ARR EXB28V104JX	T	52.3/41.1
R213	7030005530	S.RES ERJ2GEJ 100 X (10)	T	41.4/47.7
R214	7030004980	S.RES ERJ2GEJ 101 X (100)	B	98.9/64
R215	7030010040	S.RES ERJ2GEJ-JPW	B	100.9/62
R216	7410001140	S.ARR EXB28V104JX	T	17.3/52.4
R217	7410001140	S.ARR EXB28V104JX	T	38.6/56
R218	7030005090	S.RES ERJ2GEJ 104 X (100K)	B	61.4/138.5
R220	7410001140	S.ARR EXB28V104JX	T	15.2/50.7
R222	7410001140	S.ARR EXB28V104JX	T	36.1/56
R223	7030005050	S.RES ERJ2GEJ 103 X (10K)	B	61.4/137.6
R224	7410001150	S.ARR EXB28V471JX	T	30.4/53.1
R225	7030005090	S.RES ERJ2GEJ 104 X (100K)	B	61.4/139.4
R226	7030005110	S.RES ERJ2GEJ 224 X (220K)	B	39.9/72.7
R227	7410001150	S.ARR EXB28V471JX	T	42.9/28.9
R230	7410001150	S.ARR EXB28V471JX	T	28.6/50.9
R231	7030005000	S.RES ERJ2GEJ 471 X (470)	B	58.2/139.4
R232	7410001150	S.ARR EXB28V471JX	T	25.9/49.4
R233	7030004980	S.RES ERJ2GEJ 101 X (100)	B	58.2/135.8
R234	7410001150	S.ARR EXB28V471JX	T	42.5/25.7
R235	7410001150	S.ARR EXB28V471JX	T	24.2/47.6
R236	7030005090	S.RES ERJ2GEJ 104 X (100K)	B	132.4/82.7
R237	7030005530	S.RES ERJ2GEJ 100 X (10)	B	49.4/138.8
R238	7410001150	S.ARR EXB28V471JX	T	45.7/28.9
R239	7410001150	S.ARR EXB28V471JX	T	22.4/45.8
R240	7030004980	S.RES ERJ2GEJ 101 X (100)	B	134.7/86.7
R241	7030004990	S.RES ERJ2GEJ 221 X (220)	B	49.4/134.3
R242	7030009320	S.RES ERJ2GEJ 4R7 X (4.7)	B	48.4/138.8
R243	7030005090	S.RES ERJ2GEJ 104 X (100K)	B	47.4/138.8
R244	7410001150	S.ARR EXB28V471JX	T	39.7/25.8
R245	7410001150	S.ARR EXB28V471JX	T	20.2/42.4
R246	7030005310	S.RES ERJ2GEJ 124 X (120K)	B	45.6/136.6
R247	7030005720	S.RES ERJ2GEJ 563 X (56K)	B	48.4/140.4
R249	7030008010	S.RES ERJ2GEJ 123 X (12K)	B	135.6/88.4
R250	7030004980	S.RES ERJ2GEJ 101 X (100)	B	133.8/90.1
R251	7030006610	S.RES ERJ2GEJ 394 X (390K)	B	49.4/142.5
R252	7030010040	S.RES ERJ2GEJ-JPW	B	132/86.7
R253	7030004970	S.RES ERJ2GEJ 470 X (47)	B	136.5/90.1
R255	7030005040	S.RES ERJ2GEJ 472 X (4.7K)	B	52.4/142.5
R256	7030005040	S.RES ERJ2GEJ 472 X (4.7K)	B	137.7/90.1
R257	7410001140	S.ARR EXB28V104JX	T	14.5/45.7
R259	7030005170	S.RES ERJ2GEJ 474 X (470K)	B	57.1/142.5
R260	7030007290	S.RES ERJ2GEJ 222 X (2.2K)	B	108.8/25.3
R261	7030005050	S.RES ERJ2GEJ 103 X (10K)	T	52.5/25.2
R262	7030005090	S.RES ERJ2GEJ 104 X (100K)	T	51.9/22.8
R263	7410001140	S.ARR EXB28V104JX	T	46.2/20
R264	7410001140	S.ARR EXB28V104JX	T	50.2/24
R265	7030010040	S.RES ERJ2GEJ-JPW	B	87.1/43.5
R267	7410001140	S.ARR EXB28V104JX	T	15/42.5
R268	7410001150	S.ARR EXB28V471JX	T	45.7/31.8
R269	7030004980	S.RES ERJ2GEJ 101 X (100)	B	143.2/94.7
R270	7030005050	S.RES ERJ2GEJ 103 X (10K)	B	36/136.6
R271	7030005090	S.RES ERJ2GEJ 104 X (100K)	T	23.8/26.7
R272	7410001150	S.ARR EXB28V471JX	T	17.9/32.3
R273	7410001150	S.ARR EXB28V471JX	T	17.9/35.1
R274	7030005090	S.RES ERJ2GEJ 104 X (100K)	B	36/137.5
R275	7030005060	S.RES ERJ2GEJ 333 X (33K)	T	93.1/55.7
R276	7030010040	S.RES ERJ2GEJ-JPW	B	87.1/44.4
R277	7030004980	S.RES ERJ2GEJ 101 X (100)	T	145/126
R278	7030005090	S.RES ERJ2GEJ 104 X (100K)	T	13.9/65.6
R279	7030007290	S.RES ERJ2GEJ 222 X (2.2K)	T	102.4/90.1
R280	7030004990	S.RES ERJ2GEJ 221 X (220)	T	141.3/127.7
R281	7410001150	S.ARR EXB28V471JX	T	21.3/31.8
R282	7030005090	S.RES ERJ2GEJ 104 X (100K)	T	37.8/20.3
R283	7030005100	S.RES ERJ2GEJ 154 X (150K)	T	144/124.4
R285	7030005050	S.RES ERJ2GEJ 103 X (10K)	T	101.6/79.5
R286	7030005080	S.RES ERJ2GEJ 823 X (82K)	B	40.8/72.7
R287	7410001140	S.ARR EXB28V104JX	T	49.7/27.7
R288	7030007340	S.RES ERJ2GEJ 153 X (15K)	T	139.5/122.5
R289	7030006070	S.RES ERJ12VJ101U (100)	B	86.9/117.5

[MAIN UNIT]

REF NO.	PARTS NO.	DESCRIPTION	M.	H/V LOCATION
R290	7030005050	S.RES ERJ2GEJ 103 X (10K)	T	138.6/122.5
R291	7030005040	S.RES ERJ2GEJ 472 X (4.7K)	T	137.6/127.7
R292	7030005050	S.RES ERJ2GEJ 103 X (10K)	T	144/126
R293	7030004980	S.RES ERJ2GEJ 101 X (100)	B	136.5/83.3
R294	7030004980	S.RES ERJ2GEJ 101 X (100)	B	136.5/85
R295	7030005090	S.RES ERJ2GEJ 104 X (100K)	T	137.6/122.5
R296	7030000440	S.RES MCR10EZHJ 3.3K (332)	T	118.4/79.6
R297	7030000440	S.RES MCR10EZHJ 3.3K (332)	T	120.2/79.6
R298	7030000440	S.RES MCR10EZHJ 3.3K (332)	T	116.6/79.6
R299	7030004980	S.RES ERJ2GEJ 101 X (100)	B	29.1/19.4
R300	7030005530	S.RES ERJ2GEJ 100 X (10)	T	47.6/73.1
R301	7030008300	S.RES ERJ2GEJ 184 X (180K)	B	85.6/105.6
R302	7030005590	S.RES ERJ2GEJ 680 X (68)	B	135.6/85
R303	7410001150	S.ARR EXB28V471JX	T	47.7/68.4
R304	7030005050	S.RES ERJ2GEJ 103 X (10K)	B	84.3/130
R306	7520000261	S.POS PRF18B471QB5RB	B	84.4/104.4
R308	7030005060	S.RES ERJ2GEJ 333 X (33K)	T	144/127.7
	7030005060	S.RES ERJ2GEJ 333 X (33K)	[USA-01]	
	7030005070	S.RES ERJ2GEJ 683 X (68K)	[EXP-01]	
	7030005070	S.RES ERJ2GEJ 683 X (68K)	[EUR-01]	
	7030005070	S.RES ERJ2GEJ 683 X (68K)	[DPM-01]	
R309	7030005040	S.RES ERJ2GEJ 472 X (4.7K)	T	102.2/75.7
R310	7030005030	S.RES ERJ2GEJ 152 X (1.5K)	T	143.3/120.2
R311	7030008410	S.RES ERJ2GEJ 392 X (3.9K)	T	145/122.5
R312	7030005050	S.RES ERJ2GEJ 103 X (10K)	T	146.8/120.2
R313	7030005050	S.RES ERJ2GEJ 103 X (10K)	T	103.5/77.8
R314	7030007280	S.RES ERJ2GEJ 331 X (330)	T	146/124.4
R315	7030005700	S.RES ERJ2GEJ 274 X (270K)	B	86/128.9
R316	7030005050	S.RES ERJ2GEJ 103 X (10K)	B	11.2/128.2
R317	7030005010	S.RES ERJ2GEJ 681 X (680)	B	138.5/94.7
R318	7030003260	S.RES ERJ3GEYJ 330 V (33)	B	140.2/90.1
R320	7030005090	S.RES ERJ2GEJ 104 X (100K)	T	15/124.1
R321	7030003370	S.RES ERJ3GEYJ 271 V (270)	B	119.6/141.7
R322	7030005600	S.RES ERJ2GEJ 273 X (27K)	B	121.5/143.4
R324	7030005050	S.RES ERJ2GEJ 103 X (10K)	B	31.3/12
R325	7030005120	S.RES ERJ2GEJ 102 X (1K)	B	32.3/12
R326	7030005240	S.RES ERJ2GEJ 473 X (47K)	T	13.2/125.7
R327	7030000260	S.RES MCR10EZHJ 100 (101)	B	119.7/132.8
R328	7030000280	S.RES MCR10EZHJ 150 (151)	B	139.3/144.3
R331	7030004980	S.RES ERJ2GEJ 101 X (100)	T	12/120
R332	7030003370	S.RES ERJ3GEYJ 271 V (270)	B	139.5/136
R333	7030003600	S.RES ERJ2GEJ 273 X (27K)	B	137.7/131.9
R334	7030005651	S.RES ERA3YKD 304V (300K)	T	57.8/30.5
R335	7030005871	S.RES ERA3YKD 104V (100K)	T	55.9/29.7
R336	7030005110	S.RES ERJ2GEJ 224 X (220K)	T	12/120.9
R337	7030005110	S.RES ERJ2GEJ 224 X (220K)	T	13.2/120.6
R339	7030005090	S.RES ERJ2GEJ 104 X (100K)	T	12/125.3
R341	7030005050	S.RES ERJ2GEJ 103 X (10K)	B	33.3/12
R342	7030005090	S.RES ERJ2GEJ 104 X (100K)	B	45.3/56.9
R346	7410001150	S.ARR EXB28V471JX	T	43.5/73.8
R347	7030005040	S.RES ERJ2GEJ 472 X (4.7K)	T	9.8/132.9
R348	7030000620	S.RES MCR10EZHJ 100 K (104)	B	147.2/150.9
R349	7030000620	S.RES MCR10EZHJ 100 K (104)	B	26/149.7
R350	7030003560	S.RES ERJ3GEYJ 103 V (10K)	B	6.4/131
R352	7030005040	S.RES ERJ2GEJ 472 X (4.7K)	T	10.7/125.5
R353	7030005240	S.RES ERJ2GEJ 473 X (47K)	B	55.8/56.9
R354	7030005700	S.RES ERJ2GEJ 274 X (270K)	T	123.3/103
R355	7030005090	S.RES ERJ2GEJ 104 X (100K)	T	127.4/102.2
R356	7030005090	S.RES ERJ2GEJ 104 X (100K)	T	9.8/134.5
R357	7030003560	S.RES ERJ3GEYJ 103 V (10K)	B	10.1/150.2
R362	7540000290	ABS ERZV10D220		
R364	7030005110	S.RES ERJ2GEJ 224 X (220K)	T	65.1/71.2
R365	7030005050	S.RES ERJ2GEJ 103 X (10K)	T	7.4/120.7
R366	7030007290	S.RES ERJ2GEJ 222 X (2.2K)	T	6.2/122.7
R367	7030004980	S.RES ERJ2GEJ 101 X (100)	T	9.7/117.3
R368	7030008300	S.RES ERJ2GEJ 184 X (180K)	T	8.5/117.8
R369	7030005230	S.RES ERJ2GEJ 334 X (330K)	T	9.7/118.2
R370	7030008280	S.RES ERJ2GEJ 271 X (270)	T	6.1/120.7
R371	7030010040	S.RES ERJ2GEJ-JPW	T	5/117.3
R372	7030005000	S.RES ERJ2GEJ 471 X (470)	T	115.3/15.8
R373	7030005050	S.RES ERJ2GEJ 103 X (10K)	T	115.3/14
R374	7030000140	S.RES MCR10EZHJ 10 (100)	T	111.2/12.3
R375	7030010040	S.RES ERJ2GEJ-JPW	T	100.1/16.3
R376	7030004980	S.RES ERJ2GEJ 101 X (100)	B	62.3/122.2
R378	7030005210	S.RES ERJ2GEJ 822 X (8.2K)	B	63.2/126.1
R379	7030005210	S.RES ERJ2GEJ 822 X (8.2K)	B	59.6/126.1
R380	7030007260	S.RES ERJ2GEJ 330 X (33)	B	57.8/123.7
R				

[MAIN UNIT]

REF NO.	PARTS NO.	DESCRIPTION	M.	H/V LOCATION
R469	7030005090	S.RES ERJ2GEJ 104 X (100K)	B	32.6/44.6
R470	7030005090	S.RES ERJ2GEJ 104 X (100K)	T	10.9/20.2
R471	7030005090	S.RES ERJ2GEJ 104 X (100K)	B	47.7/44.2
R472	7030005240	S.RES ERJ2GEJ 473 X (47K)	B	4.8/36.1
R473	7030005090	S.RES ERJ2GEJ 104 X (100K)	B	46.2/44.6
R474	7030005530	S.RES ERJ2GEJ 100 X (10)	B	15.5/55.3
R475	7030005000	S.RES ERJ2GEJ 471 X (470)	B	9/56.2
R476	7030005090	S.RES ERJ2GEJ 104 X (100K)	B	15/53.5
R477	7030005080	S.RES ERJ2GEJ 823 X (82K)	B	15/52.6
R478	7030005050	S.RES ERJ2GEJ 103 X (10K)	B	9.1/54.7
R479	7030005110	S.RES ERJ2GEJ 224 X (220K)	T	64.2/69.6
R480	7030005050	S.RES ERJ2GEJ 103 X (10K)	B	15.6/61.5
R481	7030005050	S.RES ERJ2GEJ 103 X (10K)	B	16.5/59.9
R482	7410001150	S.ARR EXB28V471JX	T	19.6/45.1
R483	7030005090	S.RES ERJ2GEJ 104 X (100K)	T	31.2/56.5
R484	7030005090	S.RES ERJ2GEJ 104 X (100K)	T	28.8/50.9
R485	7410001150	S.ARR EXB28V471JX	B	67.3/96.9
R486	7410001150	S.ARR EXB28V471JX	T	63.9/107
R487	7410001150	S.ARR EXB28V471JX	T	73/106.9
R488	7030005000	S.RES ERJ2GEJ 471 X (470)	T	9.5/54.9
R489	7030004980	S.RES ERJ2GEJ 101 X (100)	B	24.1/58.7
R490	7030008290	S.RES ERJ2GEJ 183 X (18K)	B	28.2/58.4
R491	7030004980	S.RES ERJ2GEJ 101 X (100)	B	26.1/51.2
R492	7030005240	S.RES ERJ2GEJ 473 X (47K)	B	29.8/58.8
R493	7030010040	S.RES ERJ2GEJ-JPW	T	11.3/19
R494	7030005000	S.RES ERJ2GEJ 471 X (470)	T	73.3/99
R495	7030008270	S.RES RR0510P-104-D (100K)	T	54.9/55.3
R496	7030006020	S.RES RR0510P-682-D (6.8K)	T	52.7/56.2
R497	7030008250	S.RES RR0510P-562-D (5.6K)	T	52.7/55.3
R498	7030005600	S.RES ERJ2GEJ 273 X (27K)	B	61.4/103.1
R499	7030004980	S.RES ERJ2GEJ 101 X (100)	T	24.4/57
R500	7030005600	S.RES ERJ2GEJ 273 X (27K)	T	21.2/57.5
R501	7030005220	S.RES ERJ2GEJ 223 X (22K)	T	22.8/53.8
R502	7030005090	S.RES ERJ2GEJ 104 X (100K)	T	28/55
R503	7030007350	S.RES ERJ2GEJ 393 X (39K)	T	55.6/58.9
R504	7030011920	S.RES RR0510P-561-D (56K)	T	52.7/54.4
R505	7030010040	S.RES ERJ2GEJ-JPW	T	113.4/18.3
R506	7030005110	S.RES ERJ2GEJ 224 X (220K)	T	113.4/19.3
R507	7030005090	S.RES ERJ2GEJ 104 X (100K)	T	115/19.3
R508	7030010040	S.RES ERJ2GEJ-JPW	B	93.7/42.6
R509	7030005050	S.RES ERJ2GEJ 103 X (10K)	B	33.3/15.2
R510	7030007350	S.RES ERJ2GEJ 393 X (39K)	B	29/14.1
R511	7030005050	S.RES ERJ2GEJ 103 X (10K)	B	29.1/18.5
R512	7030005050	S.RES ERJ2GEJ 103 X (10K)	B	30.8/18.5
R513	7030007280	S.RES ERJ2GEJ 331 X (330)	B	72.6/91
R530	7030005240	S.RES ERJ2GEJ 473 X (47K)	T	62.5/66.3
R532	7030005000	S.RES ERJ2GEJ 471 X (470)	B	45.1/37.1
R533	7030005090	S.RES ERJ2GEJ 104 X (100K)	T	57.2/18.4
R534	7030005600	S.RES ERJ2GEJ 273 X (27K)	B	45.3/58.6
R535	7030004980	S.RES ERJ2GEJ 101 X (100)	B	56.7/56.9
R536	7030005600	S.RES ERJ2GEJ 273 X (27K)	B	55.8/58.6
R537	7030010040	S.RES ERJ2GEJ-JPW	B	41.6/41.2
R539	7030005110	S.RES ERJ2GEJ 224 X (220K)	T	64.2/71.2
R540	7030005090	S.RES ERJ2GEJ 104 X (100K)	T	90.6/17.9
R541	7030005220	S.RES ERJ2GEJ 223 X (22K)	T	28.9/55
R542	7030005120	S.RES ERJ2GEJ 102 X (1K)	T	70.4/65.1
R545	7030010040	S.RES ERJ2GEJ-JPW	T	61.2/98.7
R546	7030010040	S.RES ERJ2GEJ-JPW	B	61.2/99.6
R547	7030010040	S.RES ERJ2GEJ-JPW	T	69.7/99.1
R548	7030009140	S.RES ERJ2GEJ 272 X (2.7K)	B	38.7/139
R549	7030001070	S.RES MCR50JZHJ 33 (330)	T	87.6/30.2
R550	7030001070	S.RES MCR50JZHJ 33 (330)	T	87.6/33.3
C1	4030017420	S.CER C1005 CH 1H 470J-T	B	120.7/39
C2	4030017420	S.CER C1005 CH 1H 470J-T	B	22.9/78.1
C3	4030016930	S.CER C1005 JB 1A 104K-T	B	130.8/50.2
C4	4030017420	S.CER C1005 CH 1H 470J-T	B	121.9/37.1
C5	4030017420	S.CER C1005 CH 1H 470J-T	B	21.7/77.1
C6	4030016930	S.CER C1005 JB 1A 104K-T	B	52.4/77.9
C7	4030017420	S.CER C1005 CH 1H 470J-T	B	122.8/37.1
C8	4030017420	S.CER C1005 CH 1H 470J-T	B	21.7/75.5
C9	4030017460	S.CER C1005 JB 1H 102K-T	T	17.6/59
C10	4030016930	S.CER C1005 JB 1A 104K-T	B	55.7/77.9
C11	4030016930	S.CER C1005 JB 1A 104K-T	B	123.7/37.1
C12	4030016930	S.CER C1005 JB 1A 104K-T	B	22.1/74.3
C13	4030016930	S.CER C1005 JB 1A 104K-T	B	55.6/80.7
C14	4030017460	S.CER C1005 JB 1H 102K-T	T	16.1/59.9
C15	4030016930	S.CER C1005 JB 1A 104K-T	T	62.4/67.5
C17	4030016930	S.CER C1005 JB 1A 104K-T	B	115.5/40.6
C18	4030017430	S.CER C1005 CH 1H 101J-T	T	62.4/71.2
C19	4030016930	S.CER C1005 JB 1A 104K-T	B	22.9/80.3
C20	4550006250	S.TAN TEESVA 1A 106M8R	B	115.3/37.5
C21	4550006250	S.TAN TEESVA 1A 106M8R	B	21.3/80.5
C22	4030016930	S.CER C1005 JB 1A 104K-T	B	50/77.9
C23	4030016930	S.CER C1005 JB 1A 104K-T	T	57.8/52.6
C24	4030016930	S.CER C1005 JB 1A 104K-T	B	50.3/81.1
C25	4030016930	S.CER C1005 JB 1A 104K-T	B	54.4/81.1
C26	4030017460	S.CER C1005 JB 1H 102K-T	B	117.8/39.2
C27	4030017460	S.CER C1005 JB 1H 102K-T	B	23.8/80.3
C28	4030016930	S.CER C1005 JB 1A 104K-T	B	53.3/77.9
C30	4030017460	S.CER C1005 JB 1H 102K-T	T	59.8/67
C31	4030016930	S.CER C1005 JB 1A 104K-T	T	60.5/53
C32	4030017590	S.CER C1005 CH 1H 070C-T	B	38.4/79.1
C33	4030016930	S.CER C1005 JB 1A 104K-T	T	58.9/67
C34	4030017570	S.CER C1005 CH 1H 040B-T	B	37.2/78.7
C35	4030016930	S.CER C1005 JB 1A 104K-T	B	35.8/75.7
C36	4030017500	S.CER C1005 CH 1H 560J-T	B	37.2/79.6
C37	4030016930	S.CER C1005 JB 1A 104K-T	B	48.4/79.8
C38	4030016930	S.CER C1005 JB 1A 104K-T	B	69.8/78.2
C39	4030017360	S.CER C1005 CH 1H 030B-T	B	71.4/77.3
C40	4030017690	S.CER C1005 CH 1H 121J-T	B	68.2/76.4
C41	4030018860	S.CER C1005 JB 0J 105K-T	B	31/58.2
C42	4030017690	S.CER C1005 CH 1H 121J-T	B	66.4/78.2
C43	4030016930	S.CER C1005 JB 1A 104K-T	B	55.6/49

[MAIN UNIT]

REF NO.	PARTS NO.	DESCRIPTION	M.	H/V LOCATION
C44	4030018860	S.CER C1005 JB 0J 105K-T	B	35.7/56.4
C45	4030016950	S.CER C1005 JB 1A 473K-T	B	34.5/55.2
C47	4030017460	S.CER C1005 JB 1H 102K-T	B	64.6/77.3
C48	4030016930	S.CER C1005 JB 1A 104K-T	T	54.3/54.4
C49	4030018860	S.CER C1005 JB 0J 105K-T	B	15.6/58.3
C50	4030016930	S.CER C1005 JB 1A 104K-T	B	130.8/48.4
C51	4030017620	S.CER C1005 CH 1H 100C-T	B	125.1/45.6
C52	4030017420	S.CER C1005 CH 1H 470J-T	B	120.6/48.8
C53	4030017420	S.CER C1005 CH 1H 470J-T	B	32.7/78.4
C54	4030017660	S.CER C1005 CH 1H 330J-T	B	32.7/77.3
C56	4030016950	S.CER C1005 JB 1A 473K-T	B	31.9/59.1
C59	4030017430	S.CER C1005 CH 1H 101J-T	B	32.7/75.5
C60	4030017620	S.CER C1005 CH 1H 100C-T	B	32.3/72.7
C61	4030018900	S.CER C1005 JB 0J 474K-T	B	18/63.8
C62	4030016930	S.CER C1005 JB 1A 104K-T	B	33.6/55.2
C63	4030016930	S.CER C1005 JB 1A 104K-T	T	55.6/62.1
C64	4030017460	S.CER C1005 JB 1H 102K-T	B	33.2/104.3
C66	4030017430	S.CER C1005 CH 1H 101J-T	B	123.5/48.4
C67	4030017460	S.CER C1005 JB 1H 102K-T	B	67.5/87.7
C69	4030016930	S.CER C1005 JB 1A 104K-T	B	29.8/63
C70	4030017460	S.CER C1005 JB 1H 102K-T	B	64.3/79.4
C71	4030016930	S.CER C1005 JB 1A 104K-T	B	57.6/43.3
C72	4030018910	S.CER C1608 JB 0J 475K-T	B	29.3/61.9
C73	4030017460	S.CER C1005 JB 1H 102K-T	B	93.7/46.2
C74	4030017780	S.CER C1005 JB 1H 472K-T	B	93.7/40.7
C75	4030017460	S.CER C1005 JB 1H 102K-T	B	39.6/106.1
C76	4030017780	S.CER C1005 JB 1H 472K-T	B	29.9/98.3
C77	4030016930	S.CER C1005 JB 1A 104K-T	T	53.9/57.7
C78	4030017460	S.CER C1005 JB 1H 102K-T	B	118.7/48.8
C79	4030017460	S.CER C1005 JB 1H 102K-T	B	34.3/79.5
C80	4030017380	S.CER C1005 CH 1H 050B-T	B	102.4/44.5
C81	4030017380	S.CER C1005 CH 1H 050B-T	B	44/101.1
C82	4550006250	S.TAN TEESVA 1A 106M8R	B	61.1/79.2
C83	4030017460	S.CER C1005 JB 1H 102K-T	B	71.7/86.7
C84	4030017420	S.CER C1005 CH 1H 470J-T	B	74.7/81.1
C85	4030017590	S.CER C1005 CH 1H 070C-T	B	56/43.6
C86	4030016930	S.CER C1005 JB 1A 104K-T	B	51.7/47.1
C87	4030018910	S.CER C1608 JB 0J 475K-T	B	54.3/48.4
C88	4030017780	S.CER C1005 JB 1H 472K-T	B	92.1/40.7
C89	4030017780	S.CER C1005 JB 1H 472K-T	B	28.3/99.3
C90	4030017680	S.CER C1005 CH 1H 820J-T	B	69.1/86.7
C91	4030016930	S.CER C1005 JB 1A 104K-T	T	60.7/66.3
C92	4030016790	S.CER C1005 JB 1E 103K-T	B	72.7/88
C93	4030017460	S.CER C1005 JB 1H 102K-T	B	70.5/87.2
C94	4030017350	S.CER C1005 CH 1H 020B-T	B	103.2/47.6
C96	4030018910	S.CER C1608 JB 0J 475K-T	B	49.2/48.9
C97	4030016930	S.CER C1005 JB 1A 104K-T	B	57.4/50.6
C98	4030017460	S.CER C1005 JB 1H 102K-T	B	36.4/105.2
C99	4030017460	S.CER C1005 JB 1H 102K-T	B	40.8/71.1
C100	4030017460	S.CER C1005 JB 1H 102K-T	B	84.7/48
C101	4030017620	S.CER C1005 CH 1H 100C-T	B	37.7/63.2
C102	4550007650	S.TAN F931V105MAABMA	B	88.7/41
C103	4550007650	S.TAN F931V105MAABMA	B	26.2/100.3
C104	4030016930	S.CER C1005 JB 1A 104K-T	B	39.9/74.3
C105	4030017580	S.CER C1005 CH 1H 060C-T	B	103.2/46.7
C106	4030017350	S.CER C1005 CH 1H 020B-T	B	47/102.2
C107	4030017590	S.CER C1005 CH 1H 070C-T	B	72.3/90
C108	4030017460	S.CER C1005 JB 1H 102K-T	B	87.1/48
C109	4030017380	S.CER C1005 CH 1H 050B-T	B	101.9/47.2
C110	4030017360	S.CER C1005 CH 1H 030B-T	B	46.5/103.5
C111	4030016790	S.CER C1005 JB 1E 103K-T	B	71/93.8
C112	4550007650	S.TAN F931V105MAABMA	B	83.6/41
C113	4550007650	S.TAN F931V105MAABMA	B	28.3/105.6
C114	4030017580	S.CER C1005 CH 1H 060C-T	B	103.2/48.5
C115	4030017350	S.CER C1005 CH 1H 020B-T	B	47/104.9
C116	4030017460	S.CER C1005 JB 1H 102K-T	B	71/91
C117	4030016790	S.CER C1005 JB 1E 103K-T	B	73.5/90.2
C118	4030016790	S.CER C1005 JB 1E 103K-T	B	71/92
C119	4030017350	S.CER C1005 CH 1H 020B-T	B	103.2/49.4
C121	4030016790	S.CER C1005 JB 1E 103K-T	B	71/94.8
C122	4030016790	S.CER C1005 JB 1E 103K-T	B	69.1/90.1
C123	4030016930	S.CER C1005 JB 1A 104K-T	B	67.4/98.3
C124	4030016930	S.CER C1005 JB 1A 104K-T	B	48.5/50.5
C125	4030016790	S.CER C1005 JB 1E 103K-T	B	98.1/42.6
C126	4030016790	S.CER C1005 JB 1E 103K-T	B	57.2/35.1
C127	4030016790	S.CER C1005 JB 1E 103K-T	T	32.4/108.3
C133	4030017590	S.CER C1005 CH 1H 070C-T	B	59.6/92

[MAIN UNIT]

REF NO.	PARTS NO.	DESCRIPTION	M.	H/V LOCATION
C165	4030016930	S.CER C1005 JB 1A 104K-T	B	81.8/66.4
C166	4030017460	S.CER C1005 JB 1H 102K-T	B	82.3/58.2
C167	4030017460	S.CER C1005 JB 1H 102K-T	B	81.8/67.3
C168	4030017400	S.CER C1005 CH 1H 220J-T	B	29.9/122.2
C169	4030018070	S.CER C1005 CH 1H 300J-T	B	30.8/122.2
C170	4030018070	S.CER C1005 CH 1H 300J-T	B	28.7/114.6
C171	4030017390	S.CER C1005 CH 1H 180J-T	B	28.7/113.7
C172	4030017510	S.CER C1005 CH 1H 680J-T	B	85.8/63.9
C173	4030017550	S.CER C1005 CH 1H 1R5B-T	B	93/66.4
C174	4030017420	S.CER C1005 CH 1H 470J-T	B	84.4/54.1
C175	4030017460	S.CER C1005 JB 1H 102K-T	T	93.1/53.9
C176	4030018860	S.CER C1005 JB 0J 105K-T	B	90.9/57.7
C177	4030017600	S.CER C1005 CH 1H 080C-T	B	36.7/123.3
C178	4030017600	S.CER C1005 CH 1H 080C-T	B	37.6/111.1
C179	4030017420	S.CER C1005 CH 1H 470J-T	T	14.9/129.1
C180	4030017640	S.CER C1005 CH 1H 150J-T	B	91.7/65
C181	4030017400	S.CER C1005 CH 1H 220J-T	B	83.4/54.1
C182	4030016790	S.CER C1005 JB 1E 103K-T	B	63.1/104.4
C183	4030017420	S.CER C1005 CH 1H 470J-T	T	14.9/131.3
C184	4030017670	S.CER C1005 CH 1H 390J-T	B	37.9/124.9
C185	4030018010	S.CER C1005 CH 1H 360J-T	B	37.6/115.6
C186	4030017420	S.CER C1005 CH 1H 470J-T	T	93.1/57.7
C187	4030017420	S.CER C1005 CH 1H 470J-T	T	95.3/67.6
C188	4030017650	S.CER C1005 CH 1H 270J-T	B	84.9/63.9
C189	4030017620	S.CER C1005 CH 1H 100C-T	B	93.1/51.4
C190	4030017550	S.CER C1005 CH 1H 1R5B-T	B	93.1/56.8
C191	4030017660	S.CER C1005 CH 1H 330J-T	B	93/65.5
C192	4030017670	S.CER C1005 CH 1H 390J-T	B	93.1/55.9
C193	4030017460	S.CER C1005 JB 1H 102K-T	B	61.4/107.1
C194	4030017660	S.CER C1005 CH 1H 330J-T	B	37.9/123.1
C195	4030017670	S.CER C1005 CH 1H 390J-T	B	40.3/120.7
C196	4030018010	S.CER C1005 CH 1H 360J-T	B	37.6/113.8
C197	4030017670	S.CER C1005 CH 1H 390J-T	B	41.7/112.2
C198	4030016790	S.CER C1005 JB 1E 103K-T	B	60.5/107.1
C199	4030017460	S.CER C1005 JB 1H 102K-T	T	95.3/63.1
C200	4030017650	S.CER C1005 CH 1H 270J-T	B	93/63.7
C201	4030017660	S.CER C1005 CH 1H 330J-T	B	96/62
C202	4030017670	S.CER C1005 CH 1H 390J-T	B	93.1/54.1
C203	4030017420	S.CER C1005 CH 1H 470J-T	B	97.2/52
C204	4550006250	S.TAN TEESVA 1A 106M8R	T	81.6/17
C205	4550006250	S.TAN TEESVA 1A 106M8R	T	85.1/17
C206	4550006250	S.TAN TEESVA 1A 106M8R	T	88.5/17
C208	4030018860	S.CER C1005 JB 0J 105K-T	T	80/17
C209	4030018860	S.CER C1005 JB 0J 105K-T	T	83.5/17
C210	4030018860	S.CER C1005 JB 0J 105K-T	T	86.9/17
C211	4030016930	S.CER C1005 JB 1A 104K-T	B	38.5/120.7
C212	4030016790	S.CER C1005 JB 1E 103K-T	B	39.9/112.2
C213	4030017650	S.CER C1005 CH 1H 270J-T	B	68.5/106.1
C214	4030017460	S.CER C1005 JB 1H 102K-T	B	66.8/107
C215	4030017540	S.CER C1005 CH 1H R75B-T	B	42.8/118.5
C216	4030017540	S.CER C1005 CH 1H R75B-T	B	42.8/116.9
C217	4030017460	S.CER C1005 JB 1H 102K-T	B	39.4/120.7
C218	4030017460	S.CER C1005 JB 1H 102K-T	B	40.8/112.2
C219	4030016790	S.CER C1005 JB 1E 103K-T	B	94.2/62
C220	4030017530	S.CER C1005 CH 1H 0R5B-T	B	98.5/59.6
C221	4030016790	S.CER C1005 JB 1E 103K-T	B	95.4/52
C222	4030017530	S.CER C1005 CH 1H 0R5B-T	B	99.4/56.6
C224	4030017460	S.CER C1005 JB 1H 102K-T	B	95.1/62
C225	4030017460	S.CER C1005 JB 1H 102K-T	B	96.3/52
C228	4030018860	S.CER C1005 JB 0J 105K-T	T	78.6/24.6
C229	4030018860	S.CER C1005 JB 0J 105K-T	T	83.2/24.9
C230	4030018860	S.CER C1005 JB 0J 105K-T	T	86.8/24
C231	4550005980	S.TAN TEESVA 1A 475M8R	T	80.3/25.8
C232	4550005980	S.TAN TEESVA 1A 475M8R	T	84.8/26.2
C233	4550005980	S.TAN TEESVA 1A 475M8R	T	88.5/25.6
C235	4030017030	S.CER C1005 JB 1A 273K-T	T	41/55
C236	4030017730	S.CER C1005 JB 1H 471K-T	B	100.6/55
C237	4030017460	S.CER C1005 JB 1H 102K-T	B	100.6/60.4
C238	4030017730	S.CER C1005 JB 1H 471K-T	B	44.9/113.8
C239	4030017460	S.CER C1005 JB 1H 102K-T	B	44.9/119.2
C240	4510009550	S.ELE EEEFK1C100R	T	95.1/22.3
C241	4030017350	S.CER C1005 CH 1H 020B-T	B	68.3/120.9
C242	4030016790	S.CER C1005 JB 1E 103K-T	B	68.7/111.2
C243	4030017460	S.CER C1005 JB 1H 102K-T	B	70.3/106.1
C244	4030016790	S.CER C1005 JB 1E 103K-T	B	70.3/107
C245	4030017460	S.CER C1005 JB 1H 102K-T	T	94.8/60.2
C246	4030017620	S.CER C1005 CH 1H 100C-T	B	46.9/114.7
C247	4030017460	S.CER C1005 JB 1H 102K-T	B	42.6/112.2
C248	4030017460	S.CER C1005 JB 1H 102K-T	B	36/117.8
C249	4030017420	S.CER C1005 CH 1H 470J-T	B	48/112.2
C250	4030017590	S.CER C1005 CH 1H 070C-T	B	103.7/58.7
C251	4030017620	S.CER C1005 CH 1H 100C-T	B	102.6/55.9
C252	4030017460	S.CER C1005 JB 1H 102K-T	B	99.2/51.3
C253	4030017590	S.CER C1005 CH 1H 070C-T	B	48/117.4
C254	4030017460	S.CER C1005 JB 1H 102K-T	B	103.7/53
C255	4030016930	S.CER C1005 JB 1A 104K-T	T	42.1/50.6
C256	4030017640	S.CER C1005 CH 1H 150J-T	T	43.1/55
C257	4030016790	S.CER C1005 JB 1E 103K-T	T	36.5/58.8
C258	4030017390	S.CER C1005 CH 1H 180J-T	B	59.6/117.8
C259	4030017580	S.CER C1005 CH 1H 060C-T	T	48.5/46.4
C260	4030017460	S.CER C1005 JB 1H 102K-T	B	46.5/107.5
C261	4030017460	S.CER C1005 JB 1H 102K-T	B	47.7/110.3
C262	4030016930	S.CER C1005 JB 1A 104K-T	T	69.2/57.5
C263	4030017460	S.CER C1005 JB 1H 102K-T	B	60.5/126.1
C264	4030017460	S.CER C1005 JB 1H 102K-T	B	101.9/48.9
C265	4030017460	S.CER C1005 JB 1H 102K-T	B	43.5/120.7
C266	4030018900	S.CER C1005 JB 0J 474K-T	T	43.7/45.6
C267	4030017660	S.CER C1005 CH 1H 330J-T	B	59.6/119.3
C268	4030017460	S.CER C1005 JB 1H 102K-T	B	62.3/126.1
C269	4550006780	S.TAN TEESVB2 0J 476M8R	T	72.2/60.8
C270	4030016930	S.CER C1005 JB 1A 104K-T	T	40.5/49.7
C271	4030017610	S.CER C1005 CH 1H 090C-T	B	70.7/137.8
C272	4030017630	S.CER C1005 CH 1H 120J-T	T	47.3/60.1
C274	4030017460	S.CER C1005 JB 1H 102K-T	B	44.4/120.7
C275	4030017620	S.CER C1005 CH 1H 100C-T	B	48/124.4

[MAIN UNIT]

REF NO.	PARTS NO.	DESCRIPTION	M.	H/V LOCATION
C276	4030017600	S.CER C1005 CH 1H 080C-T	B	71.9/139.9
C277	4030016790	S.CER C1005 JB 1E 103K-T	T	48.6/36.7
C279	4030017390	S.CER C1005 CH 1H 180J-T	T	59.6/120.9
C280	4030017460	S.CER C1005 JB 1H 102K-T	B	98.9/66.3
C281	4030017460	S.CER C1005 JB 1H 102K-T	B	100/62
C282	4030017630	S.CER C1005 CH 1H 120J-T	B	61.4/122.2
C283	4030017620	S.CER C1005 CH 1H 100C-T	B	103.7/65.9
C286	4030017570	S.CER C1005 CH 1H 040B-T	B	61.4/140.3
C287	4030017350	S.CER C1005 CH 1H 020B-T	B	58.2/138.5
C288	4030017570	S.CER C1005 CH 1H 040B-T	B	64.1/139.8
C289	4030017600	S.CER C1005 CH 1H 080C-T	B	71.9/135.7
C290	4030017600	S.CER C1005 CH 1H 080C-T	B	70.7/139.5
C291	4030017340	S.CER C1005 CH 1H 010B-T	B	102.4/66.6
C292	4030017460	S.CER C1005 JB 1H 102K-T	B	61.4/136.7
C293	4030017570	S.CER C1005 CH 1H 040B-T	B	44/100.2
C294	4030017360	S.CER C1005 CH 1H 030B-T	B	47.7/108.1
C295	4030017460	S.CER C1005 JB 1H 102K-T	B	61.4/135.8
C296	4030017200	S.CER GRM31BR32J102KY01L	B	98.7/132.7
C297	4030017580	S.CER C1005 CH 1H 060C-T	B	88.8/138.9
C298	4030017460	S.CER C1005 JB 1H 102K-T	B	132.9/86.7
C299	4030017460	S.CER C1005 JB 1H 102K-T	B	58.2/137.6
C300	4030017460	S.CER C1005 JB 1H 102K-T	B	58.2/134.9
C301	4030016790	S.CER C1005 JB 1E 103K-T	B	58.2/136.7
C302	4030017460	S.CER C1005 JB 1H 102K-T	B	54.2/139.8
C303	4030017400	S.CER C1005 CH 1H 220J-T	B	131.1/82.4
C304	4030017420	S.CER C1005 CH 1H 470J-T	B	133.8/86.7
C305	4030017420	S.CER C1005 CH 1H 470J-T	B	47.4/134.3
C306	4030017460	S.CER C1005 JB 1H 102K-T	B	48.4/134.3
C307	4030017460	S.CER C1005 JB 1H 102K-T	B	46.5/138.8
C309	4030016790	S.CER C1005 JB 1E 103K-T	B	134.7/88.4
C310	4030017630	S.CER C1005 CH 1H 120J-T	B	136.5/86.7
C311	4030016930	S.CER C1005 JB 1A 104K-T	B	46.5/140.4
C312	4030016930	S.CER C1005 JB 1A 104K-T	B	51.4/142.5
C313	4030016930	S.CER C1005 JB 1A 104K-T	B	47.4/140.4
C314	4030017460	S.CER C1005 JB 1H 102K-T	B	50.4/142.5
C315	4030017730	S.CER C1005 JB 1H 471K-T	B	136.5/92.3
C318	4030017460	S.CER C1005 JB 1H 102K-T	T	117.8/106.3
C319	4030017460	S.CER C1005 JB 1H 102K-T	[EUR-01] T	117.8/105.4
C320	4030017460	S.CER C1005 JB 1H 102K-T	[DPM-01] T	115.2/106.3
C321	4030017460	S.CER C1005 JB 1H 102K-T	[EUR-01] T	115.2/106.3
C322	4030017420	S.CER C1005 CH 1H 470J-T	[DPM-01] T	66/57.5
C323	4030017350	S.CER C1005 CH 1H 020B-T	T	62.3/52.9
C324	4030017630	S.CER C1005 CH 1H 120J-T	B	45.6/138.8
C325	4030017460	S.CER C1005 JB 1H 102K-T	B	135.6/83.3
C327	4030017640	S.CER C1005 CH 1H 150J-T	B	134.7/90.1
C328	4030017420	S.CER C1005 CH 1H 470J-T	B	142.8/85
C329	4030017640	S.CER C1005 CH 1H 150J-T	B	137.8/92.3
C330	4030017460	S.CER C1005 JB 1H 102K-T	B	36/142.3
C331	4030017460	S.CER C1005 JB 1H 102K-T	B	138.9/92.3
C332	4030017460	S.CER C1005 JB 1H 102K-T	B	60.4/142.5
C333	4030016930	S.CER C1005 JB 1A 104K-T	B	56/142.5
C334	4510009810	S.ELE EEEFK1E220R	T	23.1/29.4
C335	4030017390	S.CER C1005 CH 1H 180J-T	T	137.5/89.8
C336	4030017420	S.CER C1005 CH 1H 470J-T	B	144.3/89.3
C337	4030017400	S.CER C1005 CH 1H 220J-T	B	61.3/142.5
C338	4030017460	S.CER C1005 JB 1H 102K-T	B	144.3/88.2
C339	4030017460	S.CER C1005 JB 1H 102K-T	B	144.3/88.2
C340	4030016930	S.CER C1005 JB 1A 104K-T	B	36/139.4
C341	4030017420	S.CER C1005 CH 1H 470J-T	B	36/135.7
C342	4030017730	S.CER C1005 JB 1H 471K-T	T	52/20.3
C343	4550002890	S.TAN TEESVA 1A 225M8R	T	132.9/90.1
C344	4030017460	S.CER C1005 JB 1H 102K-T	T	138.8/108
C345	4030017460	S.CER C1005 JB 1H 102K-T	T	148.3/126
C346	4030017420	S.CER C1005 CH 1H 470J-T	B	36/134.8
C347	4030017460	S.CER C1005 JB 1H 102K-T	T	63.2/56.9
C348	4030017420	S.CER C1005 CH 1H 470J-T	T	145/127.7
C349	4030017400	S.CER C1005 CH 1H 220J-T	T	64.2/55.5
C350	4030017420	S.CER C1005 CH 1H 470J-T	B	144.2/91
C351	4030017460	S.CER C1005 JB 1H 102K-T	T	138.7/112.3
C353	4030017460	S.CER C1005 JB 1H 10		

[MAIN UNIT]

REF NO.	PARTS NO.	DESCRIPTION	M.	H/V LOCATION
C381	4030017400	S.CER C1005 CH 1H 220J-T	T	112.1/117
C382	4030017580	S.CER C1005 CH 1H 060C-T	B	24.1/141
C383	4030017460	S.CER C1005 JB 1H 102K-T	T	115.3/75.6
C384	4030018860	S.CER C1005 JB 0J 105K-T	T	138.6/127.7
C385	4030017660	S.CER C1005 CH 1H 330J-T	B	23.2/144.4
C386	4030017460	S.CER C1005 JB 1H 102K-T	T	136.6/127.7
C387	4030017390	S.CER C1005 CH 1H 180J-T	B	86/135.9
C388	4510009550	S.ELE EEEFK1C100R	T	123.3/76.8
C389	4030017200	S.CER GRM31BR32J102KY01L	B	94.2/132.5
C390	4030011170	S.CER GRM31M2C2H180JV01L (GRM42-6 CH)	T	84.7/131.6
C391	4030017460	S.CER C1005 JB 1H 102K-T	T	115.3/74
C392	4030017520	S.CER C1005 CH 1H 0R3B-T	B	86/130
C394	4550006250	S.TAN TEESVA 1A 106M8R	B	26.3/15.3
C396	4510009550	S.ELE EEEFK1C100R	T	97/77.8
C397	4030017460	S.CER C1005 JB 1H 102K-T	T	136.6/122.5
C398	4550006250	S.TAN TEESVA 1A 106M8R	B	31.7/15.5
C399	4030017460	S.CER C1005 JB 1H 102K-T	T	100/76.1
C400	4030017460	S.CER C1005 JB 1H 102K-T	B	85.6/103.9
C401	4030011170	S.CER GRM31M2C2H180JV01L (GRM42-6 CH)	B	103.4/131.2
C402	4030016930	S.CER C1005 JB 1A 104K-T	T	47.2/71.6
C404	4030017460	S.CER C1005 JB 1H 102K-T	T	143.1/127.7
C405	4030017420	S.CER C1005 CH 1H 470J-T	B	57.6/56.9
C406	4030016790	S.CER C1005 JB 1E 103K-T	T	103.5/76.2
C408	4030017460	S.CER C1005 JB 1H 102K-T	B	85.6/127.6
C409	4030011170	S.CER GRM31M2C2H180JV01L (GRM42-6 CH)	B	112.4/131.2
C410	4030011170	S.CER GRM31M2C2H180JV01L (GRM42-6 CH)	T	114.6/131.2
C411	4550007650	S.TAN F931V105MAABMA	T	37.5/68.6
C412	4030017460	S.CER C1005 JB 1H 102K-T	T	104.5/77.8
C413	4030016930	S.CER C1005 JB 1A 104K-T	T	38.5/71.9
C414	4030017420	S.CER C1005 CH 1H 470J-T	B	37.6/134
C415	4550007650	S.TAN F931V105MAABMA	T	37.5/63.4
C416	4550006250	S.TAN TEESVA 1A 106M8R	T	106.9/81.6
C417	4030016930	S.CER C1005 JB 1A 104K-T	T	15/125.7
C418	4550007650	S.TAN F931V105MAABMA	T	39.4/73.9
C419	4030011170	S.CER GRM31M2C2H180JV01L (GRM42-6 CH)	B	117.3/131.2
C420	4030016930	S.CER C1005 JB 1A 104K-T	B	27.4/18.5
C421	4030017460	S.CER C1005 JB 1H 102K-T	B	86.5/127.6
C422	4030017730	S.CER C1005 JB 1H 471K-T	B	119.6/139.5
C423	4030017460	S.CER C1005 JB 1H 102K-T	B	121.5/145.1
C424	4030016930	S.CER C1005 JB 1A 104K-T	T	14.1/125.7
C426	4030017640	S.CER C1005 CH 1H 150J-T	B	120.9/139.5
C428	4030017390	S.CER C1005 CH 1H 180J-T	B	144.3/86.6
C429	4030017460	S.CER C1005 CH 1H 102K-T	B	122.4/143.4
C431	4030018860	S.CER C1005 JB 0J 105K-T	B	33.3/13.6
C432	4030016930	S.CER C1005 JB 1A 104K-T	T	10.8/120.6
C433	4030017730	S.CER C1005 JB 1H 471K-T	B	139.5/138.1
C434	4030017460	S.CER C1005 JB 1H 102K-T	B	137.7/133.5
C435	4030017460	S.CER C1005 JB 1H 102K-T	T	54.8/29.8
C436	4030011170	S.CER GRM31M2C2H180JV01L (GRM42-6 CH)	B	143.7/137
C437	4030016930	S.CER C1005 JB 1A 104K-T	B	34.4/12
C438	4030016790	S.CER C1005 JB 1E 103K-T	T	109.7/89
C439	4510009810	S.ELE EEEFK1E220R	T	129.9/96.8
C440	4030018900	S.CER C1005 JB 0J 474K-T	T	7.9/129.6
C441	4030017440	S.CER C1005 CH 1H 221J-T	T	12/126.2
C442	4510009680	S.ELE EEEFK1E471P	B	9.6/119.8
C443	4030017460	S.CER C1005 JB 1H 102K-T	T	108.8/89
C444	4030011170	S.CER GRM31M2C2H180JV01L (GRM42-6 CH)	B	147/148.9
C445	4030017600	S.CER C1005 CH 1H 080C-T	B	26.1/141
C446	4030017460	S.CER C1005 JB 1H 102K-T	T	6.6/130.1
C448	4030017460	S.CER C1005 JB 1H 102K-T	T	126.9/103.4
C449	4510008870	S.ELE EEE1AA471UP	B	8.9/139.2
C450	4030019090	S.CER C2012 JB 1C 225M-T	T	7.5/125.1
C451	4030018860	S.CER C1005 JB 0J 105K-T	T	9.7/125.5
C452	4030018860	S.CER C1005 JB 0J 105K-T	T	71.5/98.2
C453	4030017460	S.CER C1005 JB 1H 102K-T	T	127.9/103.4
C454	4030017430	S.CER C1005 CH 1H 101J-T	B	46.3/56.9
C458	4030017460	S.CER C1005 JB 1H 102K-T	T	129.6/113.3
C459	4030017460	S.CER C1005 JB 1H 102K-T	T	117.8/117.7
C460	4030017460	S.CER C1005 JB 1H 102K-T	B	9.6/147.3
C461	4030017420	S.CER C1005 CH 1H 470J-T	T	130.5/113.3
C462	4030017420	S.CER C1005 CH 1H 470J-T	T	117.8/116.7
C463	4030017420	S.CER C1005 CH 1H 470J-T	B	9.6/146.4
C464	4510009680	S.ELE EEEFK1E471P	B	144.4/121.1
C465	4550006250	S.TAN TEESVA 1A 106M8R	T	96.1/87.8
C466	4030017420	S.CER C1005 CH 1H 470J-T	T	99.9/88
C467	4030016930	S.CER C1005 JB 1A 104K-T	T	62.3/58.5
C468	4030016930	S.CER C1005 JB 1A 104K-T	T	61.7/56.9
C469	4030017460	S.CER C1005 JB 1H 102K-T	B	141.3/90.1
C470	4030018860	S.CER C1005 JB 0J 105K-T	T	7.4/122.3
C471	4030016790	S.CER C1005 JB 1E 103K-T	T	6.2/123.6
C472	4030018860	S.CER C1005 JB 0J 105K-T	T	10.9/117.7
C473	4030018860	S.CER C1005 JB 0J 105K-T	T	5/118.9
C474	4030017780	S.CER C1005 JB 1H 472K-T	T	115.3/17.6
C475	4510008120	S.ELE 16 CE 100 BS	T	125.1/12.1
C476	4510008120	S.ELE 16 CE 100 BS	T	125.1/19.3
C477	4030017780	S.CER C1005 JB 1H 472K-T	T	118.9/12.2
C478	4030017780	S.CER C1005 JB 1H 472K-T	T	115.3/12.2
C479	4510008120	S.ELE 16 CE 100 BS	T	104.8/14.3
C481	4030017460	S.CER C1005 JB 1H 102K-T	B	63.2/122.2
C491	4030016930	S.CER C1005 JB 1A 104K-T	T	60.4/60.1
C492	4030016930	S.CER C1005 JB 1A 104K-T	B	13.5/32.6
C493	4510008870	S.ELE EEE1AA471UP	B	66.3/45.3
C494	4030017330	S.CER C1005 JF 1C 104Z-T	T	101.5/92.4
C495	4030016930	S.CER C1005 JB 1A 104K-T	T	101.5/90.1
C496	4030017330	S.CER C1005 JF 1C 104Z-T	T	123.3/92.9
C497	4030016930	S.CER C1005 JB 1A 104K-T	T	109.8/81.2
C498	4030016930	S.CER C1005 JB 1A 104K-T	T	11.4/43.2
C501	4030017420	S.CER C1005 CH 1H 470J-T	T	11.7/31.2

[MAIN UNIT]

REF NO.	PARTS NO.	DESCRIPTION	M.	H/V LOCATION
C502	4030017460	S.CER C1005 JB 1H 102K-T	T	29.5/2.8
C503	4030017420	S.CER C1005 CH 1H 470J-T	T	48/99.4
C506	4030016930	S.CER C1005 JB 1A 104K-T	B	26.3/43.3
C507	4030016930	S.CER C1005 JB 1A 104K-T	B	32.9/31
C508	4030016930	S.CER C1005 JB 1A 104K-T	B	40.1/42.7
C509	4030016930	S.CER C1005 JB 1A 104K-T	B	26.2/39
C510	4030016930	S.CER C1005 JB 1A 104K-T	B	26.6/33
C511	4030016930	S.CER C1005 JB 1A 104K-T	B	40.1/34.2
C512	4030017420	S.CER C1005 CH 1H 470J-T	T	92/14.7
C513	4550006250	S.TAN TEESVA 1A 106M8R	B	8.4/59.8
C514	4030016930	S.CER C1005 JB 1A 104K-T	B	11.7/53.5
C515	4030016930	S.CER C1005 JB 1A 104K-T	B	15.5/54.4
C516	4030016930	S.CER C1005 JB 1A 104K-T	T	65.1/69.6
C517	4030016930	S.CER C1005 JB 1A 104K-T	B	15.6/63.1
C518	4030016930	S.CER C1005 JB 1A 104K-T	B	12.4/62.4
C519	4030017460	S.CER C1005 JB 1H 102K-T	B	15.6/59.9
C521	4030016930	S.CER C1005 JB 1A 104K-T	B	18.1/53.6
C522	4030016930	S.CER C1005 JB 1A 104K-T	T	51.2/31.8
C523	4030016930	S.CER C1005 JB 1A 104K-T	T	51.2/33
C524	4030018910	S.CER C1608 JB 0J 475K-T	T	9.5/56
C525	4030018910	S.CER C1608 JB 0J 475K-T	B	25.8/58.3
C526	4030017730	S.CER C1005 JB 1H 471K-T	B	29.8/57.9
C527	4030016790	S.CER C1005 JB 1E 103K-T	B	26.1/50.3
C528	4030017670	S.CER C1005 CH 1H 390J-T	B	37.6/120.7
C529	4030017630	S.CER C1005 CH 1H 120J-T	B	39/112.2
C530	4030017420	S.CER C1005 CH 1H 470J-T	T	58.7/62.6
C531	4030017670	S.CER C1005 CH 1H 390J-T	B	93/61.9
C532	4030017670	S.CER C1005 CH 1H 390J-T	B	94.5/52
C533	4510008120	S.ELE 16 CE 100 BS	T	125.1/26.4
C534	4030016790	S.CER C1005 JB 1E 103K-T	T	118.4/26.7
C535	4030016790	S.CER C1005 JB 1E 103K-T	B	66.4/102.5
C536	4030016790	S.CER C1005 JB 1E 103K-T	B	64.8/99.1
C538	4030006860	S.CER C1608 JB 1H 102K-T	T	36.2/145.1
C539	4030017790	S.CER C1005 JB 1H 682K-T	T	22.8/57
C540	4030017730	S.CER C1005 JB 1H 471K-T	T	21.2/56.6
C541	4030016930	S.CER C1005 JB 1A 104K-T	T	22.8/81.4
C542	4030017440	S.CER C1005 CH 1H 221J-T	T	27.1/55
C543	4030016930	S.CER C1005 JB 1A 104K-T	T	56.3/68.9
C544	4030017460	S.CER C1005 JB 1H 102K-T	T	62.4/72.9
C545	40300011120	S.CER GRM31M2C2H100JV01L (GRM42-6 CH) [USA-01]	T	97.6/106.8
	40300011120	S.CER GRM31M2C2H100JV01L (GRM42-6 CH) [EXP-01]		
	40300011100	S.CER GRM31M2C2H8R0DV01L (GRM42-6 CH) [EUR-01]		
	40300011100	S.CER GRM31M2C2H8R0DV01L (GRM42-6 CH) [DPM-01]		
C546	4030018910	S.CER C1608 JB 0J 475K-T	B	40.4/56.7
C547	4030017760	S.CER C1005 JB 1H 222K-T	T	53.7/72.1
C548	4030016930	S.CER C1005 JB 1A 104K-T	T	14.1/120.6
C549	4030017420	S.CER C1005 CH 1H 470J-T	T	22/85.7
C550	4030017420	S.CER C1005 CH 1H 470J-T	T	71.5/85.1
C551	4030017330	S.CER C1005 JF 1C 104Z-T	T	114.1/28.1
C552	4030016790	S.CER C1005 JB 1E 103K-T	B	121.9/48.8
C553	4030016930	S.CER C1005 JB 1A 104K-T	B	30.8/19.4
C555	4030016930	S.CER C1005 JB 1A 104K-T	B	69.8/75.5
C556	4030017330	S.CER C1005 JF 1C 104Z-T	T	105.2/28.6
C557	4030016930	S.CER C1005 JB 1A 104K-T	T	97/28.6
C558	4550006250	S.TAN TEESVA 1A 106M8R	T	95.1/27.9
C559	4550007080	S.TAN TEESVA 1C 106M8R	T	45.9/75.5
C562	4030017420	S.CER C1005 CH 1H 470J-T	T	34.7/79.2
C563	4030016930	S.CER C1005 JB 1A 104K-T	B	25.6/112.6
C566	4030018860	S.CER C1005 JB 0J 105K-T	B	39/72.7
C570	4030017460	S.CER C1005 JB 1H 102K-T	B	70.7/136.1
C571	4030017580	S.CER C1005 CH 1H 060C-T	T	64/99.1
C572	4030017580	S.CER C1005 CH 1H 060C-T	T	64.9/99.1
C573	4030017580	S.CER C1005 CH 1H 060C-T	T	64.7/97.8
C574	4030017580	S.CER C1005 CH 1H 060C-T	B	61.4/134.9
C575	4030017420	S.CER C1005 CH 1H 470J-T	B	61.4/134
C576	4030017460	S.CER C1005 JB 1H 102K-T	T	67.3/105.8
C577	4030017460	S.CER C1005 JB 1H 102K-T	T	67.3/104.9
C578	4030017200	S.CER GRM31BR32J102KY01L	T	90.8/126
C579	4550006250	S.TAN TEESVA 1A 106M8R	B	98.3/46.9
C580	4030017420	S.CER C1005 CH 1H 470J-T	T	100.7/73.5
C581	4030018910	S.CER C1608 JB 0J 475K-T	B	46.3/60.9
C582	4030018910	S.CER C1608 JB 0J 475K-T	B	65.2/61.3
C583	4030016930	S.CER C1005 JB 1A 104K-T	B	46.3/58.6
C584	4030016790	S.CER C1005 JB 1E 103K-T	B	56.7/55.3
C585	4030016930	S.CER C1005 JB 1A 104K-T	B	54.9/58.6
C586	4030017730	S.CER C1005 JB 1H 471K-T	B	54.9/56.9
C587	4030016790	S.CER C1005 JB 1E 103K-T	B	

[MAIN UNIT]

REF NO.	PARTS NO.	DESCRIPTION	M.	H/V LOCATION
C632	4550007080	S.TAN TEESVA 1C 106M8R	B	111/23.3
C633	4550007080	S.TAN TEESVA 1C 106M8R	B	105.8/23.3
C634	4030017460	S.CER C1005 JB 1H 102K-T	B	108.4/22.1
C648	4510009680	S.ELE EEEFK1E471P	B	85.7/23.3
C649	4030018860	S.CER C1005 JB 0J 105K-T	T	71.2/64.2
C650	4030019120	S.CER GRM188B31E105KA75D	T	11.7/133.7
J1	6510026770	S.CON AXK540147YG	T	23.1/63.7
J2	6510023092	S.CON 20FLT-SM2-TB(LF)(SN)(M)	T	14.8/15.6
J4	6510023512	S.CON 28FLT-SM2-TB(LF)(SN)(M)	T	70.8/102
J5	6510023110	CON 3008L-8P8C <KIN>		
J6	6450000140	CON HSJ0807-01-010		
J8	6510023092	S.CON 20FLT-SM2-TB(LF)(SN)(M)	T	59.1/15.6
J9	6510019371	S.CON B3B-ZR-SM4-TF(LF)(SN)	T	94.6/14.3
J10	6510004910	CON NR-DS-E 01 <NIP>		
J11	6510004910	CON NR-DS-E 01 <NIP>		
DS1	5040002961	S.LED SML-A12MT T86J	B	96/1.1
DS2	5040002961	S.LED SML-A12MT T86J	B	126/1.1
DS3	5040003001	S.LED SML-A12UT T86J	B	111/1.1
MF1	2710000870	FAN AFB0512HB-7X22 <USE>HK		
EP1	6910015370	S.BEA ACZ1005Y-102-T	B	129.1/48.4
EP2	6910015370	S.BEA ACZ1005Y-102-T	B	115.5/45.6
EP3	6910015370	S.BEA ACZ1005Y-102-T	B	32.4/81.6
EP4	6910016330	S.BEA MMZ1005S 601CT-S	B	30.4/60.5
EP5	6910015370	S.BEA ACZ1005Y-102-T	B	39/74.3
EP6	6910015370	S.BEA ACZ1005Y-102-T	T	38.5/108.3
EP7	6910016330	S.BEA MMZ1005S 601CT-S	B	40.7/36.7
EP8	6910015370	S.BEA ACZ1005Y-102-T	B	95.4/49
EP9	6910016330	S.BEA MMZ1005S 601CT-S	T	48.8/39.3
EP10	6910011560	BEA HF70BB4.5X5X1.6		
EP13	6910011330	TER OT-009 M3		
EP14	6910011330	TER OT-009 M3		
EP16	6910018460	S.BEA MMZ1005Y102C-T	T	64.1/105
EP17	6910018460	S.BEA MMZ1005Y102C-T	T	65.1/105
EP18	6910018460	S.BEA MMZ1005Y102C-T	T	66.1/105
EP19	6910018460	S.BEA MMZ1005Y102C-T	T	66.1/106.8
EP20	6910018460	S.BEA MMZ1005Y102C-T	T	62.8/98.7
EP21	6910018460	S.BEA MMZ1005Y102C-T	T	62.8/99.6
EP22	6910018460	S.BEA MMZ1005Y102C-T	T	74.1/105
EP23	6910018460	S.BEA MMZ1005Y102C-T	T	73.2/105
EP24	6910018460	S.BEA MMZ1005Y102C-T	T	72.3/105
EP25	6910018460	S.BEA MMZ1005Y102C-T	T	71.1/105
EP26	6910018460	S.BEA MMZ1005Y102C-T	T	72.4/99
EP27	6910018460	S.BEA MMZ1005Y102C-T	T	68.2/99.1
EP28	6910018460	S.BEA MMZ1005Y102C-T	T	67.3/99.1
EP29	6910018460	S.BEA MMZ1005Y102C-T	T	65.8/99.1
EP30	6910018460	S.BEA MMZ1005Y102C-T	T	74.3/99
EP31	6910018460	S.BEA MMZ1005Y102C-T	T	70.6/98.2

[CONNECT UNIT]

REF NO.	PARTS NO.	DESCRIPTION	M.	H/V LOCATION
C601	4030017420	S.CER C1005 CH 1H 470J-T	T	13.8/12.4
C602	4030017400	S.CER C1005 CH 1H 220J-T	T	12.2/12.4
C603	4030017420	S.CER C1005 CH 1H 470J-T	T	16.5/12.4
C604	4030017400	S.CER C1005 CH 1H 220J-T	T	15/14.2
C605	4030017420	S.CER C1005 CH 1H 470J-T	T	17.8/13.9
C606	4030017420	S.CER C1005 CH 1H 470J-T	T	19.4/12.4
C607	4030017420	S.CER C1005 CH 1H 470J-T	T	20.5/13.9
C608	4030017420	S.CER C1005 CH 1H 470J-T	T	22.6/12.4
C609	4030017420	S.CER C1005 CH 1H 470J-T	T	25.5/12.4
C610	4030017420	S.CER C1005 CH 1H 470J-T	T	29.7/12.8
C611	4030017420	S.CER C1005 CH 1H 470J-T	T	31/14.1
C612	4030017420	S.CER C1005 CH 1H 470J-T	T	32.4/12.8
C613	4030017420	S.CER C1005 CH 1H 470J-T	T	33.5/14.1
C614	4030017420	S.CER C1005 CH 1H 470J-T	T	35.2/14.1
C615	4030017420	S.CER C1005 CH 1H 470J-T	T	35.7/12.8
C616	4030017420	S.CER C1005 CH 1H 470J-T	B	35.2/15.6
C617	4030017420	S.CER C1005 CH 1H 470J-T	T	37.5/13.5
C618	4030017420	S.CER C1005 CH 1H 470J-T	T	39.3/12.2
C619	4030017420	S.CER C1005 CH 1H 470J-T	T	39.9/13.4
C620	4030017420	S.CER C1005 CH 1H 470J-T	T	41.3/12.6
C621	4030017420	S.CER C1005 CH 1H 470J-T	T	27.4/13.9
J601	6510026290	S.CON IMSA-9631S-28Y921	B	22.8/16.2
J602	6510023210	CON CD6125SA1J0 <CVI>		
S1	2260003070	S.SWI MINISMDC150F/24-2	B	38.9/18
W601	8900017500	CAB OPC-1852 (P0.5,N28,L90) <TJM>		

M.=Mounted side (T: Mounted on the Top side, B: Mounted on the Bottom side)
S.=Surface mount

MAIN UNIT (2/3)

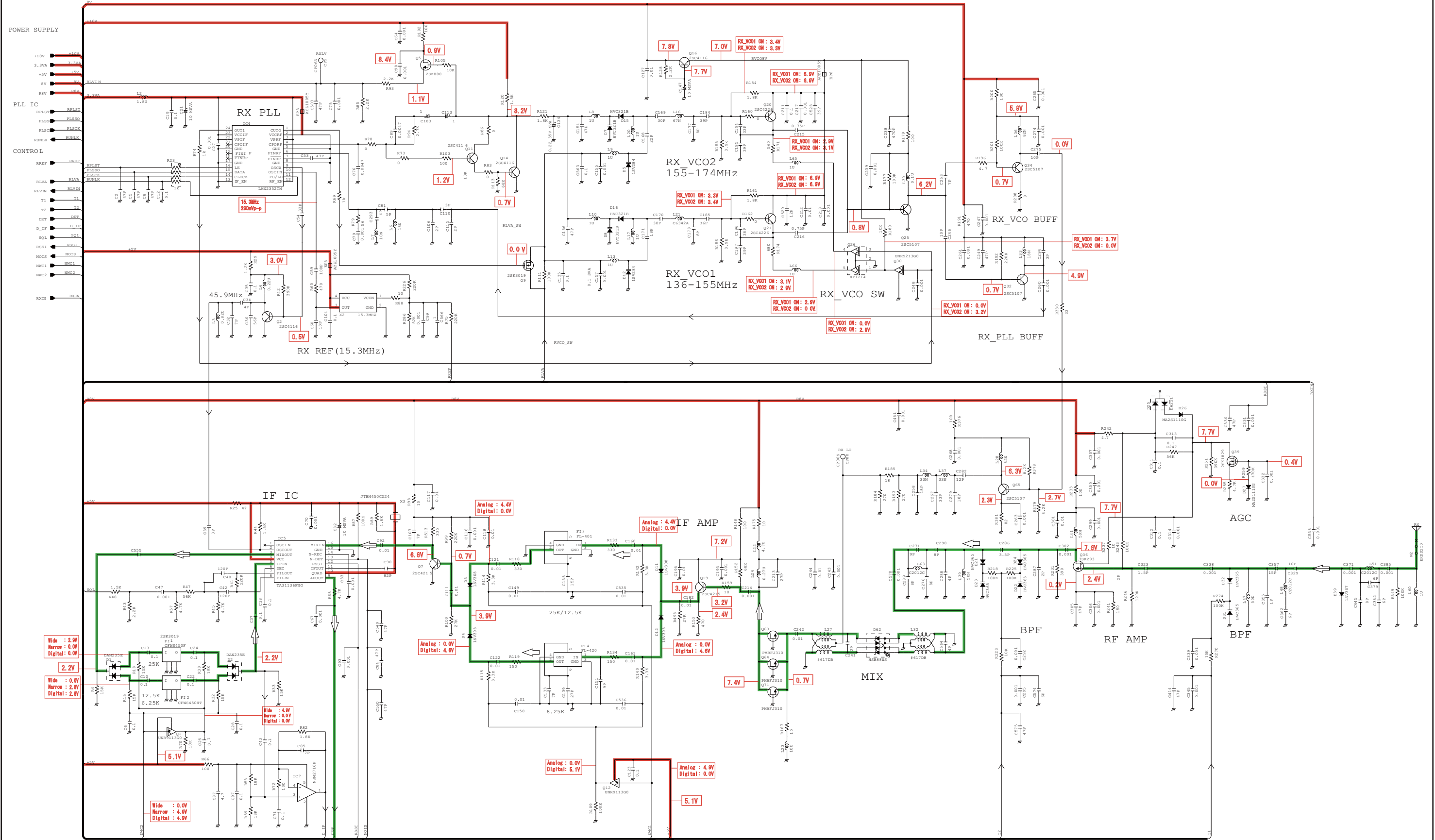

*; Refer to "PARTS LIST"

MAIN UNIT (3/3)

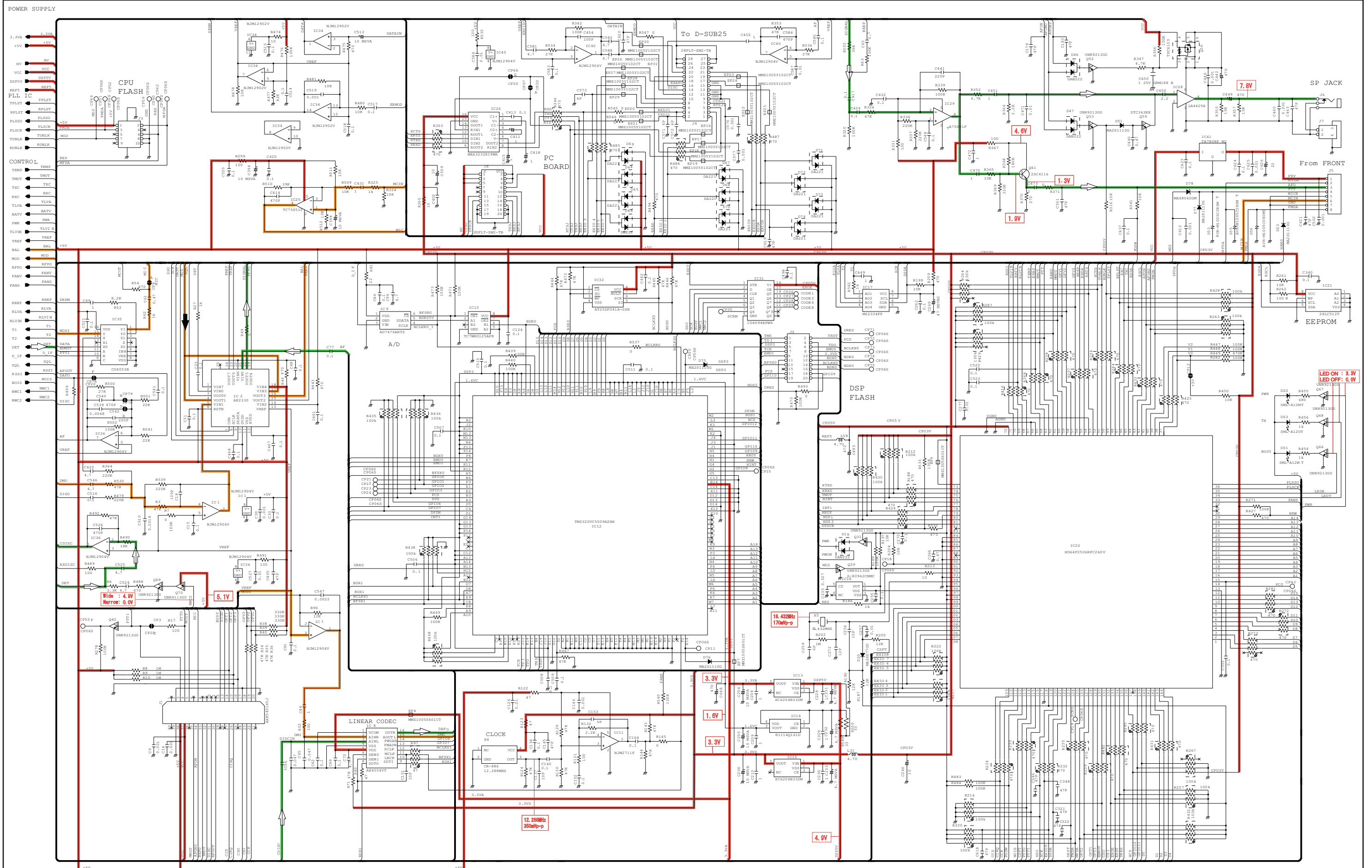

*; Refer to "PARTS LIST"

Nov. 2009



SERVICE MANUAL ADDENDUM

UR-FR5000 UR-FR5100

CONTENTS

PARTS LIST	1
BOARD LAYOUTS	8
VOLTAGE DIAGRAM	10

PARTS LIST

[MAIN UNIT]

REF NO.	PARTS NO.	DESCRIPTION	M.	H/V LOCATION
IC1	1110005330	S.IC NJM12904V-TE1-#ZZZB	T	58.1/71.4
IC2	1110007290	S.IC AK2330P-L	T	58.7/56.1
IC3	1130010100	S.IC LMX2352TMX/NOPB	B	120.2/43.9
IC4	1130010100	S.IC LMX2352TMX/NOPB	B	28/78.8
IC5	1110003491	S.IC TA31136FNG(D,EL)	B	70.4/82.5
IC7	1110007280	S.IC NJM2716F-TE1-#ZZZB	B	56.8/46.4
IC8	1130012910	S.IC AK4554VTP-E2/P	B	36.2/59.9
IC9	1190002080	S.IC AD7476ARTZ-500RL7 <FE>	B	49.6/46.4
IC10	1130013040	S.IC TC7WBD125AFK(T5L,F)	B	46.6/49.2
IC11	1110006230	S.IC NJM2711F-TE1-#ZZZB	B	53.1/35
IC12	1140013290	S.IC TMS320VC5509AZHH	B	33.3/37.8
IC13	1180002590	S.REG XC6204B332MR	T	80.9/21.3
IC14	1180003270	S.REG R1114Q161D-TR-F	T	84.4/21.4
IC15	1180002590	S.REG XC6204B332MR	T	87.8/21.3
IC17	1190001340	S.IC M62334FP 600C	T	67.3/61.7
IC18	1110005771	S.IC S-80942CNMC-G9CT2G	T	41.2/52.8
IC19	1180003210	S.REG NJM2831F10-TE1-#ZZZB	B	111/26.2
IC20	1140014550	S.IC HD64F2506RFC26DV(EMPTY)	T	33.5/37.6
IC21	1140012950	S.IC 24LC512T-I/SM <SEI>	T	59.1/21.8
IC22	1150002073	IC RA60H1317M-125 [USA-01]		
	1150002073	IC RA60H1317M-125 [EXP-01]		
	1150002042	IC RA30H1317M-121 [EUR-01]		
IC23	1110002751	S.IC TA75S01F(TE85R,F)	T	141.7/125.1
IC25	1130008561	S.IC TC75S51F(TE85L,F)	B	29/16.3
IC26	1120003070	S.IC MAX3232EIPWR	T	42.7/70
IC27	1180001252	S.IC TA7808F(TE16L1,NQ)	T	114.4/85
IC28	1110003091	IC LA4425A-E		
IC29	1110002751	S.IC TA75S01F(TE85R,F)	T	12/123.1
IC30	1110003390	S.IC AN8005M-(E1)	T	98.3/91.4
IC31	1130011760	S.IC CD4094BPWR	T	8.1/45.2
IC32	1130013360	S.IC AT25F2048N-10SU-2.7SL383 0	B	8.9/36.1
IC34	1110005340	S.IC NJM12902V-TE1-#ZZZB	B	12.2/58.2
IC35	1140013200	S.IC CD4053BPWR	B	20.6/58.2
IC36	1110005330	S.IC NJM12904V-TE1-#ZZZB	B	27.8/55.4
IC37	1120002830	S.IC NJM2125F-TE1-#FZZB	T	56.6/66.7
IC38	1110006380	S.IC LM2904PWR	T	114.1/23.8
IC39	1180001072	S.IC TA7805F(TE16L1,NQ)	T	101.2/24.3
IC40	1110005330	S.IC NJM12904V-TE1-#ZZZB	B	50.6/57.2
IC41	1180001252	S.IC TA7808F(TE16L1,NQ)	B	132/16.7
Q1	1590003231	S.TRA UNR9113G0L	B	53.4/79.7
Q2	1530002851	S.TRA 2SC4116-BL(TE85R,F)	B	34.9/77.7
Q3	1560001360	S.FET 2SK3019 TL	B	66.4/76.3
Q5	1560000541	S.FET 2SK880-Y(T5RICOM,F)	B	35.7/107.1
Q7	1530002601	S.TRA 2SC4215-O(TE85R,F)	B	73/92.9
Q8	1560000541	S.FET 2SK880-Y(T5RICOM,F)	B	89.5/46
Q9	1560001360	S.FET 2SK3019 TL	B	39.6/103.6
Q10	1530002851	S.TRA 2SC4116-BL(TE85R,F)	B	89.5/43.5
Q11	1530002851	S.TRA 2SC4116-BL(TE85R,F)	B	30.6/104.2
Q12	1590003231	S.TRA UNR9113G0L	B	66.1/100.3
Q13	1530002851	S.TRA 2SC4116-BL(TE85R,F)	B	84.7/43.5
Q14	1530002851	S.TRA 2SC4116-BL(TE85R,F)	B	30.6/107.1
Q15	1530002851	S.TRA 2SC4116-BL(TE85R,F)	B	96.9/44.4
Q16	1530002851	S.TRA 2SC4116-BL(TE85R,F)	T	35.2/108.3
Q19	1530002601	S.TRA 2SC4215-O(TE85R,F)	B	63.2/106.8
Q20	1530002920	S.TRA 2SC4226-T1 R25	B	39.9/123.1
Q21	1530002920	S.TRA 2SC4226-T1 R25	B	39.6/114.5
Q22	1530002920	S.TRA 2SC4226-T1 R25	B	95.2/64.3
Q23	1530002920	S.TRA 2SC4226-T1 R25	B	95.2/54.5
Q24	1530003311	S.TRA 2SC5107-O(TE85R,F)	B	100.6/58.6
Q25	1530003311	S.TRA 2SC5107-O(TE85R,F)	B	44.9/117.4
Q26	1590001400	S.TRA XP1214(TX)	B	40.5/117.8
Q27	1590001400	S.TRA XP1214(TX)	B	96/59.6
Q28	1590003291	S.TRA UNR9213G0L	B	93.3/59.6
Q29	1590003291	S.TRA UNR9213G0L	T	57.2/41.9
Q30	1590003291	S.TRA UNR9213G0L	B	37.8/117.8
Q31	1590003231	S.TRA UNR9113G0L	T	57.2/39.8
Q32	1530003311	S.TRA 2SC5107-O(TE85R,F)	B	46.2/111.7
Q33	1530003311	S.TRA 2SC5107-O(TE85R,F)	B	101.9/53
Q34	1530003311	S.TRA 2SC5107-O(TE85R,F)	B	46.2/123.1
Q35	1530003311	S.TRA 2SC5107-O(TE85R,F)	B	101.9/64.4
Q36	1580000731	S.FET 3SK293(TE85L,F)	B	48.3/136.6
Q37	1530003311	S.TRA 2SC5107-O(TE85R,F)	B	132.4/84.5
Q38	1530002680	S.FET 2SC3357-T1	B	139.5/86
Q39	1560000841	S.FET 2SK1829(TE85R,F)	B	54.2/142.5
Q40	1590001190	S.TRA XP6501-(TX).AB	T	101.6/87.4
Q41	1520000460	S.TRA 2SB1132 T100 R	T	101.6/82.8
Q42	1590003291	S.TRA UNR9213G0L	T	13.3/67.6
Q43	1590003291	S.TRA UNR9213G0L	T	137.3/125
Q44	1590003291	S.TRA UNR9213G0L	T	114.3/80.1
Q45	1540000550	S.TRA 2SD1664 T100Q	T	118.4/75.2
Q46	1530002851	S.TRA 2SC4116-BL(TE85R,F)	T	137.3/120.2
Q48	1510000920	S.TRA 2SA1577 T106 Q	T	101.5/77.8
Q49	1590003291	S.TRA UNR9213G0L	T	102.2/73.7
Q52	1590003291	S.TRA UNR9213G0L	T	10.9/131.6
Q53	1590003291	S.TRA UNR9213G0L	T	10.9/129.6
Q56	1590003560	S.FET TPC6104 (TE85L,F)	T	7.6/132.6
Q57	1550000190	S.FET 2SJ506STR-E	T	123.3/99.6
Q58	1590003291	S.TRA UNR9213G0L	T	129.4/102.2
Q59	1590000990	S.TRA DTC363EK T146	T	7.6/127.6
Q61	1530002851	S.TRA 2SC4116-BL(TE85R,F)	T	6.8/118.4
Q62	1540000441	S.TRA 2SD1619T-TD-E	T	118.4/18.6
Q63	1560000990	S.FET PMBFJ310	B	66.3/110
Q64	1560000990	S.FET PMBFJ310	B	63.4/110
Q65	1530003311	S.TRA 2SC5107-O(TE85R,F)	B	59.6/123.7
Q66	1590003291	S.TRA UNR9213G0L	B	94.9/4.7
Q67	1590003291	S.TRA UNR9213G0L	B	124.9/4.7

[MAIN UNIT]

REF NO.	PARTS NO.	DESCRIPTION	M.	H/V LOCATION
Q68	1590003291	S.TRA UNR9213G0L	B	109.9/4.7
Q69	1590003291	S.TRA UNR9213G0L	T	9.5/53.3
Q70	1590003231	S.TRA UNR9113G0L	T	9.5/51
Q71	1560000990	S.FET PMBFJ310	B	60.5/110
Q72	1530002851	S.TRA 2SC4116-BL(TE85R,F)	B	107/26.3
D1	1750001070	S.DIO DAN235ETL	B	57.3/78.6
D2	1750001070	S.DIO DAN235ETL	B	50/79.7
D3	1790001621	S.DIO 1SV308(TPL3,F)	B	69.3/94.8
D4	1790001621	S.DIO 1SV308(TPL3,F)	B	69.3/92.2
D5	1720000641	S.VAR 1SV284(TPH3,F)	B	29.9/120.1
D7	1720000791	S.VAR HVC321B1TRF-E	B	28.6/125.1
D8	1720000791	S.VAR HVC321B1TRF-E	B	26.5/113.3
D9	1720000791	S.VAR HVC321B1TRF-E	B	84.7/59.8
D10	1720000791	S.VAR HVC321B1TRF-E	B	86.4/51.2
D11	1790001621	S.DIO 1SV308(TPL3,F)	B	63.5/103.1
D12	1790001621	S.DIO 1SV308(TPL3,F)	B	62.4/101.1
D13	1720000791	S.VAR HVC321B1TRF-E	B	84.9/61.8
D14	1720000791	S.VAR HVC321B1TRF-E	B	84.4/52
D15	1720000791	S.VAR HVC321B1TRF-E	B	28.6/122.6
D16	1720000791	S.VAR HVC321B1TRF-E	B	26.5/114.6
D17	1720000641	S.VAR 1SV284(TPH3,F)	B	83.5/63.5
D18	1720000471	S.VAR 1SV239(TPH3,F)	B	96.3/66.7
D19	1750000520	S.DIO DAN222TL	T	59.6/39.8
D20	1790001261	S.DIO MA2S077G0L	T	39.5/57.9
D21	1750001610	S.VAR HVC365TRF-E	B	63/139.4
D22	1750001610	S.VAR HVC365TRF-E	B	59.8/136.7
D23	1750001610	S.VAR HVC365TRF-E	B	63/136.7
D24	1750001610	S.VAR HVC365TRF-E	B	59.8/139.4
D25	1750000370	S.DIO DA221 TL	B	46.5/142.5
D26	1790001251	S.DIO MA2S1110GL	B	48.3/142.5
D27	1790001251	S.DIO MA2S1110GL	B	58.3/142.5
D30	1720000471	S.VAR 1SV239(TPH3,F)	B	95.6/56.8
D31	1750001610	S.VAR HVC365TRF-E	B	34.4/135.7
D32	1750001610	S.VAR HVC365TRF-E	B	34.4/138.4
D35	1750000351	S.DIO 1SV252(TE85L,F)	B	143.7/92.9
D36	1750001080	S.DIO RB886G T2R	T	144.4/120.2
D37	1750001080	S.DIO RB886G T2R	T	145.6/120.2
D38	1750001360	S.DIO L709CER (9401)	B	84.7/134
D39	1750000581	S.DIO 1SV307(TPH3,F)	B	36/144.8
D40	1750000370	S.DIO DA221 TL	T	114.3/77.8
D42	1720000641	S.VAR 1SV284(TPH3,F)	B	26.5/112
D44	1710001061	DIO L407CDB		
D45	1790001211	S.DIO 1SS375-TL-E	B	83.8/128
D46	1750000520	S.DIO DAN222TL	T	13.3/131.1
D47	1750000520	S.DIO DAN222TL	T	13.2/129.1
D48	1790001211	S.DIO 1SS375-TL-E	B	119.6/144.5
D49	1790001211	S.DIO 1SS375-TL-E	B	139.5/133.2
D51	1790001251	S.DIO MA2S1110GL	T	10.5/127.1
D53	1790001810	S.VAR AVR-M1005C080MTABB	T	32.5/11.7
D55	1790001810	S.VAR AVR-M1005C080MTABB	T	30.5/11.7
D56	1790001810	S.VAR AVR-M1005C080MTABB	T	36.6/11.7
D59	1790000700	DIO DSA3A1		
D61	1750000520	S.DIO DAN222TL	T	118.4/14.7
D62	1750000431	S.DIO HSB88WSTR-E	B	68.3/123.3
D63	1790001251	S.DIO MA2S1110GL	B	34.2/20.8
D64	1750000370	S.DIO DA221 TL	T	63.2/93.9
D65	1750000370	S.DIO DA221 TL	T	65.2/93.9
D66	1750000370	S.DIO DA221 TL	T	67.2/93.9
D67	1750000370	S.DIO DA221 TL	T	61.9/105.9
D68	1750000370	S.DIO DA221 TL	T	59.9/105.5
D69	1750000370	S.DIO DA221 TL	T	69.2/93.9
D70	1750000370	S.DIO DA221 TL	T	71.2/93.9
D71	1750000370	S.DIO DA221 TL	T	69.1/109.5
D72	1750000370	S.DIO DA221 TL	T	71.2/109.5
D73	1750000370	S.DIO DA221 TL	T	73.3/109.5
D74	1750000370	S.DIO DA221 TL	T	75.3/109.5
D75	1790001251	S.DIO MA2S1110GL	B	41/38.6
D76	1790001251	S.DIO MA2S1110GL	B	26.4/41.3
D77	1790001251	S.DIO MA2S1110GL	B	49.2/29.9
D78	1730002361	S.ZEN MAZ8062GML	B	52.3/29.9
D79	1720000641	S.VAR 1SV284(TPH3,F)	B	83.1/52
F11	2020001520	CER CFWLA450KFFA-B0 (CFWS450F)		
F12	2020001460	CER CFWLA450KHFA-B0 (CFWS450HT)		
F13	2030000500	S.MON DSF753SFBF 46.35 MHz (FL-401)	B	72/101
F14	2030000670	S.MON DSF753SFBF 46.35 MHz (FL-420)	B	63.4/91.1
F15	2040001440	S.LC NFE31PT152Z1E9L (NFM60R20T152)	T	116.5/108.3
F16	2040001440	S.LC NFE31PT152Z1E9L (NFM60R20T152)	T	116.5/111.5
F17	2040001440	S.LC NFE31PT152Z1E9L (NFM60R20T152)	T	116.5/114.6
X1	6050012380	S.XTA CR-826 DSA535SD 15.3 MHz	B	128.6/45.3
X2	6050012380	S.XTA CR-826 DSA535SD 15.3 MHz	B	35.6/72.3
X3	6070000300	S.DIS JTBM450CX24 <LJE>	B	63.5/83.5
X4	6050012930	S.XTA CR-886 DSA321SCA 12.288 MHz	B	52.8/38.2
X5	6050012680	S.XTA CR-858 (SMD-49/18.432 MHz) <LJE>	T	46.9/52.7
L1	6200004660	S.COI MLF1608A 1R8K-T	B	115.5/39.2

M.=Mounted side (T: Mounted on the Top side, B: Mounted on the Bottom side)
S.=Surface mount

[MAIN UNIT]

REF NO.	PARTS NO.	DESCRIPTION	M.	H/V LOCATION
L2	6200004660	S.COI MLF1608A 1R8K-T	B	23.6/82.4
L3	6200004480	S.COI MLF1608D R82K-T	B	39.4/79.3
L4	6200003540	S.COI MLF1608D R22K-T	B	36.9/76.9
L5	6200005691	S.COI ELJRE 18NGFA	B	102.7/45.6
L6	6200005691	S.COI ELJRE 18NGFA	B	47.3/101.1
L7	6200005661	S.COI ELJRE 10NGFA	B	44/99.1
L8	6200007120	S.COI ELJND 1R0J	B	27/124.1
L9	6200007120	S.COI ELJND 1R0J	B	27/120.8
L10	6200007120	S.COI ELJND 1R0J	B	25.9/116.8
L11	6200007120	S.COI ELJND 1R0J	B	82.5/61.4
L12	6200007120	S.COI ELJND 1R0J	B	83.1/49.9
L13	6200007120	S.COI ELJND 1R0J	B	28.7/111.6
L14	6200007120	S.COI ELJND 1R0J	B	85.3/66.4
L15	6200013220	S.COI C6342A-R13G-A	B	88.6/54.6
L16	6200010600	S.COI C6342A-67NG-A	B	33.8/122.7
L17	6200007120	S.COI ELJND 1R0J	B	28.7/116.8
L18	6200009910	S.COI C6342A-88NG-A	B	88.8/63.9
L19	6200007120	S.COI ELJND 1R0J	B	83.5/66.4
L20	6200007120	S.COI ELJND 1R0J	B	30.2/124.7
L21	6200009910	S.COI C6342A-88NG-A	B	33.1/114.4
L22	6200003550	S.COI MLF1608A 4R7K-T	B	73.4/109.9
L23	6200005011	S.COI NLV25T-100J	B	60.5/113.3
L24	6200010740	S.COI C2520C-R27G-A	B	70/109.1
L25	6200007120	S.COI ELJND 1R0J	B	97.4/62.5
L26	6200007120	S.COI ELJND 1R0J	B	98/56.1
L27	6130002961	S.COI #617DB-1327=P3	B	68.3/117
L28	6200007001	S.COI ELJRE 82NGFA	B	62.3/123.6
L29	6200006981	S.COI ELJRE R10GFA	B	102.6/58.6
L30	6200006981	S.COI ELJRE R10GFA	B	46.9/117.4
L31	6200002861	S.COI NLV25T-4R7J	T	91.2/20
L32	6130002961	S.COI #617DB-1327=P3	B	68.3/128.7
L33	6200005691	S.COI ELJRE 18NGFA	B	47.3/109.2
L34	6200005721	S.COI ELJRE 33NGFA	B	61.1/117.5
L35	6200005691	S.COI ELJRE 18NGFA	B	102.7/50.5
L36	6200007001	S.COI ELJRE 82NGFA	B	44.3/123.1
L37	6200005721	S.COI ELJRE 33NGFA	B	61.1/120.1
L38	6200007001	S.COI ELJRE 82NGFA	B	100/64.4
L39	6200010610	S.COI C6342A-50NG-A	B	67.4/138.5
L41	6200010610	S.COI C6342A-50NG-A	B	53.7/136.7
L42	6200006981	S.COI ELJRE R10GFA	B	134.5/84.5
L43	6200006671	S.COI ELJRE 68NGFA	B	138.9/90.1
L45	6200005741	S.COI ELJRE 47NGFA	B	142.8/87.4
L46	6200005741	S.COI ELJRE 47NGFA	B	142.8/90.1
L47	6200010610	S.COI C6342A-50NG-A	B	29.9/136.7
L48	6200010000	S.COI C2012C-56NG-A	B	33.3/141.2
L49	6200010050	S.COI AS080547-47N	B	97.2/119.2
L50	6200007750	S.COI LQW2BHNS56N.J03L	B	85.5/137.4
L51	6200010000	S.COI C2012C-56NG-A	B	25.1/142.9
L52	6200010420	S.COI FHW1210HC 1R0JGT <JJE>	B	86.6/122.3
L53	6200010050	S.COI AS080547-47N	B	90.1/135.3
L55	6200010050	S.COI AS080547-47N	B	107.6/135
L56	6200010050	S.COI AS080547-47N	B	115.2/138.8
L57	6200010050	S.COI AS080547-47N	B	143.7/140.9
L58	6200002861	S.COI NLV25T-4R7J	T	55.4/37.5
L59	6200010420	S.COI FHW1210HC 1R0JGT <JJE>	B	147.1/146.2
L60	6200010420	S.COI FHW1210HC 1R0JGT <JJE>	B	24.5/147
L61	6200002961	S.COI NLV32T-4R7J	T	118.4/23.8
L62	6200013530	S.COI MLF2012E 100K-T	B	83.7/56.6
L63	6200010000	S.COI C2012C-56NG-A	B	72.3/137.8
L64	6200007120	S.COI ELJND 1R0J	B	81.8/54.9
L65	6200007120	S.COI ELJND 1R0J	B	41.7/120.7
L66	6200007120	S.COI ELJND 1R0J	B	42.4/115.2
L68	6200003960	S.COI MLF1608A 1R0K-T	B	140.7/94.7
L69	6200005661	S.COI ELJRE 10NGFA	B	102.7/42.3
R1	7030005310	S.RES ERJ2GEJ 124 X (120K)	T	54.9/64.1
R2	7030005050	S.RES ERJ2GEJ 103 X (10K)	T	58.7/61.7
R3	7030005240	S.RES ERJ2GEJ 473 X (47K)	T	62.4/69.6
R4	7030007340	S.RES ERJ2GEJ 153 X (15K)	B	57.3/80.1
R6	7030007300	S.RES ERJ2GEJ 332 X (3.3K)	T	9.5/57.1
R7	7030010040	S.RES ERJ2GEJ-JPW	T	61.6/66.3
R8	7030005160	S.RES ERJ2GEJ 105 X (1M)	T	24.9/70.4
R9	7030005160	S.RES ERJ2GEJ 105 X (1M)	T	25.8/70.4
R10	7030005160	S.RES ERJ2GEJ 105 X (1M)	T	26.7/70.4
R12	7510001730	S.THE ERTJOEP 473J	B	129.1/49.3
R13	7030005090	S.RES ERJ2GEJ 104 X (100K)	B	130.8/49.3
R15	7030007340	S.RES ERJ2GEJ 153 X (15K)	B	54.5/78.3
R17	7030004980	S.RES ERJ2GEJ 101 X (10K)	T	19.8/68.8
R18	7030007340	S.RES ERJ2GEJ 153 X (15K)	B	55.3/79.2
R20	7030009150	S.RES ERJ2GEJ 824 X (820K)	T	56.1/63.5
R22	7410001130	S.ARR EXB28V102JX	B	122.6/39
R23	7410001130	S.ARR EXB28V102JX	B	23.1/76.3
R24	7030005120	S.RES ERJ2GEJ 102 X (1K)	B	115.5/42.2
R25	7030004970	S.RES ERJ2GEJ 470 X (47)	B	65.3/79.4
R26	7030010040	S.RES ERJ2GEJ-JPW	T	57.7/64.5
R27	7030005120	S.RES ERJ2GEJ 102 X (1K)	T	57.8/51
R29	7030007570	S.RES ERJ2GEJ 122 X (1.2K)	B	38.5/75.9
R30	7030007340	S.RES ERJ2GEJ 153 X (15K)	B	52.8/81.1
R32	7030007340	S.RES ERJ2GEJ 153 X (15K)	B	51.2/78.3
R33	7030007340	S.RES ERJ2GEJ 153 X (15K)	B	48.4/78.2
R34	7030005240	S.RES ERJ2GEJ 473 X (47K)	T	27.1/68.1
R35	7030005240	S.RES ERJ2GEJ 473 X (47K)	T	28/68.1
R36	7030005240	S.RES ERJ2GEJ 473 X (47K)	T	28.9/68.1
R38	7030005230	S.RES ERJ2GEJ 334 X (330K)	T	27.6/70.4
R39	7030005230	S.RES ERJ2GEJ 334 X (330K)	T	28.6/70.4
R40	7030005230	S.RES ERJ2GEJ 334 X (330K)	T	29.5/70.4
R41	7030005110	S.RES ERJ2GEJ 224 X (220K)	B	68.2/78.2
R42	7030006610	S.RES ERJ2GEJ 394 X (390K)	B	34.4/75.5
R43	7030007290	S.RES ERJ2GEJ 222 X (2.2K)	B	62.8/77.3
R44	7030005030	S.RES ERJ2GEJ 152 X (1.5K)	B	71.4/78.2
R45	7030005040	S.RES ERJ2GEJ 472 X (4.7K)	B	64.6/75.5
R46	7030005000	S.RES ERJ2GEJ 471 X (4.7K)	T	52.7/57.1
R47	7030005720	S.RES ERJ2GEJ 563 X (56K)	B	64.6/76.4
R48	7030005030	S.RES ERJ2GEJ 152 X (1.5K)	B	62.8/76.4

[MAIN UNIT]

REF NO.	PARTS NO.	DESCRIPTION	M.	H/V LOCATION
R49	7030010040	S.RES ERJ2GEJ-JPW	T	55.6/57.3
R52	7030004980	S.RES ERJ2GEJ 101 X (100)	B	34.1/56.4
R53	7030005210	S.RES ERJ2GEJ 822 X (8.2K)	B	16.8/57.6
R54	7030005000	S.RES ERJ2GEJ 471 X (47)	B	19.4/64.3
R56	7030004970	S.RES ERJ2GEJ 470 X (4.7K)	B	121.9/50.4
R57	7030005040	S.RES ERJ2GEJ 472 X (4.7K)	B	62.8/75.5
R58	7030008290	S.RES ERJ2GEJ 183 X (18K)	B	56.5/49
R59	7030008290	S.RES ERJ2GEJ 183 X (18K)	B	57.4/49
R60	7030005000	S.RES ERJ2GEJ 471 X (4.7K)	B	32.3/74.3
R62	7030005120	S.RES ERJ2GEJ 102 X (1K)	B	18.5/62.5
R63	7030005090	S.RES ERJ2GEJ 104 X (100K)	T	55.6/60.5
R65	7030005000	S.RES ERJ2GEJ 471 X (47)	B	125.1/47.3
R66	7030004980	S.RES ERJ2GEJ 101 X (100)	B	56.5/50.6
R68	7030005040	S.RES ERJ2GEJ 472 X (4.7K)	B	67.5/86.7
R69	7030005120	S.RES ERJ2GEJ 102 X (1K)	B	32.7/83
R70	7030005050	S.RES ERJ2GEJ 103 X (10K)	B	69.8/71.9
R71	7030005240	S.RES ERJ2GEJ 471 X (47K)	B	31/62.6
R72	7030004980	S.RES ERJ2GEJ 101 X (100)	B	57.6/44.2
R73	7030010040	S.RES ERJ2GEJ-JPW	B	28.3/100.4
R74	7030005120	S.RES ERJ2GEJ 102 X (1K)	B	25.8/83.5
R75	7030005110	S.RES ERJ2GEJ 224 X (220K)	B	39.9/71.1
R76	7030010040	S.RES ERJ2GEJ-JPW	B	93.7/41.6
R77	7030005580	S.RES ERJ2GEJ 560 X (56)	B	119.7/48.8
R78	7030010040	S.RES ERJ2GEJ-JPW	B	29.9/99.3
R79	7030005580	S.RES ERJ2GEJ 560 X (56)	B	32.7/79.5
R80	7030004970	S.RES ERJ2GEJ 470 X (4.7K)	B	23.5/41.1
R81	7030007250	S.RES ERJ2GEJ 220 X (22)	B	49.9/50.5
R82	7030008400	S.RES ERJ2GEJ 182 X (1.8K)	B	56/44.2
R83	7030010040	S.RES ERJ2GEJ-JPW	B	32.4/106.5
R84	7030007290	S.RES ERJ2GEJ 222 X (2.2K)	B	93.7/47.1
R85	7030007290	S.RES ERJ2GEJ 222 X (2.2K)	B	37.8/107.1
R86	7030010040	S.RES ERJ2GEJ-JPW	B	33.2/105.2
R87	7030005090	S.RES ERJ2GEJ 104 X (100K)	B	73.7/81.1
R88	7030005530	S.RES ERJ2GEJ 100 X (10)	B	39/71.1
R89	7030008400	S.RES ERJ2GEJ 182 X (1.8K)	B	67.1/83.2
R90	7030008010	S.RES ERJ2GEJ 123 X (12K)	T	54.5/73.3
R91	7030007290	S.RES ERJ2GEJ 222 X (2.2K)	B	92.1/47.1
R92	7030009140	S.RES ERJ2GEJ 272 X (2.7K)	B	92.1/41.6
R93	7030007290	S.RES ERJ2GEJ 222 X (2.2K)	B	37.8/106.1
R94	7030009140	S.RES ERJ2GEJ 272 X (2.7K)	B	28.3/98.3
R97	7410001170	S.ARR EXB28V470JX	B	42.9/49.9
R98	7030005530	S.RES ERJ2GEJ 100 X (10)	B	71/95.7
R99	7030005110	S.RES ERJ2GEJ 224 X (220K)	B	71/92.9
R100	7030005600	S.RES ERJ2GEJ 273 X (27K)	B	67.9/93.8
R101	7030004980	S.RES ERJ2GEJ 101 X (100)	B	92.1/46.2
R102	7030004980	S.RES ERJ2GEJ 101 X (100)	B	34.8/105.2
R103	7030004980	S.RES ERJ2GEJ 101 X (100)	B	28.3/101.3
R105	7030005050	S.RES ERJ2GEJ 103 X (10K)	B	33.7/107.9
R107	7030004980	S.RES ERJ2GEJ 101 X (100)	B	87.1/47.1
R109	7030005090	S.RES ERJ2GEJ 104 X (100K)	B	64.8/98.2
R111	7030005090	S.RES ERJ2GEJ 104 X (100K)	B	37.8/104.4
R112	7030005070	S.RES ERJ2GEJ 683 X (68K)	B	84.7/45.3
R113	7030005070	S.RES ERJ2GEJ 683 X (68K)	B	32.4/108.1
R114	7030007300	S.RES ERJ2GEJ 332 X (3.3K)	B	67.4/96.2
R115	7030007300	S.RES ERJ2GEJ 332 X (3.3K)	B	67.9/91.2
R116	7030005050	S.RES ERJ2GEJ 103 X (10K)	B	87.1/45.3
R117	7030005810	S.RES RR0510P-152-D (1.5K)	B	87.1/46.2
R118	7030007280	S.RES ERJ2GEJ 351 X (330)	B	72.8/94.8
R119	7030007270	S.RES ERJ2GEJ 151 X (150)	B	68.1/89
R120	7030005810	S.RES RR0510P-152-D (1.5K)	B	33.7/107
R121	7030008280	S.RES ERJ2GEJ 271 X (270)	B	27.3/108.7
R122	7030004970	S.RES ERJ2GEJ 470 X (4.7K)	B	56.6/33.9
R123	7030004970	S.RES ERJ2GEJ 470 X (4.7K)	B	49.5/38.5
R124	7030005240	S.RES ERJ2GEJ 473 X (47K)	B	55.3/38.3
R125	7030008280	S.RES ERJ2GEJ 271 X (270)	B	84.7/46.2
R126	7030007290	S.RES ERJ2GEJ 222 X (2.2K)	B	96.5/42.6
R127	7030005720	S.RES ERJ2GEJ 563 X (56K)	T	88.4/58.4
R128	7030007290	S.RES ERJ2GEJ 222 X (2.2K)	T	33.4/108.3
R129	7030005240	S.RES ERJ2GEJ 473 X (47K)	B	55.3/35.1
R130	7030005240	S.RES ERJ2GEJ 473 X (47K)	B	56.2/36.7
R131	7030004980	S.RES ERJ2GEJ 101 X (100)	B	54.2/32.4
R132	7030007290	S.RES ERJ2GEJ 222 X (2.2K)	B	50.8/34.9
R133	7030007280	S.RES ERJ2GEJ 331 X (330)	B	67.5/104.4
R134	7030007270	S.RES ERJ2GEJ 151 X (150)	B	62.4/97.1
R136	7030005110	S.RES ERJ2GEJ 224 X (220K)	B	81.8/65.5
R137	7030005110	S.RES ERJ2GEJ 224 X (220K)	B	81.8/57
R138	7030005240	S.RES ERJ2GEJ 473 X (47K)	T	95.3/65.8
R139	7030005060	S.RES ERJ2GEJ 333 X (33K)	T	95.3/64.9
R140	7030007300	S.RES ERJ2GEJ 332 X (3.3K)	B	63.9/100.3
R141	7030005060	S.RES ERJ2GEJ 333 X (33K)	T	95.3/64
R142	7030007300	S.RES ERJ2GEJ 332 X (3.3K)	B	65.4/102.5
R143	7030005240	S.RES ERJ2GEJ 473 X (47K)	B	48.6/38.5
R144	7030005240	S.RES ERJ2GEJ 473 X (47K)		

[MAIN UNIT]

REF NO.	PARTS NO.	DESCRIPTION	M.	H/V LOCATION
R171	7030011920	S.RES RR0510P-561-D (560)	B	41.7/123.2
R172	7030009820	S.RES RR0510P-681-D (680)	B	97.4/65
R173	7030009820	S.RES RR0510P-681-D (680)	B	97.2/53.7
R174	7030009820	S.RES RR0510P-681-D (680)	B	42.1/113.8
R175	7030005530	S.RES ERJ2GEJ 100 X (10)	B	73.6/111
R176	7030005090	S.RES ERJ2GEJ 104 X (100K)	B	100.6/56.8
R177	7030005090	S.RES ERJ2GEJ 104 X (100K)	B	44.9/115.6
R178	7030004980	S.RES ERJ2GEJ 101 X (100)	B	100.6/55.9
R179	7030004980	S.RES ERJ2GEJ 101 X (100)	B	44.9/114.7
R180	7030005050	S.RES ERJ2GEJ 103 X (10K)	T	37/108.3
R181	7030005050	S.RES ERJ2GEJ 103 X (10K)	B	96.4/49
R184	7030008280	S.RES ERJ2GEJ 271 X (270)	B	63.2/119.1
R185	7030010090	S.RES ERJ2GEJ 180 X (18)	B	62.3/117.5
R186	7030005120	S.RES ERJ2GEJ 102 X (1K)	T	39.2/50.7
R187	7030008010	S.RES ERJ2GEJ 123 X (12K)	T	41.5/55.9
R188	7410001150	S.ARR EXB28V471JX	T	48.5/41.1
R189	7030005090	S.RES ERJ2GEJ 104 X (100K)	T	55.6/39.5
R190	7030008010	S.RES ERJ2GEJ 123 X (12K)	T	43.1/55.9
R191	7030005000	S.RES ERJ2GEJ 471 X (470)	B	43.5/112.2
R192	7030005110	S.RES ERJ2GEJ 224 X (220K)	B	44.4/112.2
R193	7030008280	S.RES ERJ2GEJ 271 X (270)	B	59.6/116.8
R194	7030004980	S.RES ERJ2GEJ 101 X (100)	B	99.2/53
R195	7030005110	S.RES ERJ2GEJ 224 X (220K)	B	100.1/53
R196	7030009320	S.RES ERJ2GEJ 4R7 X (4.7)	B	48/120.7
R197	7030005050	S.RES ERJ2GEJ 103 X (10K)	T	40.5/50.6
R198	7030009320	S.RES ERJ2GEJ 4R7 X (4.7)	B	103.7/62
R199	7030005050	S.RES ERJ2GEJ 103 X (10K)	T	67.6/57.5
R200	7030004980	S.RES ERJ2GEJ 101 X (100)	B	43.1/123.1
R201	7030005090	S.RES ERJ2GEJ 104 X (100K)	B	48/122.6
R202	7030005160	S.RES ERJ2GEJ 105 X (1M)	T	41.4/48.6
R204	7030005050	S.RES ERJ2GEJ 103 X (10K)	T	54.7/39.5
R205	7030008010	S.RES ERJ2GEJ 123 X (12K)	T	36.5/57.9
R207	7030005090	S.RES ERJ2GEJ 104 X (100K)	B	103.7/64
R208	7030010040	S.RES ERJ2GEJ-JPW	B	46.2/120.7
R209	7030005000	S.RES ERJ2GEJ 471 X (470)	T	67.6/56.5
R212	7410001140	S.ARR EXB28V471JX	T	52.3/41.1
R213	7030005530	S.RES ERJ2GEJ 100 X (10)	T	41.4/47.7
R214	7030004980	S.RES ERJ2GEJ 101 X (100)	B	98.9/64
R215	7030010040	S.RES ERJ2GEJ-JPW	B	100.9/62
R216	7410001140	S.ARR EXB28V104JX	T	17.3/52.4
R217	7410001140	S.ARR EXB28V104JX	T	38.6/56
R218	7030005090	S.RES ERJ2GEJ 104 X (100K)	B	61.4/138.5
R220	7410001140	S.ARR EXB28V104JX	T	15.2/50.7
R222	7410001140	S.ARR EXB28V104JX	T	36.1/56
R223	7030005050	S.RES ERJ2GEJ 103 X (10K)	B	61.4/137.6
R224	7410001150	S.ARR EXB28V471JX	T	30.4/53.1
R225	7030005090	S.RES ERJ2GEJ 104 X (100K)	B	61.4/139.4
R226	7030005110	S.RES ERJ2GEJ 224 X (220K)	B	39.9/72.7
R227	7410001150	S.ARR EXB28V471JX	T	42.9/28.9
R230	7410001150	S.ARR EXB28V471JX	T	28.6/50.9
R231	7030005000	S.RES ERJ2GEJ 471 X (470)	B	58.2/139.4
R232	7410001150	S.ARR EXB28V471JX	T	25.9/49.4
R233	7030004980	S.RES ERJ2GEJ 101 X (100)	B	58.2/135.8
R234	7410001150	S.ARR EXB28V471JX	T	42.5/25.7
R235	7410001150	S.ARR EXB28V471JX	T	24.2/47.6
R236	7030005090	S.RES ERJ2GEJ 104 X (100K)	B	132.4/82.7
R237	7030005530	S.RES ERJ2GEJ 100 X (10)	B	49.4/138.8
R238	7410001150	S.ARR EXB28V471JX	T	45.7/28.9
R239	7410001150	S.ARR EXB28V471JX	T	22.4/45.8
R240	7030004980	S.RES ERJ2GEJ 101 X (100)	B	134.7/86.7
R241	7030004990	S.RES ERJ2GEJ 221 X (2.2K)	B	49.4/134.3
R242	7030009320	S.RES ERJ2GEJ 4R7 X (4.7)	B	48.4/138.8
R243	7030005090	S.RES ERJ2GEJ 104 X (100K)	B	47.4/138.8
R244	7410001150	S.ARR EXB28V471JX	T	39.7/25.8
R245	7410001150	S.ARR EXB28V471JX	T	20.2/42.4
R246	7030005310	S.RES ERJ2GEJ 124 X (120K)	B	45.6/136.6
R247	7030005720	S.RES ERJ2GEJ 563 X (56K)	B	48.4/140.4
R249	7030008010	S.RES ERJ2GEJ 123 X (12K)	B	135.6/88.4
R250	7030004980	S.RES ERJ2GEJ 101 X (100)	B	133.8/90.1
R251	7030006610	S.RES ERJ2GEJ 394 X (390K)	B	49.4/142.5
R252	7030010040	S.RES ERJ2GEJ-JPW	B	132/86.7
R253	7030004970	S.RES ERJ2GEJ 470 X (47)	B	136.5/90.1
R255	7030005040	S.RES ERJ2GEJ 472 X (4.7K)	B	52.4/142.5
R256	7030005040	S.RES ERJ2GEJ 472 X (4.7K)	B	137.7/90.1
R257	7410001140	S.ARR EXB28V104JX	T	14.5/45.7
R259	7030005170	S.RES ERJ2GEJ 474 X (470K)	B	57.1/142.5
R260	7030007290	S.RES ERJ2GEJ 222 X (2.2K)	B	108.8/25.3
R261	7030005050	S.RES ERJ2GEJ 103 X (10K)	T	52.5/25.2
R262	7030005090	S.RES ERJ2GEJ 104 X (100K)	T	51.9/22.8
R263	7410001140	S.ARR EXB28V104JX	T	46.2/20
R264	7410001140	S.ARR EXB28V104JX	T	50.2/24
R265	7030010040	S.RES ERJ2GEJ-JPW	B	87.1/43.5
R267	7410001140	S.ARR EXB28V104JX	T	15/42.5
R268	7410001150	S.ARR EXB28V471JX	T	45.7/31.8
R269	7030004980	S.RES ERJ2GEJ 101 X (100)	B	143.2/94.7
R270	7030005050	S.RES ERJ2GEJ 103 X (10K)	B	36/136.6
R271	7030005090	S.RES ERJ2GEJ 104 X (100K)	T	23.8/26.7
R272	7410001150	S.ARR EXB28V471JX	T	17.9/32.3
R273	7410001150	S.ARR EXB28V471JX	T	17.9/35.1
R274	7030005090	S.RES ERJ2GEJ 104 X (100K)	B	36/137.5
R275	7030005060	S.RES ERJ2GEJ 333 X (33K)	T	93.1/55.7
R276	7030010040	S.RES ERJ2GEJ-JPW	B	147.1/44.4
R277	7030004980	S.RES ERJ2GEJ 101 X (100)	T	85/126
R278	7030005090	S.RES ERJ2GEJ 104 X (100K)	T	13.9/65.6
R279	7030007290	S.RES ERJ2GEJ 222 X (2.2K)	T	102.4/90.1
R280	7030004990	S.RES ERJ2GEJ 221 X (220)	T	141.3/127.7
R281	7410001150	S.ARR EXB28V471JX	T	21.3/31.8
R282	7030005090	S.RES ERJ2GEJ 104 X (100K)	T	37.8/20.3
R283	7030005100	S.RES ERJ2GEJ 154 X (150K)	T	144/124.4
R285	7030005050	S.RES ERJ2GEJ 103 X (10K)	T	101.6/79.5
R286	7030005080	S.RES ERJ2GEJ 823 X (82K)	B	40.8/72.7
R287	7410001140	S.ARR EXB28V104JX	T	49.7/27.7
R288	7030007340	S.RES ERJ2GEJ 153 X (15K)	T	139.5/122.5
R289	7030006070	S.RES ERJ12V101U (100)	B	86.9/117.5
R290	7030005050	S.RES ERJ2GEJ 103 X (10K)	T	138.6/122.5

[MAIN UNIT]

REF NO.	PARTS NO.	DESCRIPTION	M.	H/V LOCATION
R291	7030005040	S.RES ERJ2GEJ 472 X (4.7K)	T	137.6/127.7
R292	7030005050	S.RES ERJ2GEJ 103 X (10K)	T	144/126
R293	7030004980	S.RES ERJ2GEJ 101 X (100)	B	136.5/83.3
R294	7030004980	S.RES ERJ2GEJ 101 X (100)	B	136.5/85
R295	7030005090	S.RES ERJ2GEJ 104 X (100K)	T	137.6/122.5
R296	7030000440	S.RES MCR10EZHJ 3.3K (332)	T	118.4/79.6
R297	7030000440	S.RES MCR10EZHJ 3.3K (332)	T	120.2/79.6
R298	7030000440	S.RES MCR10EZHJ 3.3K (332)	T	116.6/79.6
R299	7030004980	S.RES ERJ2GEJ 101 X (100)	B	29.1/19.4
R300	7030005530	S.RES ERJ2GEJ 100 X (10)	T	47.6/73.1
R301	7030008300	S.RES ERJ2GEJ 184 X (180K)	B	85.6/105.6
R302	7030005590	S.RES ERJ2GEJ 680 X (68)	B	135.6/85
R303	7410001150	S.ARR EXB28V471JX	T	47.7/68.4
R304	7030005050	S.RES ERJ2GEJ 103 X (10K)	B	84.3/130
R306	7520000260	S.POS PRF18BB471QB1RB	B	84.4/104.4
R308	7030005060	S.RES ERJ2GEJ 333 X (33K)	T	144/127.7
	7030005060	S.RES ERJ2GEJ 333 X (33K)	[USA-01]	
	7030005070	S.RES ERJ2GEJ 683 X (68K)	[EXP-01]	
	7030005070	S.RES ERJ2GEJ 683 X (68K)	[EUR-01]	
R309	7030005040	S.RES ERJ2GEJ 472 X (4.7K)	T	102.2/75.7
R310	7030005030	S.RES ERJ2GEJ 152 X (1.5K)	T	143.3/120.2
R311	7030008410	S.RES ERJ2GEJ 392 X (3.9K)	T	145/122.5
R312	7030005050	S.RES ERJ2GEJ 103 X (10K)	T	146.8/120.2
R313	7030005050	S.RES ERJ2GEJ 103 X (10K)	T	103.5/77.8
R314	7030007280	S.RES ERJ2GEJ 331 X (330)	T	146/124.4
R315	7030005700	S.RES ERJ2GEJ 274 X (270K)	B	86/128.9
R316	7030005050	S.RES ERJ2GEJ 103 X (10K)	T	11.2/128.2
R317	7030005010	S.RES ERJ2GEJ 681 X (680)	B	138.5/94.7
R318	7030003260	S.RES ERJ3GEYJ 330 V (33)	B	140.2/90.1
R320	7030005090	S.RES ERJ2GEJ 104 X (100K)	T	15/124.1
R321	7030003370	S.RES ERJ3GEYJ 271 V (270)	B	119.6/141.7
R322	7030005600	S.RES ERJ2GEJ 273 X (27K)	B	121.5/143.4
R324	7030005050	S.RES ERJ2GEJ 103 X (10K)	B	31.3/12
R325	7030005120	S.RES ERJ2GEJ 102 X (1K)	B	32.3/12
R326	7030005240	S.RES ERJ2GEJ 473 X (47K)	T	13.2/125.7
R327	7030000260	S.RES MCR10EZHJ 100 (101)	B	119.7/132.8
R328	7030000280	S.RES MCR10EZHJ 150 (151)	B	139.3/143.3
R331	7030004980	S.RES ERJ2GEJ 101 X (100)	T	12/120
R332	7030003370	S.RES ERJ3GEYJ 271 V (270)	B	139.5/136
R333	7030005600	S.RES ERJ2GEJ 273 X (27K)	B	137.7/131.9
R334	7030005651	S.RES ERA3YKD 304V (300K)	T	57.8/30.5
R335	7030005871	S.RES ERA3YKD 104V (100K)	T	55.9/29.7
R336	7030005110	S.RES ERJ2GEJ 224 X (220K)	T	12/120.9
R337	7030005110	S.RES ERJ2GEJ 224 X (220K)	T	13.2/120.6
R339	7030005090	S.RES ERJ2GEJ 104 X (100K)	T	12/125.3
R341	7030005050	S.RES ERJ2GEJ 103 X (10K)	B	33.3/12
R342	7030005090	S.RES ERJ2GEJ 104 X (100K)	B	45.3/56.9
R346	7410001150	S.ARR EXB28V471JX	T	43.5/73.8
R347	7030005000	S.RES ERJ2GEJ 471 X (470)	T	9.8/132.9
R348	7030000620	S.RES MCR10EZHJ 100 K (104)	B	147.2/150.9
R349	7030000620	S.RES MCR10EZHJ 100 K (104)	B	26/149.7
R350	7030003560	S.RES ERJ3GEYJ 103 V (10K)	B	6.4/131
R352	7030005040	S.RES ERJ2GEJ 472 X (4.7K)	T	10.7/125.5
R353	7030005240	S.RES ERJ2GEJ 473 X (47K)	B	55.8/56.9
R354	7030005700	S.RES ERJ2GEJ 274 X (270K)	T	123.3/103
R355	7030005090	S.RES ERJ2GEJ 104 X (100K)	T	127.4/102.2
R356	7030005050	S.RES ERJ2GEJ 103 X (10K)	T	9.8/134.5
R357	7030003560	S.RES ERJ3GEYJ 103 V (10K)	B	10.1/150.2
R362	7540000290	ABS ERZV10D220	T	65.1/71.2
R364	7030005110	S.RES ERJ2GEJ 224 X (220K)	T	7.4/120.7
R365	7030005050	S.RES ERJ2GEJ 103 X (10K)	T	6.2/122.7
R366	7030007290	S.RES ERJ2GEJ 221 X (2.2K)	T	9.7/117.3
R367	7030004980	S.RES ERJ2GEJ 101 X (100)	T	8.5/117.8
R368	7030008300	S.RES ERJ2GEJ 184 X (180K)	T	9.7/118.2
R369	7030005230	S.RES ERJ2GEJ 334 X (330K)	T	6.1/120.7
R370	7030008280	S.RES ERJ2GEJ 271 X (270)	T	5/117.3
R371	7030010040	S.RES ERJ2GEJ-JPW	T	115.3/15.8
R372	7030005000	S.RES ERJ2GEJ 471 X (470)	T	115.3/14
R373	7030005050	S.RES ERJ2GEJ 103 X (10K)	T	11.2/12.3
R374	7030000140	S.RES MCR10EZHJ 100 (100)	T	100.1/16.3
R375	7030010040	S.RES ERJ2GEJ-JPW	B	62.3/122.2
R376	7030004980	S.RES ERJ2GEJ 101 X (100)	B	63.2/126.1
R378	7030005210	S.RES ERJ2GEJ 822 X (8.2K)	B	59.6/126.1
R379	7030005210	S.RES ERJ2GEJ 822 X (8.2K)	B	57.8/123.7
R380	7030007260	S.RES ERJ2GEJ 330 X (33)	B	61.4/126.1
R381	7030005570	S.RES ERJ2GEJ 820 X (82)	T	46.3/42.9
R424	7410001150	S.ARR EXB28V471JX	T	36.8/23

[MAIN UNIT]

REF NO.	PARTS NO.	DESCRIPTION	M.	H/V LOCATION
R471	7030005090	S.RES ERJ2GEJ 104 X (100K)	B	47.7/44.2
R472	7030005240	S.RES ERJ2GEJ 473 X (47K)	B	4.8/36.1
R473	7030005090	S.RES ERJ2GEJ 104 X (100K)	B	46.2/44.6
R474	7030005530	S.RES ERJ2GEJ 100 X (10)	B	15.5/55.3
R475	7030005000	S.RES ERJ2GEJ 471 X (470)	B	9/56.2
R476	7030005090	S.RES ERJ2GEJ 104 X (100K)	B	15/53.5
R477	7030005080	S.RES ERJ2GEJ 823 X (82K)	B	15/52.6
R478	7030005050	S.RES ERJ2GEJ 103 X (10K)	B	9.1/54.7
R479	7030005110	S.RES ERJ2GEJ 224 X (220K)	T	64.2/69.6
R480	7030005050	S.RES ERJ2GEJ 103 X (10K)	B	15.6/61.5
R481	7030005050	S.RES ERJ2GEJ 103 X (10K)	B	16.5/59.9
R482	7410001150	S.ARR EXB28V471JX	T	19.6/45.1
R483	7030005090	S.RES ERJ2GEJ 104 X (100K)	T	31.2/56.5
R484	7030005090	S.RES ERJ2GEJ 104 X (100K)	B	28.8/50.9
R485	7410001150	S.ARR EXB28V471JX	T	67.3/96.9
R486	7410001150	S.ARR EXB28V471JX	T	63.9/107
R487	7410001150	S.ARR EXB28V471JX	T	73.1/106.9
R488	7030005000	S.RES ERJ2GEJ 471 X (470)	T	9.5/54.9
R489	7030004980	S.RES ERJ2GEJ 101 X (100)	B	24.1/58.7
R490	7030008290	S.RES ERJ2GEJ 183 X (18K)	B	28.2/58.4
R491	7030004980	S.RES ERJ2GEJ 101 X (100)	B	26.1/51.2
R492	7030005240	S.RES ERJ2GEJ 473 X (47K)	B	29.8/58.8
R493	7030010040	S.RES ERJ2GEJ-JPW	T	11.3/19
R494	7030005000	S.RES ERJ2GEJ 471 X (470)	T	73.3/99
R495	7030008270	S.RES RR0510P-104-D (100K)	T	54.9/55.3
R496	7030006020	S.RES RR0510P-682-D (6.8K)	T	52.7/56.2
R497	7030008250	S.RES RR0510P-562-D (5.6K)	T	52.7/55.3
R498	7030005600	S.RES ERJ2GEJ 273 X (27K)	B	61.4/103.1
R499	7030004980	S.RES ERJ2GEJ 101 X (100)	T	24.4/57
R500	7030005600	S.RES ERJ2GEJ 273 X (27K)	T	21.2/57.5
R501	7030005220	S.RES ERJ2GEJ 223 X (22K)	T	22.8/53.8
R502	7030005090	S.RES ERJ2GEJ 104 X (100K)	T	28/55
R503	7030007350	S.RES ERJ2GEJ 393 X (39K)	T	55.6/58.9
R504	7030011920	S.RES RR0510P-561-D (56K)	T	52.7/54.4
R505	7030010040	S.RES ERJ2GEJ-JPW	T	113.4/18.3
R506	7030005110	S.RES ERJ2GEJ 224 X (220K)	T	113.4/19.3
R507	7030005090	S.RES ERJ2GEJ 104 X (100K)	T	115/19.3
R508	7030010040	S.RES ERJ2GEJ-JPW	B	93.7/42.6
R509	7030005050	S.RES ERJ2GEJ 103 X (10K)	B	33.3/15.2
R510	7030007350	S.RES ERJ2GEJ 393 X (39K)	B	29/14.1
R511	7030005050	S.RES ERJ2GEJ 103 X (10K)	B	29.1/18.5
R512	7030005050	S.RES ERJ2GEJ 103 X (10K)	B	30.8/18.5
R513	7030007280	S.RES ERJ2GEJ 331 X (33K)	B	72.6/91
R530	7030005240	S.RES ERJ2GEJ 473 X (47K)	T	62.5/66.3
R532	7030005000	S.RES ERJ2GEJ 471 X (470)	B	45.1/37.1
R533	7030005090	S.RES ERJ2GEJ 104 X (100K)	T	57.2/18.4
R534	7030005600	S.RES ERJ2GEJ 273 X (27K)	B	45.3/58.6
R535	7030004980	S.RES ERJ2GEJ 101 X (100)	B	56.7/56.9
R536	7030005600	S.RES ERJ2GEJ 273 X (27K)	B	55.8/58.6
R537	7030010040	S.RES ERJ2GEJ-JPW	B	41.6/41.2
R539	7030005110	S.RES ERJ2GEJ 224 X (220K)	T	64.2/71.2
R540	7030005090	S.RES ERJ2GEJ 104 X (100K)	T	90.6/17.9
R541	7030005220	S.RES ERJ2GEJ 223 X (22K)	T	28.9/55
R542	7030005120	S.RES ERJ2GEJ 102 X (1K)	T	70.4/65.1
R545	7030010040	S.RES ERJ2GEJ-JPW	T	61.2/98.7
R546	7030010040	S.RES ERJ2GEJ-JPW	T	61.2/99.6
R547	7030010040	S.RES ERJ2GEJ-JPW	T	69.7/99.1
R548	7030009140	S.RES ERJ2GEJ 272 X (2.7K)	B	38.7/139
C1	4030017420	S.CER ECJ0EC1H470J	B	120.7/39
C2	4030017420	S.CER ECJ0EC1H470J	B	22.9/78.1
C3	4030016930	S.CER ECJ0EB1A104K	B	130.8/50.2
C4	4030017420	S.CER ECJ0EC1H470J	B	121.9/37.1
C5	4030017420	S.CER ECJ0EC1H470J	B	21.7/77.1
C6	4030016930	S.CER ECJ0EB1A104K	B	52.4/77.9
C7	4030017420	S.CER ECJ0EC1H470J	B	122.8/37.1
C8	4030017420	S.CER ECJ0EC1H470J	B	21.7/75.5
C9	4030017460	S.CER ECJ0EB1E102K	T	17.6/59
C10	4030016930	S.CER ECJ0EB1A104K	B	55.7/77.9
C11	4030016930	S.CER ECJ0EB1A104K	B	123.7/37.1
C12	4030016930	S.CER ECJ0EB1A104K	B	22.1/74.3
C13	4030016930	S.CER ECJ0EB1A104K	B	55.6/80.7
C14	4030017460	S.CER ECJ0EB1E102K	T	16.1/59.9
C15	4030016930	S.CER ECJ0EB1A104K	T	62.4/67.5
C16	4030017620	S.CER ECJ0EC1H100C	T	56.1/64.5
C17	4030016930	S.CER ECJ0EB1A104K	B	115.5/40.6
C18	4030017430	S.CER ECJ0EC1H101J	T	62.4/71.2
C19	4030016930	S.CER ECJ0EB1A104K	B	22.9/80.3
C20	4550006250	S.TAN TEESVA 1A 106M8R	B	115.3/37.5
C21	4550006250	S.TAN TEESVA 1A 106M8R	B	21.3/80.5
C22	4030016930	S.CER ECJ0EB1A104K	B	50/77.9
C23	4030016930	S.CER ECJ0EB1A104K	T	57.8/52.6
C24	4030016930	S.CER ECJ0EB1A104K	B	50.3/81.1
C25	4030016930	S.CER ECJ0EB1A104K	B	54.4/81.1
C26	4030017460	S.CER ECJ0EB1E102K	B	117.8/39.2
C27	4030017460	S.CER ECJ0EB1E102K	B	23.8/80.3
C28	4030016930	S.CER ECJ0EB1A104K	B	53.3/77.9
C30	4030017460	S.CER ECJ0EB1E102K	T	59.8/67
C31	4030016930	S.CER ECJ0EB1A104K	T	60.5/53
C32	4030017590	S.CER ECJ0EC1H070C	B	38.4/79.1
C33	4030016930	S.CER ECJ0EB1A104K	T	58.9/67
C34	4030017570	S.CER ECJ0EC1H040B	B	37.2/78.7
C35	4030016930	S.CER ECJ0EB1A104K	B	35.8/75.7
C36	4030017500	S.CER ECJ0EC1H560J	B	37.2/79.6
C37	4030016930	S.CER ECJ0EB1A104K	B	48.4/79.8
C38	4030016930	S.CER ECJ0EB1A104K	B	69.8/78.2
C39	4030017360	S.CER ECJ0EC1H030B	B	71.4/77.3
C40	4030017690	S.CER ECJ0EC1H121J	B	68.2/76.4
C41	4030018860	S.CER ECJ0EB0J105K	B	31/58.2
C42	4030017690	S.CER ECJ0EC1H121J	B	66.4/78.2
C43	4030016930	S.CER ECJ0EB1A104K	B	55.6/49
C44	4030018860	S.CER ECJ0EB0J105K	B	35.7/56.4
C45	4030016950	S.CER ECJ0EB1A473K	B	34.5/55.2
C47	4030017460	S.CER ECJ0EB1E102K	B	64.6/77.3

[MAIN UNIT]

REF NO.	PARTS NO.	DESCRIPTION	M.	H/V LOCATION
C48	4030016930	S.CER ECJ0EB1A104K	T	54.3/54.4
C49	4030018860	S.CER ECJ0EB0J105K	B	15.6/58.3
C50	4030016930	S.CER ECJ0EB1A104K	B	130.8/48.4
C51	4030017620	S.CER ECJ0EC1H100C	B	125.1/45.6
C52	4030017420	S.CER ECJ0EC1H470J	B	120.6/48.8
C53	4030017420	S.CER ECJ0EC1H470J	B	32.7/78.4
C54	4030017620	S.CER ECJ0EC1H330J	B	32.7/77.3
C56	4030016950	S.CER ECJ0EB1A473K	B	31.9/59.1
C59	4030017430	S.CER ECJ0EC1H101J	B	32.7/75.5
C60	4030017620	S.CER ECJ0EC1H100C	B	32.3/72.7
C61	4030018900	S.CER ECJ0EB0J474K	B	18/63.8
C62	4030016930	S.CER ECJ0EB1A104K	B	33.6/55.2
C63	4030016930	S.CER ECJ0EB1A104K	T	55.6/62.1
C64	4030017460	S.CER ECJ0EB1E102K	B	33.2/104.3
C66	4030017430	S.CER ECJ0EC1H101J	B	123.5/48.4
C67	4030017460	S.CER ECJ0EB1E102K	B	67.5/87.7
C69	4030016930	S.CER ECJ0EB1A104K	B	29.8/63
C70	4030017460	S.CER ECJ0EB1E102K	B	64.3/79.4
C71	4030016930	S.CER ECJ0EB1A104K	B	57.6/43.3
C72	4030018910	S.CER C1608 JB 0J 475K-T	B	29.3/61.9
C73	4030017460	S.CER ECJ0EB1E102K	B	93.7/46.2
C74	4030017780	S.CER ECJ0EB1E472K	B	93.7/40.7
C75	4030017460	S.CER ECJ0EB1E102K	B	39.6/106.1
C76	4030017780	S.CER ECJ0EB1E472K	B	29.9/98.3
C77	4030016930	S.CER ECJ0EB1A104K	T	53.9/57.7
C78	4030017460	S.CER ECJ0EB1E102K	B	118.7/48.8
C79	4030017460	S.CER ECJ0EB1E102K	B	34.3/79.5
C80	4030017380	S.CER ECJ0EC1H050B	B	102.4/44.5
C81	4030017380	S.CER ECJ0EC1H050B	B	44/101.1
C82	4550006250	S.TAN TEESVA 1A 106M8R	B	61.1/79.2
C83	4030017460	S.CER ECJ0EB1E102K	B	71.7/86.7
C84	4030017420	S.CER ECJ0EC1H470J	B	74.7/81.1
C85	4030017590	S.CER ECJ0EC1H070C	B	56/43.3
C86	4030016930	S.CER ECJ0EB1A104K	B	51.7/47.1
C87	4030018910	S.CER C1608 JB 0J 475K-T	B	54.3/48.4
C88	4030017780	S.CER ECJ0EB1E472K	B	92.1/40.7
C89	4030017780	S.CER ECJ0EB1E472K	B	28.3/99.3
C90	4030017680	S.CER ECJ0EC1H820J	B	69.1/86.7
C91	4030016930	S.CER ECJ0EB1A104K	T	60.7/66.3
C92	4030016930	S.CER ECJ0EB1C103K	B	72.7/88
C93	4030017460	S.CER ECJ0EB1E102K	B	70.5/87.2
C94	4030017350	S.CER ECJ0EC1H020B	B	103.2/47.6
C96	4030018910	S.CER C1608 JB 0J 475K-T	B	49.2/48.9
C97	4030016930	S.CER ECJ0EB1A104K	B	57.4/50.6
C98	4030017460	S.CER ECJ0EB1E102K	B	36.4/105.2
C99	4030017460	S.CER ECJ0EB1E102K	B	40.8/71.1
C100	4030017460	S.CER ECJ0EB1E102K	B	84.7/48
C101	4030017620	S.CER ECJ0EC1H100C	B	37.7/63.2
C102	4550007650	S.TAN F931V105MAABMA	B	88.7/41
C103	4550007650	S.TAN F931V105MAABMA	B	26.2/100.3
C104	4030016930	S.CER ECJ0EB1A104K	B	39.9/74.3
C105	4030017580	S.CER ECJ0EC1H060C	B	103.2/46.7
C106	4030017350	S.CER ECJ0EC1H020B	B	47/102.2
C107	4030017590	S.CER ECJ0EC1H070C	B	72.3/90
C108	4030017460	S.CER ECJ0EB1E102K	B	87.1/48
C109	4030017380	S.CER ECJ0EC1H050B	B	101.9/47.2
C110	4030017360	S.CER ECJ0EC1H030B	B	46.5/103.5
C111	4030016790	S.CER ECJ0EB1C103K	B	71/93.8
C112	4550007650	S.TAN F931V105MAABMA	B	83.6/41
C113	4550007650	S.TAN F931V105MAABMA	B	28.3/105.6
C114	4030017580	S.CER ECJ0EC1H060C	B	103.2/48.5
C115	4030017350	S.CER ECJ0EC1H020B	B	47/104.9
C116	4030017460	S.CER ECJ0EB1E102K	B	71/91
C117	4030016790	S.CER ECJ0EB1C103K	B	73.5/95.7
C118	4030016790	S.CER ECJ0EB1C103K	B	71/92
C119	4030017350	S.CER ECJ0EC1H020B	B	103.2/49.4
C121	4030016790	S.CER ECJ0EB1C103K	B	71/94.8
C122	4030016790	S.CER ECJ0EB1C103K	B	69.1/90.1
C123	4030016930	S.CER ECJ0EB1A104K	B	67.4/98.3
C124	4030016930	S.CER ECJ0EB1A104K	B	48.5/50.5
C125	4030016790	S.CER ECJ0EB1C103K	B	98.1/42.6
C126	4030016790	S.CER ECJ0EB1C103K	B	57.2/35.1
C127	4030016790	S.CER ECJ0EB1C103K	T	32.4/108.3
C133	4030017590	S.CER ECJ0EC1H070C	B	59.6/92
C134	4550003250	S.TAN TEESVA 1V 474M8R	B	26.2/105.6
C135	4030016930	S.CER ECJ0EB1A104K	B	30.8/110.6
C136	4030016930	S.CER ECJ0EB1A104K	B	50.4/36.8
C137	4030017620	S.CER ECJ0EC1H100C	B	56.2/38.3
C138	4030017640	S.CER ECJ0EC1H150J	B	75.8/101.1
C139	4030017650	S.CER ECJ0EC1H270J	B	59.6/90.3
C140	4030016930	S.CER ECJ0EB1A104K	B	55.3/36.7
C141	4550003250	S.TAN TEESVA 1V 474M8R	B	81.9/44.6
C144	4550006250	S.TAN TEESVA 1A 106M8R	B	98.3/41
C145	4030017420	S.CER ECJ0EC1H470J	B	50.4/38.5
C146	4030017460	S.CER ECJ0EB1E102K	B	56.2/35.1
C147	4550006250	S.T		

[MAIN UNIT]

REF NO.	PARTS NO.	DESCRIPTION	M.	H/V LOCATION
C168	4030017400	S.CER ECJ0EC1H220J	B	29.9/122.2
C169	4030018070	S.CER ECJ0EC1H300J	B	30.8/122.2
C170	4030018070	S.CER ECJ0EC1H300J	B	28.7/114.6
C171	4030017390	S.CER ECJ0EC1H180J	B	28.7/113.7
C172	4030017510	S.CER ECJ0EC1H680J	B	85.8/63.9
C173	4030017550	S.CER ECJ0EC1H1R5B	B	93/66.4
C174	4030017420	S.CER ECJ0EC1H470J	B	84.4/54.1
C175	4030017460	S.CER ECJ0EB1E102K	T	93.1/53.9
C176	4030018860	S.CER ECJ0EB0J105K	B	90.9/57.7
C177	4030017600	S.CER ECJ0EC1H080C	B	36.7/123.3
C178	4030017600	S.CER ECJ0EC1H080C	B	37.6/111.1
C179	4030017420	S.CER ECJ0EC1H470J	T	14.9/129.1
C180	4030017640	S.CER ECJ0EC1H150J	B	91.7/65
C181	4030017400	S.CER ECJ0EC1H220J	B	83.4/54.1
C182	4030016790	S.CER ECJ0EB1C103K	B	63.1/104.4
C183	4030017420	S.CER ECJ0EC1H470J	T	14.9/131.3
C184	4030017670	S.CER ECJ0EC1H390J	B	37.9/124.9
C185	4030018010	S.CER ECJ0EC1H360J	B	37.6/115.6
C186	4030017420	S.CER ECJ0EC1H470J	T	93.1/57.7
C187	4030017420	S.CER ECJ0EC1H470J	T	95.3/67.6
C188	4030017650	S.CER ECJ0EC1H270J	B	84.9/63.9
C189	4030017620	S.CER ECJ0EC1H100C	B	93.1/51.4
C190	4030017550	S.CER ECJ0EC1H1R5B	B	93.1/56.8
C191	4030017660	S.CER ECJ0EC1H330J	B	93/65.5
C192	4030017670	S.CER ECJ0EC1H390J	B	93.1/55.9
C193	4030017460	S.CER ECJ0EB1E102K	B	61.4/107.1
C194	4030017660	S.CER ECJ0EC1H330J	B	37.9/123.1
C195	4030017670	S.CER ECJ0EC1H390J	B	40.3/120.7
C196	4030018010	S.CER ECJ0EC1H360J	B	37.6/113.8
C197	4030017670	S.CER ECJ0EC1H390J	B	41.7/112.2
C198	4030016790	S.CER ECJ0EB1C103K	B	60.5/107.1
C199	4030017460	S.CER ECJ0EB1E102K	T	95.3/63.1
C200	4030017650	S.CER ECJ0EC1H270J	B	93/63.7
C201	4030017660	S.CER ECJ0EC1H330J	B	96/62
C202	4030017670	S.CER ECJ0EC1H390J	B	93.1/54.1
C203	4030017420	S.CER ECJ0EC1H470J	B	97.2/52.1
C204	4550006250	S.TAN TEESVA 1A 106M8R	T	81.6/17
C205	4550006250	S.TAN TEESVA 1A 106M8R	T	85.1/17
C206	4550006250	S.TAN TEESVA 1A 106M8R	T	88.5/17
C208	4030018860	S.CER ECJ0EB0J105K	T	80/17
C209	4030018860	S.CER ECJ0EB0J105K	T	83.5/17
C210	4030018860	S.CER ECJ0EB0J105K	T	86.9/17
C211	4030016930	S.CER ECJ0EB1A104K	B	38.5/120.7
C212	4030016790	S.CER ECJ0EB1C103K	B	39.9/112.2
C213	4030017650	S.CER ECJ0EC1H270J	B	68.5/106.1
C214	4030017460	S.CER ECJ0EB1E102K	B	66.8/107
C215	4030017540	S.CER ECJ0EC1HR75B	B	42.8/118.5
C216	4030017540	S.CER ECJ0EC1HR75B	B	42.8/116.9
C217	4030017460	S.CER ECJ0EB1E102K	B	39.4/120.7
C218	4030017460	S.CER ECJ0EB1E102K	B	40.8/112.2
C219	4030016790	S.CER ECJ0EB1C103K	B	94.2/62
C220	4030017530	S.CER ECJ0EC1H0R5B	B	98.5/59.6
C221	4030016790	S.CER ECJ0EB1C103K	B	95.4/52
C222	4030017530	S.CER ECJ0EC1H0R5B	B	99.4/56.6
C224	4030017460	S.CER ECJ0EB1E102K	B	95.1/62
C225	4030017460	S.CER ECJ0EB1E102K	B	96.3/52
C228	4030018860	S.CER ECJ0EB0J105K	T	78.6/24.6
C229	4030018860	S.CER ECJ0EB0J105K	T	83.2/24.9
C230	4030018860	S.CER ECJ0EB0J105K	T	86.8/24
C231	4550005980	S.TAN TEESVA 1A 475M8R	T	80.3/25.8
C232	4550005980	S.TAN TEESVA 1A 475M8R	T	84.8/26.2
C233	4550005980	S.TAN TEESVA 1A 475M8R	T	88.5/25.6
C235	4030017030	S.CER ECJ0EB1A273K	T	41/55
C236	4030017730	S.CER ECJ0EB1E471K	B	100.6/55
C237	4030017460	S.CER ECJ0EB1E102K	B	100.6/60.4
C238	4030017730	S.CER ECJ0EB1E471K	B	44.9/113.8
C239	4030017460	S.CER ECJ0EB1E102K	B	44.9/119.2
C240	4510009550	S.ELE EEEFK1C100R	T	95.1/22.3
C241	4030017350	S.CER ECJ0EC1H020B	B	68.3/120.9
C242	4030016790	S.CER ECJ0EB1C103K	B	68.7/111.2
C243	4030017460	S.CER ECJ0EB1E102K	B	70.3/106.1
C244	4030016790	S.CER ECJ0EB1C103K	B	70.3/107
C245	4030017460	S.CER ECJ0EB1E102K	T	94.8/60.2
C246	4030017620	S.CER ECJ0EC1H100C	B	46.9/114.7
C247	4030017460	S.CER ECJ0EB1E102K	B	42.6/112.2
C248	4030017460	S.CER ECJ0EB1E102K	B	36/117.8
C249	4030017420	S.CER ECJ0EC1H470J	B	48/112.2
C250	4030017590	S.CER ECJ0EC1H070C	B	103.7/58.7
C251	4030017620	S.CER ECJ0EC1H100C	B	102.6/55.9
C252	4030017460	S.CER ECJ0EB1E102K	B	99.2/51.3
C253	4030017590	S.CER ECJ0EC1H070C	B	48/117.4
C254	4030017460	S.CER ECJ0EB1E102K	B	103.7/53
C255	4030016930	S.CER ECJ0EB1A104K	T	42.1/50.6
C256	4030017640	S.CER ECJ0EC1H150J	T	43.1/55
C257	4030016790	S.CER ECJ0EB1C103K	T	36.5/58.8
C258	4030017390	S.CER ECJ0EC1H180J	B	59.6/117.8
C259	4030017580	S.CER ECJ0EC1H060C	T	48.5/46.4
C260	4030017460	S.CER ECJ0EB1E102K	B	46.5/107.5
C261	4030017460	S.CER ECJ0EB1E102K	B	47.7/110.3
C262	4030016930	S.CER ECJ0EB1A104K	T	69.2/57.5
C263	4030017460	S.CER ECJ0EB1E102K	B	60.5/126.1
C264	4030017460	S.CER ECJ0EB1E102K	B	101.9/48.9
C265	4030017460	S.CER ECJ0EB1E102K	B	43.5/120.7
C266	4030018900	S.CER ECJ0EB0J474K	T	43.7/45.6
C267	4030017660	S.CER ECJ0EC1H330J	B	59.6/119.3
C268	4030017460	S.CER ECJ0EB1E102K	B	62.3/126.1
C269	4550006780	S.TAN TEESVB2 0J 476M8R	T	72.2/60.8
C270	4030016930	S.CER ECJ0EB1A104K	T	40.5/49.7
C271	4030017610	S.CER ECJ0EC1H090C	B	70.7/137.8
C272	4030017630	S.CER ECJ0EC1H120J	T	47.3/60.1
C274	4030017460	S.CER ECJ0EB1E102K	B	44.4/120.7
C275	4030017620	S.CER ECJ0EC1H100C	B	48/124.9
C276	4030017600	S.CER ECJ0EC1H080C	B	71.9/139.9
C277	4030016790	S.CER ECJ0EB1C103K	T	48.6/36.7
C279	4030017390	S.CER ECJ0EC1H180J	B	59.6/120.9

[MAIN UNIT]

REF NO.	PARTS NO.	DESCRIPTION	M.	H/V LOCATION
C280	4030017460	S.CER ECJ0EB1E102K	B	98.9/66.3
C281	4030017460	S.CER ECJ0EB1E102K	B	100/62
C282	4030017630	S.CER ECJ0EC1H120J	B	61.4/122.2
C283	4030017620	S.CER ECJ0EC1H100C	B	103.7/65.9
C286	4030017570	S.CER ECJ0EC1H040B	B	61.4/140.3
C287	4030017350	S.CER ECJ0EC1H020B	B	58.2/138.5
C288	4030017570	S.CER ECJ0EC1H040B	B	64.1/139.8
C289	4030017600	S.CER ECJ0EC1H080C	B	71.9/135.7
C290	4030017600	S.CER ECJ0EC1H080C	B	70.7/139.5
C291	4030017340	S.CER ECJ0EC1H010B	B	102.4/66.6
C292	4030017460	S.CER ECJ0EB1E102K	B	61.4/136.7
C293	4030017570	S.CER ECJ0EC1H040B	B	44/100.2
C294	4030017360	S.CER ECJ0EC1H030B	B	47.7/108.1
C295	4030017460	S.CER ECJ0EB1E102K	B	61.4/135.8
C296	4030017200	S.CER GRM31BR32J102KY01L (GHM1030 R)	B	98.7/132.7
C297	4030017580	S.CER ECJ0EC1H060C	B	88.8/138.9
C298	4030017460	S.CER ECJ0EB1E102K	B	132.9/86.7
C299	4030017460	S.CER ECJ0EB1E102K	B	58.2/137.6
C300	4030017460	S.CER ECJ0EB1E102K	B	58.2/134.9
C301	4030016790	S.CER ECJ0EB1C103K	B	58.2/136.7
C302	4030017460	S.CER ECJ0EB1E102K	B	54.2/139.8
C303	4030017400	S.CER ECJ0EC1H220J	B	131.1/82.4
C304	4030017420	S.CER ECJ0EC1H470J	B	133.8/86.7
C305	4030017420	S.CER ECJ0EC1H470J	B	47.4/134.3
C306	4030017460	S.CER ECJ0EB1E102K	B	48.4/134.3
C307	4030017460	S.CER ECJ0EB1E102K	B	46.5/138.8
C309	4030016790	S.CER ECJ0EB1C103K	B	134.7/86.4
C310	4030017360	S.CER ECJ0EC1H120J	B	136.5/87.2
C311	4030016930	S.CER ECJ0EB1A104K	B	46.5/140.4
C312	4030016930	S.CER ECJ0EB1A104K	B	51.4/142.5
C313	4030016930	S.CER ECJ0EB1A104K	B	47.4/140.4
C314	4030017460	S.CER ECJ0EB1E102K	B	50.4/142.5
C315	4030017730	S.CER ECJ0EB1E471K	B	136.5/92.3
C318	4030017460	S.CER ECJ0EB1E102K	T	117.8/106.3
C319	4030017460	S.CER ECJ0EB1E102K	T	117.8/105.4
C320	4030017460	S.CER ECJ0EB1E102K	T	115.2/106.3
C321	4030017420	S.CER ECJ0EC1H470J	T	66/57.5
C322	4030017420	S.CER ECJ0EC1H470J	T	62.3/52.9
C323	4030017350	S.CER ECJ0EC1H020B	B	45.6/138.8
C324	4030017640	S.CER ECJ0EC1H120J	B	135.6/83.3
C325	4030017460	S.CER ECJ0EB1E102K	B	134.7/90.1
C327	4030017640	S.CER ECJ0EC1H150J	B	142.8/85
C328	4030017420	S.CER ECJ0EC1H470J	B	137.8/92.3
C329	4030017640	S.CER ECJ0EC1H150J	B	36/142.3
C330	4030017460	S.CER ECJ0EB1E102K	B	138.9/92.3
C331	4030017460	S.CER ECJ0EB1E102K	B	60.4/142.5
C332	4030017460	S.CER ECJ0EB1E102K	B	56/142.5
C333	4030016930	S.CER ECJ0EB1A104K	T	23.1/29.4
C334	4510009810	S.ELE EEEFK1E220R	T	137.5/89.8
C335	4030017390	S.CER ECJ0EC1H180J	B	144.3/89.3
C336	4030017420	S.CER ECJ0EC1H470J	B	61.3/142.5
C337	4030017400	S.CER ECJ0EC1H220J	B	144.3/88.2
C338	4030017460	S.CER ECJ0EB1E102K	B	36/139.4
C339	4030017460	S.CER ECJ0EB1E102K	B	36/135.4
C340	4030016930	S.CER ECJ0EB1A104K	T	54/20.3
C341	4030017420	S.CER ECJ0EC1H470J	B	132.9/90.1
C342	4030017730	S.CER ECJ0EB1E471K	T	138.8/108
C343	4550002890	S.TAN TEESVA 1A 225M8R	T	148.3/126
C345	4030017460	S.CER ECJ0EB1E102K	B	36/134.8
C346	4030017420	S.CER ECJ0EC1H470J	T	63.2/56.9
C347	4030017460	S.CER ECJ0EB1E102K	T	145/127.7
C348	4030017420	S.CER ECJ0EC1H470J	T	64.2/55.5
C349	4030017400	S.CER ECJ0EC1H220J	B	144.2/91
C350	4030017420	S.CER ECJ0EC1H470J	T	138.7/112.3
C351	4030017460	S.CER ECJ0EB1E102K	T	138.7/113.2
C353	4030017460	S.CER ECJ0EB1E102K	T	140.4/127.7
C354	4030017420	S.CER ECJ0EC1H470J	T	113/117
C355	4030017340	S.CER ECJ0EC1H010B	B	34.4/134
C357	4030017640	S.CER ECJ0EC1H150J	B	36/140.7
C358	4030016790	S.CER ECJ0EB1C103K	T	142.2/127.7
C359	4510009550	S.ELE EEEFK1C100R	T	105.3/87.6
C360	4030017460	S.CER ECJ0EB1E102K	T	113.9/117
C362	4030017580	S.CER ECJ0EC1H060C	B	30.7/141.2
C364	4030011040	S.CER GRM31M4C2H2R0CY21L (GRM42-6 CK) [USA-01]	B	93.3/119.2
	4030011040	S.CER GRM31M4C2H2R0CY21L (GRM42-6 CK) [EXP-01]		
C365	4030017730	S.CER ECJ0EB1E471K	T	114.8/117
C366	4030018900	S.CER ECJ0EB0J474K [USA-01]	T	145/124.4
	4030018900	S.CER ECJ0EB0J474K [EXP-01]		
	4030016930	S.CER ECJ0EB1A104K [EUR-01]		
C367	4510009810	S.ELE EEEFK1E220R	T	110.3/113.1
C368	4030006860	S.CER C1608 JB 1H 102K-T	T	87.7/142
C370	4030011120	S.CER GRM31M2C2H100JV01L (GRM42-6 CH)	B	97.4/123.5
C371				

[MAIN UNIT]

REF NO.	PARTS NO.	DESCRIPTION	M.	H/V LOCATION
C387	4030017390	S.CER ECJ0EC1H180J	B	86/135.9
C388	4510009550	S.ELE EEEFK1C100R	T	123.3/76.8
C389	4030017200	S.CER GRM31M2C2H102KY01L (GHM1030 R)	B	94.2/132.5
C390	4030011170	S.CER GRM31M2C2H180JV01L (GRM42-6 CH)	B	84.7/131.6
C391	4030017460	S.CER ECJ0EB1E102K	T	115.3/74
C392	4030017520	S.CER ECJ0EC1H0R3B	B	86/130
C394	4550006250	S.TAN TEESVA 1A 106M8R	B	26.3/15.3
C396	4510009550	S.ELE EEEFK1C100R	T	97/77.8
C397	4030017460	S.CER ECJ0EB1E102K	T	136.6/122.5
C398	4550006250	S.TAN TEESVA 1A 106M8R	B	31.7/15.5
C399	4030017460	S.CER ECJ0EB1E102K	T	100/76.1
C400	4030017460	S.CER ECJ0EB1E102K	B	85.6/103.9
C401	4030011170	S.CER GRM31M2C2H180JV01L (GRM42-6 CH)	B	103.4/131.2
C402	4030016930	S.CER ECJ0EB1A104K	T	47.2/71.6
C404	4030017460	S.CER ECJ0EB1E102K	T	143.1/127.7
C405	4030017420	S.CER ECJ0EC1H470J	B	57.6/56.9
C406	4030016790	S.CER ECJ0EB1C103K	T	103.5/76.2
C408	4030017460	S.CER ECJ0EB1E102K	B	85.6/127.6
C409	4030011170	S.CER GRM31M2C2H180JV01L (GRM42-6 CH)	B	112.4/131.2
C410	4030011170	S.CER GRM31M2C2H180JV01L (GRM42-6 CH)	B	114.6/131.2
C411	4550007650	S.TAN F931V105MAABMA	T	37.5/68.6
C412	4030017460	S.CER ECJ0EB1E102K	T	104.5/77.8
C413	4030016930	S.CER ECJ0EB1A104K	T	38.5/71.9
C414	4030017420	S.CER ECJ0EC1H470J	B	37.6/134
C415	4550007650	S.TAN F931V105MAABMA	T	37.5/63.4
C416	4550006250	S.TAN TEESVA 1A 106M8R	T	106.9/81.6
C417	4030016930	S.CER ECJ0EB1A104K	T	15/125.7
C418	4550007650	S.TAN F931V105MAABMA	T	39.4/73.9
C419	4030011170	S.CER GRM31M2C2H180JV01L (GRM42-6 CH)	B	117.3/131.2
C420	4030016930	S.CER ECJ0EB1A104K	B	27.4/18.5
C421	4030017460	S.CER ECJ0EB1E102K	B	86.5/127.6
C422	4030017730	S.CER ECJ0EB1E471K	B	119.6/139.5
C423	4030017460	S.CER ECJ0EB1E102K	T	121.5/145.1
C424	4030016930	S.CER ECJ0EB1A104K	T	14.1/125.7
C426	4030017640	S.CER ECJ0EC1H150J	B	120.9/139.5
C428	4030017390	S.CER ECJ0EC1H180J	B	144.3/86.6
C429	4030017460	S.CER ECJ0EB1E102K	B	122.4/143.4
C431	4030018860	S.CER ECJ0EB0J105K	B	33.3/13.6
C432	4030016930	S.CER ECJ0EB1A104K	T	10.8/120.6
C433	4030017730	S.CER ECJ0EB1E471K	B	139.5/138.1
C434	4030017460	S.CER ECJ0EB1E102K	T	57.7/133.5
C435	4030017460	S.CER ECJ0EB1E102K	B	134.8/29.8
C436	4030011170	S.CER GRM31M2C2H180JV01L (GRM42-6 CH)	B	143.7/137
C437	4030016930	S.CER ECJ0EB1A104K	B	34.4/12
C438	4030016790	S.CER ECJ0EB1C103K	T	109.7/89
C439	4510009810	S.ELE EEEFK1E220R	T	129.9/96.8
C440	4030018900	S.CER ECJ0EB0J474K	T	7.9/129.6
C441	4030017440	S.CER ECJ0EC1H221J	T	12/126.2
C442	4510009680	S.ELE EEEFK1E471P	B	9.6/119.8
C443	4030017460	S.CER ECJ0EB1E102K	T	108.8/89
C444	4030011170	S.CER GRM31M2C2H180JV01L (GRM42-6 CH)	B	147/148.9
C445	4030017600	S.CER ECJ0EC1H080C	B	26.1/141
C446	4030017460	S.CER ECJ0EB1E102K	T	6.6/130.1
C448	4030017460	S.CER ECJ0EB1E102K	T	126.9/103.4
C449	4510008870	S.ELE EEE1AA471UP	B	8.9/139.2
C450	4030016930	S.CER ECJ0EB1A104K	T	7.5/125.1
C451	4030018860	S.CER ECJ0EB0J105K	T	9.7/125.5
C452	4030018860	S.CER ECJ0EB0J105K	T	71.5/98.2
C453	4030017460	S.CER ECJ0EB1E102K	T	127.9/103.4
C454	4030017430	S.CER ECJ0EC1H101J	B	46.3/56.9
C458	4030017460	S.CER ECJ0EB1E102K	T	129.6/113.3
C459	4030017460	S.CER ECJ0EB1E102K	T	117.8/117.7
C460	4030017460	S.CER ECJ0EB1E102K	B	9.6/147.3
C461	4030017420	S.CER ECJ0EC1H470J	T	130.5/113.3
C462	4030017420	S.CER ECJ0EC1H470J	T	117.8/116.7
C463	4030017420	S.CER ECJ0EC1H470J	B	9.6/146.4
C464	4510009680	S.ELE EEEFK1E471P	B	144.4/121.1
C465	4550006250	S.TAN TEESVA 1A 106M8R	T	96.1/87.8
C466	4030017420	S.CER ECJ0EC1H470J	T	99.9/88
C467	4030016930	S.CER ECJ0EB1A104K	T	62.3/58.5
C468	4030016930	S.CER ECJ0EB1A104K	T	61.7/56.9
C469	4030017460	S.CER ECJ0EB1E102K	B	141.3/90.1
C470	4030018860	S.CER ECJ0EB0J105K	T	7.4/122.3
C471	4030016790	S.CER ECJ0EB1C103K	T	6.2/123.6
C472	4030018860	S.CER ECJ0EB0J105K	T	10.9/117.7
C473	4030018860	S.CER ECJ0EB0J105K	T	5/118.9
C474	4030017780	S.CER ECJ0EB1E472K	T	115.3/17.6
C475	4510008120	S.ELE 16 CE 100 BS	T	125.1/12.1
C476	4510008120	S.ELE 16 CE 100 BS	T	125.1/19.3
C477	4030017780	S.CER ECJ0EB1E472K	T	118.9/12.2
C478	4030017780	S.CER ECJ0EB1E472K	T	115.3/12.2
C479	4510008120	S.ELE 16 CE 100 BS	T	104.8/14.3
C481	4030017460	S.CER ECJ0EB1E102K	B	63.2/122.2
C491	4030016930	S.CER ECJ0EB1A104K	B	60.4/60.1
C492	4030016930	S.CER ECJ0EB1A104K	B	13.5/32.6
C493	4510008870	S.ELE EEE1AA471UP	B	66.3/45.3
C494	4030016930	S.CER ECJ0EB1A104K	T	101.5/92.4
C495	4030016930	S.CER ECJ0EB1A104K	T	101.5/90.1
C496	4030016930	S.CER ECJ0EB1A104K	T	123.3/92.9
C497	4030016930	S.CER ECJ0EB1A104K	T	109.9/81.2
C498	4030016930	S.CER ECJ0EB1A104K	T	11.4/43.2
C501	4030017420	S.CER ECJ0EC1H470J	T	11.7/31.2
C502	4030017460	S.CER ECJ0EB1E102K	T	29.5/2.8
C503	4030017420	S.CER ECJ0EC1H470J	T	48/99.4
C506	4030016930	S.CER ECJ0EB1A104K	B	26.3/43.3
C507	4030016930	S.CER ECJ0EB1A104K	B	32.9/31
C508	4030016930	S.CER ECJ0EB1A104K	B	40.1/42.7

[MAIN UNIT]

REF NO.	PARTS NO.	DESCRIPTION	M.	H/V LOCATION
C509	4030016930	S.CER ECJ0EB1A104K	B	26.2/39
C510	4030016930	S.CER ECJ0EB1A104K	B	26.6/30
C511	4030016930	S.CER ECJ0EB1A104K	B	40.1/34.2
C512	4030017420	S.CER ECJ0EC1H470J	T	92/14.7
C513	4550006250	S.TAN TEESVA 1A 106M8R	B	8.4/59.8
C514	4030016930	S.CER ECJ0EB1A104K	B	11.7/53.5
C515	4030016930	S.CER ECJ0EB1A104K	B	15.5/54.4
C516	4030016930	S.CER ECJ0EB1A104K	T	65.1/69.6
C517	4030016930	S.CER ECJ0EB1A104K	B	15.6/63.1
C518	4030016930	S.CER ECJ0EB1A104K	B	12.4/62.4
C519	4030017460	S.CER ECJ0EB1E102K	B	15.6/59.9
C521	4030016930	S.CER ECJ0EB1A104K	B	18.1/53.6
C522	4030016930	S.CER ECJ0EB1A104K	T	51.2/31.8
C523	4030016930	S.CER ECJ0EB1A104K	T	51.2/31
C524	4030018910	S.CER C1608 JB 0J 475K-T	T	9.5/56
C525	4030018910	S.CER C1608 JB 0J 475K-T	B	25.8/58.3
C526	4030017730	S.CER ECJ0EB1E471K	B	29.8/57.9
C527	4030016790	S.CER ECJ0EB1C103K	B	26.1/50.3
C528	4030017670	S.CER ECJ0EC1H390J	B	37.6/120.7
C529	4030017630	S.CER ECJ0EC1H120J	B	39/112.2
C530	4030017420	S.CER ECJ0EC1H470J	T	58.7/62.6
C531	4030017670	S.CER ECJ0EC1H390J	B	93/61.9
C532	4030017670	S.CER ECJ0EC1H390J	B	94.5/52
C533	4510008120	S.ELE 16 CE 100 BS	T	125.1/26.4
C534	4030016790	S.CER ECJ0EB1C103K	T	118.4/26.7
C535	4030016790	S.CER ECJ0EB1C103K	B	66.4/102.5
C536	4030016790	S.CER ECJ0EB1C103K	B	64.8/99.1
C538	4030006860	S.CER C1608 JB 1H 102K-T	T	36.2/145.1
C539	4030017790	S.CER ECJ0EB1E682K	T	22.8/57
C540	4030017730	S.CER ECJ0EB1E471K	T	21.2/56.6
C541	4030016930	S.CER ECJ0EB1A104K	T	22.8/55.4
C542	4030017440	S.CER ECJ0EC1H221J	T	27.1/55
C543	4030016930	S.CER ECJ0EB1A104K	T	56.3/68.9
C544	4030017460	S.CER ECJ0EB1E102K	T	62.4/72.9
C545	4030011120	S.CER GRM31M2C2H100JV01L (GRM42-6 CH) [USA-01]	T	97.6/106.8
	4030011120	S.CER GRM31M2C2H01JV01L (GRM42-6 CH) [EXP-01]		
	4030011100	S.CER GRM31M2C2H8R0DV01L (GRM42-6 CH) [EUR-01]		
C546	4030018910	S.CER C1608 JB 0J 475K-T	B	40.4/56.7
C547	4030017760	S.CER ECJ0EB1H222K	T	53.7/72.1
C548	4030016930	S.CER ECJ0EB1A104K	T	14.1/120.6
C549	4030017420	S.CER ECJ0EC1H470J	T	22/85.7
C550	4030017420	S.CER ECJ0EC1H470J	T	71.5/85.1
C551	4030017330	S.CER ECJ0EF1C104Z	T	114.1/28.1
C552	4030016790	S.CER ECJ0EB1C103K	B	121.9/48.8
C553	4030016930	S.CER ECJ0EB1A104K	B	30.8/19.4
C555	4030016930	S.CER ECJ0EB1A104K	B	69.8/75.5
C556	4030016930	S.CER ECJ0EB1A104K	T	105.2/28.6
C557	4030016930	S.CER ECJ0EB1A104K	T	97/28.6
C558	4550006250	S.TAN TEESVA 1A 106M8R	T	95.1/27.9
C559	4550007080	S.TAN TEESVA 1C 106M8R	T	45.9/75.5
C562	4030017420	S.CER ECJ0EC1H470J	T	34.7/79.6
C563	4030016930	S.CER ECJ0EB1A104K	B	25.6/122
C566	4030018860	S.CER ECJ0EB0J105K	B	39/72.7
C570	4030017460	S.CER ECJ0EB1E102K	B	70.7/136.1
C571	4030017580	S.CER ECJ0EC1H060C	T	64/99.1
C572	4030017580	S.CER ECJ0EC1H060C	T	64.9/99.1
C573	4030017580	S.CER ECJ0EC1H060C	T	64.7/97.8
C574	4030017580	S.CER ECJ0EC1H060C	B	61.4/134.9
C575	4030017420	S.CER ECJ0EC1H470J	B	61.4/132
C576	4030017460	S.CER ECJ0EB1E102K	T	67.3/105.8
C577	4030017460	S.CER ECJ0EB1E102K	T	67.3/104.9
C578	4030017200	S.CER GRM31BR32J102KY01L (GHM1030 R)	T	90.8/126
C579	4550006250	S.TAN TEESVA 1A 106M8R	B	98.3/46.9
C580	4030017420	S.CER ECJ0EC1H470J	T	100.7/73.5
C581	4030018910	S.CER C1608 JB 0J 475K-T	B	46.3/60.9
C582	4030018910	S.CER C1608 JB 0J 475K-T	B	65.2/61.3
C583	4030016930	S.CER ECJ0EB1A104K	B	46.3/58.6
C584	4030016790	S.CER ECJ0EB1C103K	B	56.7/55.3
C585	4030016930	S.CER ECJ0EB1A104K	B	54.9/58.6
C586	4030017730	S.CER ECJ0EB1E471K	B	54.9/56.9
C587	4030016790	S.CER ECJ0EB1C103K	B	52.3/59.8
C588	4030018910	S.CER C1608 JB 0J 475K-T	B	65.2/62.5
C589	4030017360	S.CER ECJ0EC1H030B	B	103.2/51.6
C590	4030017570	S.CER ECJ0EC1H040B	B	102.4/43.5
C601	4030011100	S.CER GRM31M2C2H8R0DV01L (GRM42-6 CH) [USA-01]	T	97.6/111.3
	4030011100	S.CER GRM31M2C2H8R0DV01L (GRM42-6 CH) [EXP-01]		
C610	4030018080	S.CER ECJ0EB1H182K	T	63.3/69.6
C612	4030017460	S.CER ECJ0EB1E102K	B	55.7/29.9
C614	4030017730	S.CER ECJ0EB1E471K	B	29/13.2
C616	4030017460	S.CER ECJ0EB1E102K	T	95.3/62.2
C617	4030017420	S.CER ECJ0EC1H470J	T	59.8/65
C618	4030017420	S.CER ECJ0EC1H470J	T	64.2/53.8
C619	4030017420	S.CER ECJ0EC1H470J	T	76.8/109.5
C620	4030017420	S.CER ECJ0EC1H470J	T	73.8/97.8
C621	4030017420	S.CER ECJ0EC1H470J	T	31.5/2.8
C622	4030018910	S.CER C1608 JB 0J 475K-T	T	64.3/73.2
C623	4030017330	S.CER ECJ0EF1C104Z	B	126.8/16
C624	4030017330	S.CER ECJ0EF1C104Z	B	

[MAIN UNIT]

REF NO.	PARTS NO.	DESCRIPTION	M.	H/V LOCATION
J2	6510023092	S.CON 20FLT-SM2-TB(LF)(SN)(M)	T	14.8/15.6
J4	6510023511	S.CON 28FLT-SM2-TB(LF)(SN)	T	70.8/102
J5	6510023110	CON 3008L-8P8C <KIN>		
J6	6450000140	CON HSJ0807-01-010		
J8	6510023092	S.CON 20FLT-SM2-TB(LF)(SN)(M)	T	59.1/15.6
J9	6510019371	S.CON B3B-ZR-SM4-TF(LF)(SN)	T	94.6/14.3
J10	6510004910	CON NR-DS-E 01 <NIP>		
J11	6510004910	CON NR-DS-E 01 <NIP>		
DS1	5040002961	S.LED SML-A12MT T86J	B	96/1.1
DS2	5040002961	S.LED SML-A12MT T86J	B	126/1.1
DS3	5040003000	S.LED SML-A12UT-T86	B	111/1.1
MF1	2710000870	FAN AFB0512HB-7X22 <USE>HK		
W1	7030012290	JUM RDS2T0R0		
W2	7030012290	JUM RDS2T0R0		
W4	8900017520	CAB OPC-1783		
EP1	6910015370	S.BEA ACZ1005Y-102-T	B	129.1/48.4
EP2	6910015370	S.BEA ACZ1005Y-102-T	B	115.5/45.6
EP3	6910015370	S.BEA ACZ1005Y-102-T	B	32.4/81.6
EP4	6910016330	S.BEA MMZ1005S 601CT-S	B	30.4/60.5
EP5	6910015370	S.BEA ACZ1005Y-102-T	B	39/74.3
EP6	6910015370	S.BEA ACZ1005Y-102-T	T	38.5/108.3
EP7	6910016330	S.BEA MMZ1005S 601CT-S	B	40.7/36.7
EP8	6910015370	S.BEA ACZ1005Y-102-T	B	95.4/49
EP9	6910016330	S.BEA MMZ1005S 601CT-S	T	48.8/39.3
EP10	6910011560	BEA HF70BB4.5X5X1.6		
EP13	6910011330	TER OT-009 M3		
EP14	6910011330	TER OT-009 M3		
EP16	6910018460	S.BEA MMZ1005Y102C-T	T	64.1/105
EP17	6910018460	S.BEA MMZ1005Y102C-T	T	65.1/105
EP18	6910018460	S.BEA MMZ1005Y102C-T	T	66.1/105
EP19	6910018460	S.BEA MMZ1005Y102C-T	T	66.1/106.8
EP20	6910018460	S.BEA MMZ1005Y102C-T	T	62.8/98.7
EP21	6910018460	S.BEA MMZ1005Y102C-T	T	62.8/99.6
EP22	6910018460	S.BEA MMZ1005Y102C-T	T	74.1/105
EP23	6910018460	S.BEA MMZ1005Y102C-T	T	73.2/105
EP24	6910018460	S.BEA MMZ1005Y102C-T	T	72.3/105
EP25	6910018460	S.BEA MMZ1005Y102C-T	T	71.1/105
EP26	6910018460	S.BEA MMZ1005Y102C-T	T	72.4/99
EP27	6910018460	S.BEA MMZ1005Y102C-T	T	68.2/99.1
EP28	6910018460	S.BEA MMZ1005Y102C-T	T	67.3/99.1
EP29	6910018460	S.BEA MMZ1005Y102C-T	T	65.8/99.1
EP30	6910018460	S.BEA MMZ1005Y102C-T	T	74.3/99
EP31	6910018460	S.BEA MMZ1005Y102C-T	T	70.6/98.2

[CONNECT UNIT]

REF NO.	PARTS NO.	DESCRIPTION	M.	H/V LOCATION
C601	4030017420	S.CER ECJ0EC1H470J	T	13.8/12.4
C602	4030017400	S.CER ECJ0EC1H220J	T	12.2/12.4
C603	4030017420	S.CER ECJ0EC1H470J	T	16.5/12.4
C604	4030017400	S.CER ECJ0EC1H220J	T	15/14.2
C605	4030017420	S.CER ECJ0EC1H470J	T	17.8/13.9
C606	4030017420	S.CER ECJ0EC1H470J	T	19.4/12.4
C607	4030017420	S.CER ECJ0EC1H470J	T	20.5/13.9
C608	4030017420	S.CER ECJ0EC1H470J	T	22.6/12.4
C609	4030017420	S.CER ECJ0EC1H470J	T	25.5/12.4
C610	4030017420	S.CER ECJ0EC1H470J	T	29.7/12.8
C611	4030017420	S.CER ECJ0EC1H470J	T	31/14.1
C612	4030017420	S.CER ECJ0EC1H470J	T	32.4/12.8
C613	4030017420	S.CER ECJ0EC1H470J	T	33.5/14.1
C614	4030017420	S.CER ECJ0EC1H470J	T	35.2/14.1
C615	4030017420	S.CER ECJ0EC1H470J	T	35.7/12.8
C616	4030017420	S.CER ECJ0EC1H470J	B	35.2/15.6
C617	4030017420	S.CER ECJ0EC1H470J	T	37.5/13.5
C618	4030017420	S.CER ECJ0EC1H470J	T	39.3/12.2
C619	4030017420	S.CER ECJ0EC1H470J	T	39.9/13.4
C620	4030017420	S.CER ECJ0EC1H470J	T	41.3/12.6
C621	4030017420	S.CER ECJ0EC1H470J	T	27.4/13.9
J601	6510026290	S.CON IMSA-9631S-28Y921	B	22.8/16.2
J602	6510023210	CON CD6125SA1J0 <CVI>		
S1	2260003070	S.SWI MINISMDC150F/24-2	B	38.9/18
W601	8900017500	CAB OPC-1852 (P0.5,N28,L90) <TJM>		

M.=Mounted side (T: Mounted on the Top side, B: Mounted on the Bottom side)
S.=Surface mount

BOARD LAYOUTS

• MAIN UNIT
(TOP VIEW)

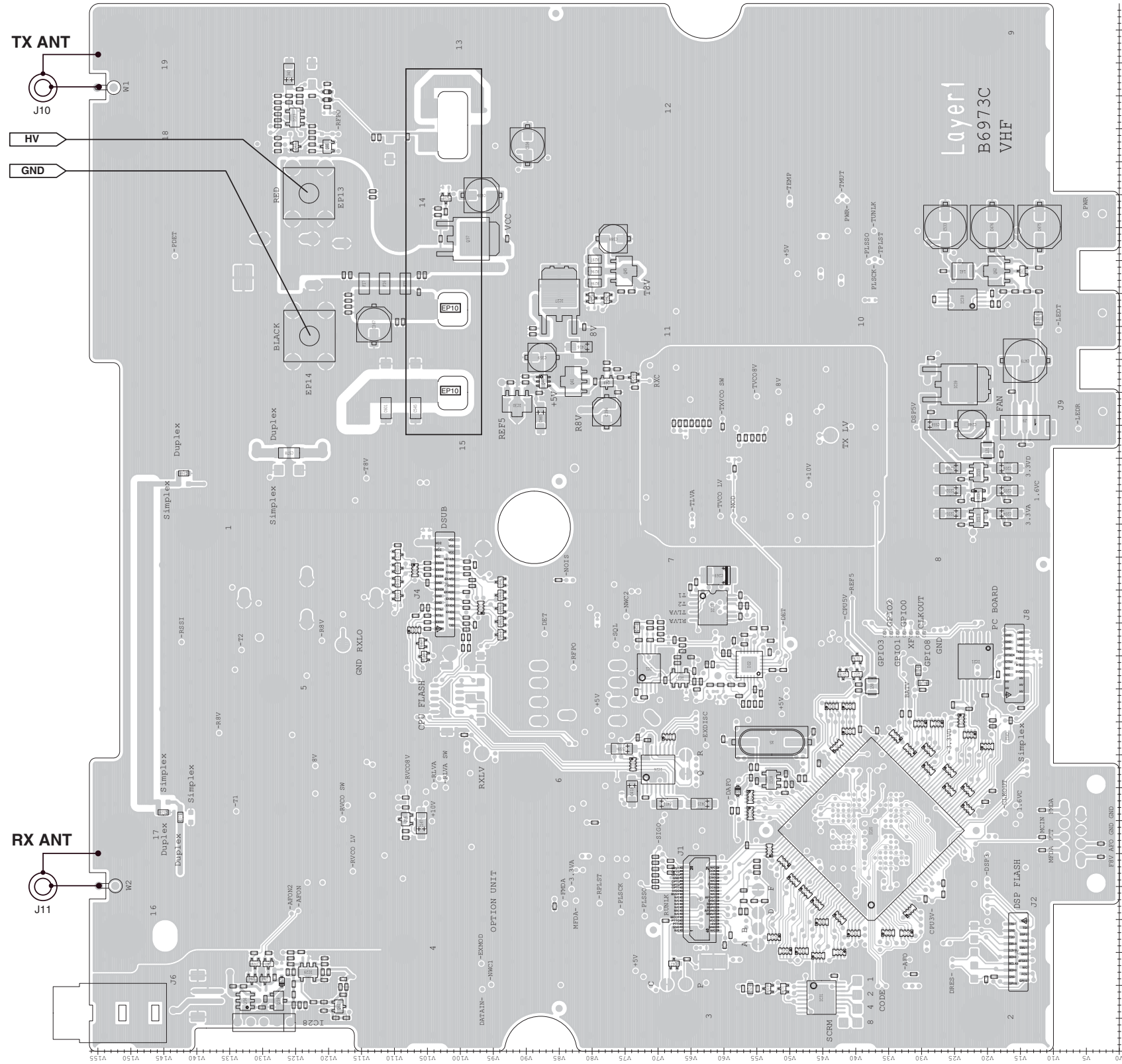

The combination of this side and the bottom side shows the board layout in the same configuration as the actual P.C.Board.

• MAIN UNIT
(BOTTOM VIEW)

The combination of this side and the bottom side shows the board layout in the same configuration as the actual P.C.Board.

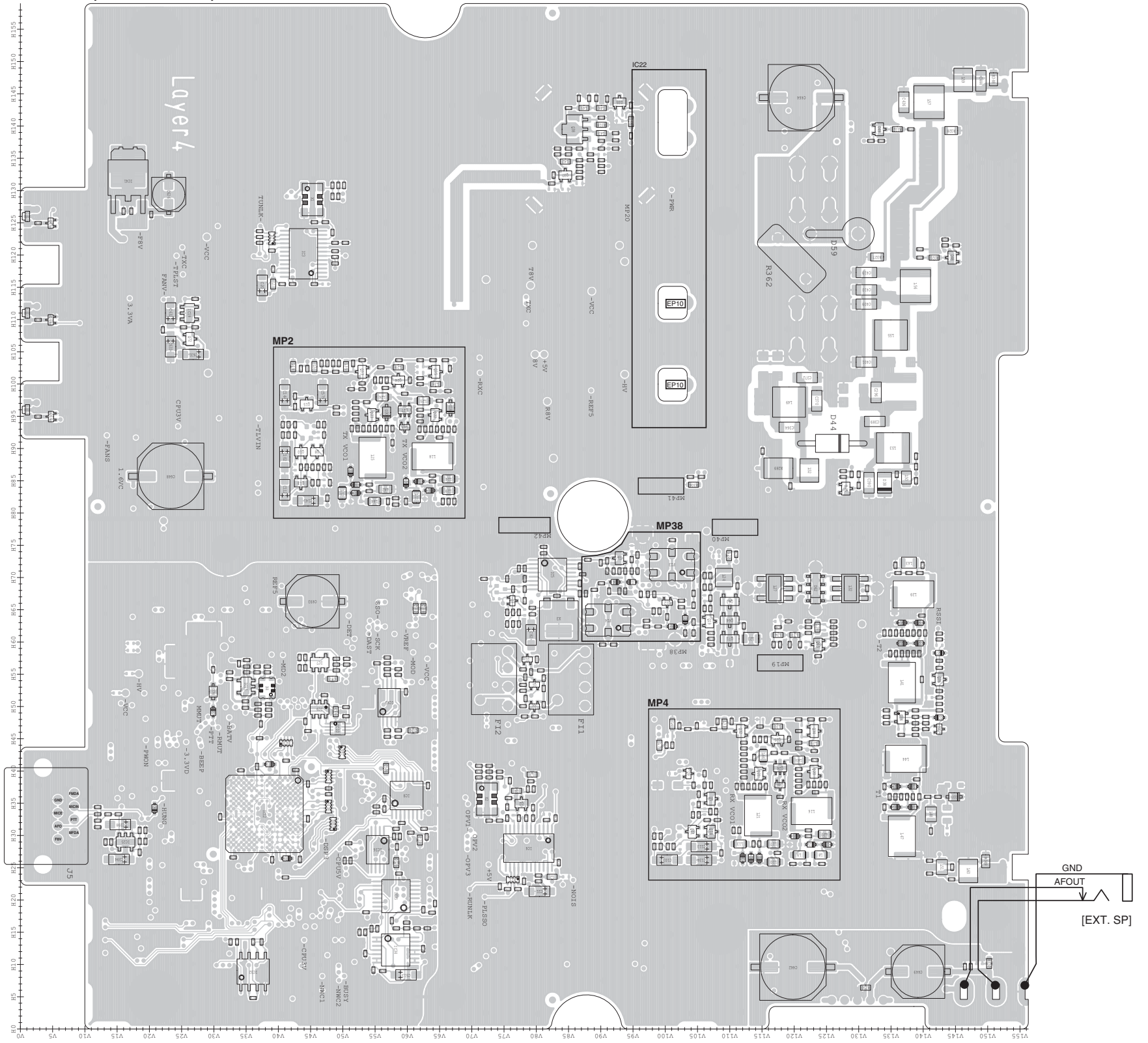

MAIN UNIT (2/3)

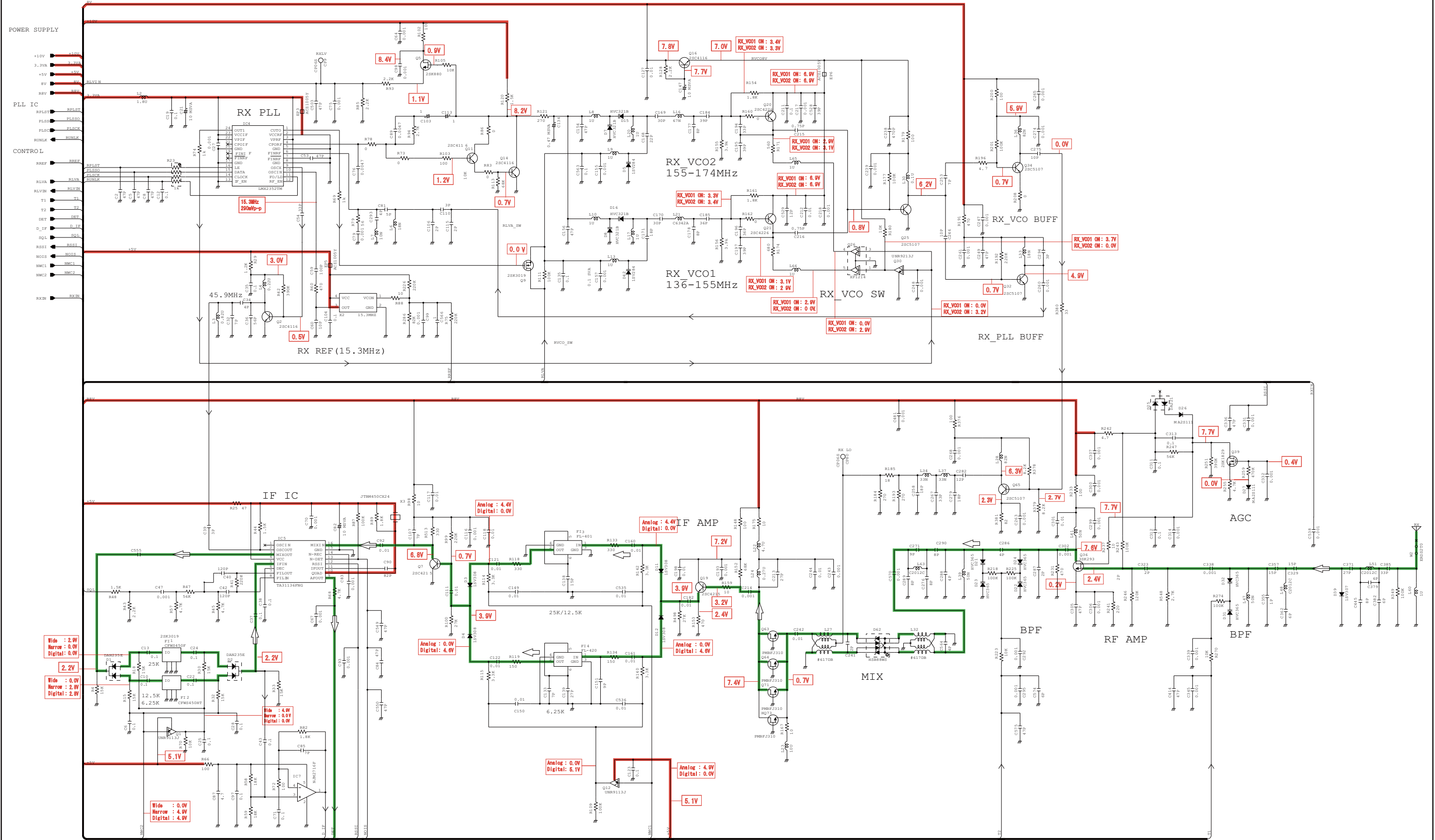

*; Refer to "PARTS LIST"

MAIN UNIT (3/3)

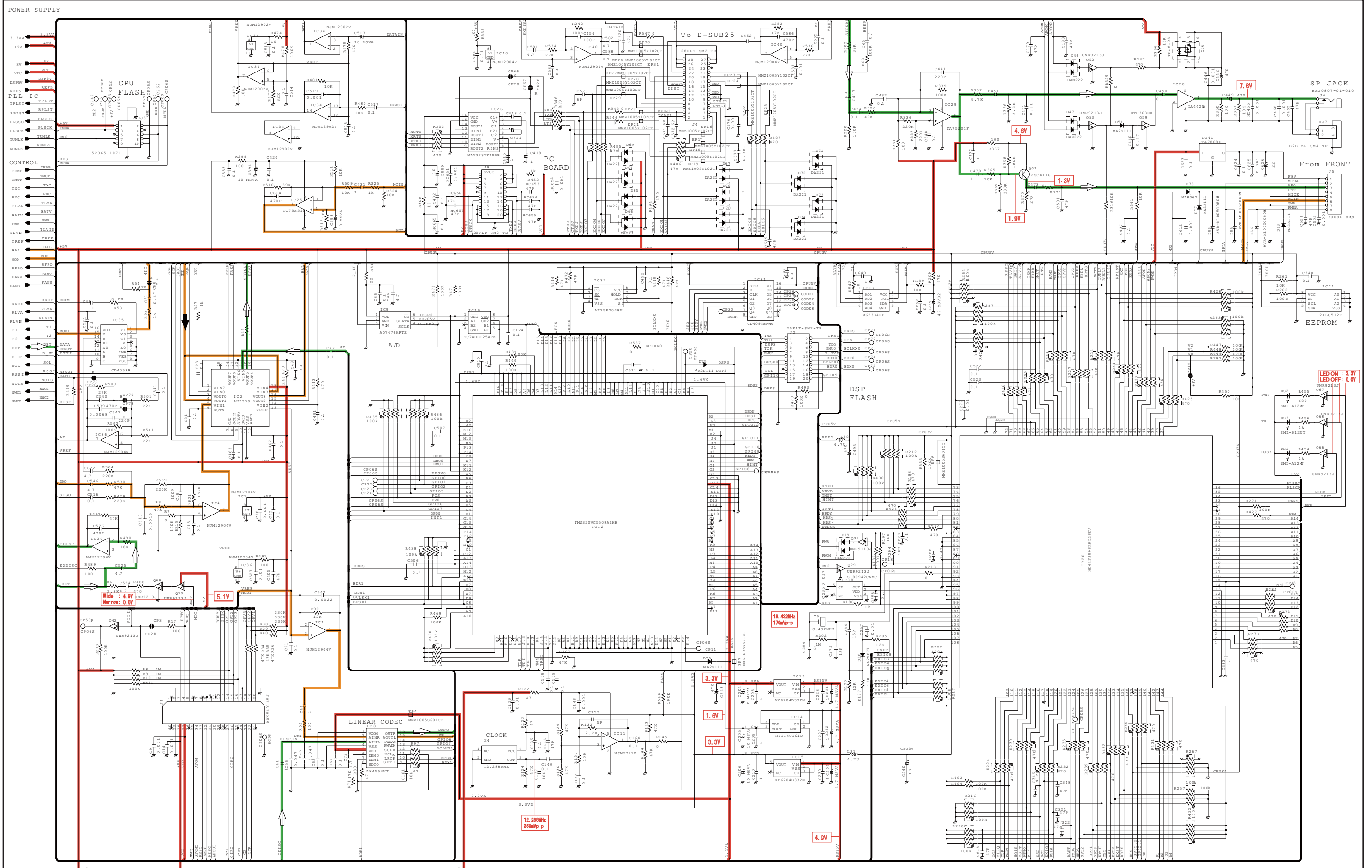

*; Refer to "PARTS LIST"



SERVICE MANUAL

CHANNEL EXTENSION MODULE
UR-FR5000
UR-FR5100

S-14515XZ-C1
Aug. 2008

INTRODUCTION

This service manual describes the latest service information for the **UR-FR5000 UR-FR5100 CHANNEL EXTENSION MODULE** at the time of publication.

MODEL	VERSION	CH. SPACING (kHz)	TX POWER	FREQUENCY RANGE
UR-FR5000	USA-01	7.5/15/30	50 W	136–174 MHz
	EXP-01	12.5/25.0		
UR-FR5100	EUR-01	12.5/20.0/25.0	25 W	

UNIT ABBREVIATIONS:

M=MAIN UNIT
CN=CONNECT UNIT

CAUTION

NEVER connect the repeater to an AC outlet or to a DC power supply that uses more than specified. This will ruin the repeater.

DO NOT expose the repeater to rain, snow or any liquids.

DO NOT reverse the polarities of the power supply when connecting the repeater.

DO NOT apply an RF signal of more than 20 dBm (100 mW) to the antenna connector. This could damage the repeater's front-end.

To upgrade quality, any electrical or mechanical parts and internal circuits are subject to change without notice or obligation.



ORDERING PARTS

Be sure to include the following four points when ordering replacement parts:

1. 10-digit Icom parts numbers
2. Component name
3. Equipment model name and unit name
4. Quantity required

<ORDER EXAMPLE>

1110003491 S.IC TA31136FNG UR-FR5000 MAIN UNIT 5 pieces
8820001210 Screw 2438 screw UR-FR5000 Top cover 10 pieces

Addresses are provided on the inside back cover for your convenience.

REPAIR NOTES

1. Make sure the problem is internal before disassembling the repeater.
2. **DO NOT** open the repeater until the repeater is disconnected from its power source.
3. **DO NOT** force any of the variable components. Turn them slowly and smoothly.
4. **DO NOT** short any circuits or electronic parts. An insulated tuning tool **MUST** be used for all adjustments.
5. **DO NOT** keep power ON for a long time when the repeater is defective.
6. **DO NOT** transmit power into a Standard Signal Generator or a Sweep Generator.
7. **ALWAYS** connect a 50 dB to 60 dB attenuator between the repeater and a Deviation Meter or Spectrum Analyzer when using such test equipment.
8. **READ** the instructions of test equipment thoroughly before connecting a test equipment to the repeater.

CONTENTS

SECTION 1 SPECIFICATIONS

SECTION 2 INSIDE VIEWS

SECTION 3 DISASSEMBLY INSTRUCTION

SECTION 4 OPTIONAL UNIT INSTALLATION

SECTION 5 CIRCUIT DESCRIPITON

5-1	RECEIVER CIRCUITS	5-1
5-2	TRANSMITTER CIRCUITS	5-1
5-3	FREQUENCY SYNTHESIZER CIRCUITS	5-2
5-4	OTHER CIRCUITS	5-2
5-5	CPU (M: IC20) PORT ALLOCATION	5-3

SECTION 6 ADJUSTMENT PROCEDURES

6-1	PREPARATION	6-1
6-2	FREQUENCY ADJUSTMENT	6-6
6-3	TRANSMIT ADJUSTMENT	6-7
6-4	RECEIVE ADJUSTMENT	6-8

SECTION 7 PARTS LIST

SECTION 8 MECHANICAL PARTS

SECTION 9 BOARD LAYOUTS

SECTION 10 BLOCK DIAGRAM

SECTION 11 VOLTAGE DIAGRAM

MAIN UNIT (1/3)	11-1
MAIN UNIT (2/3)	11-2
MAIN UNIT (3/3)	11-3
CONNECT UNIT	11-4

SECTION 1

SPECIFICATIONS

■ GENERAL		[UR-FR5000]	[UR-FR5100]
• Frequency coverage		136–174 MHz	
• Conventional channels		max. 32 ch	
• Type of emission	Wide	16K0F3E	
	Middle	–	14K0F3E
	Narrow	11K0F3E/11K0F7E/11K0F7D/11K0F7W/ 8K50F3E ([EXP-01] only)	8K50F3E
	Digital	4K00F1E/4K00F1D/4K00F3E	
• Antenna impedance		50 Ω (Nominal)	
• Operating temperature range		–22°F to +140°F (–30°C to +60°C)	–25°C to +55°C
• Power supply requirement (nominal)		13.6 V DC (Negative ground)	13.2 V DC (Negative ground)
• Current drain (Approx.)	Receiving	500 mA (stand-by), 1900 mA (max. audio)	
	Transmitting	15 A (at 50 W)	8.0 A (at 25 W)
• Dimensions (Projections not included)		6 15/16 (W)×2 3/8 (H)×7 21/32 (D) in.	176 (W)×60 (H)×194 (D) mm
• Weight (Approx.)		4 27/32 lb	2.2 kg

■ TRANSMITTER		[UR-FR5000]	[UR-FR5100]
• Output power		50 W	25 W
• Modulation		Variable reactance frequency modulation	
• Max. frequency deviation	Wide	±5.0 kHz	
	Middle	–	±4.0 kHz
	Narrow	±2.5 kHz	
• Frequency stability		±0.5 ppm	±0.2 kHz
• Spurious emissions		80 dB typ.	0.25 μW (≤1 GHz), 1.00 μW (>1 GHz)
• Adjacent channel power	Wide	76 dB typ.	
	Middle	–	76 dB typ.
	Narrow	69 dB typ.	
	Digital	65 dB typ.	
• Audio harmonic distortion		1% typ. (at AF 1 kHz 40% deviation)	
• Intermodulation attenuation		–	40 dB min.
• Audio frequency response		+2 dB to –8 dB of 6 dB/oct. Wide/Middle from 300 Hz to 3000 Hz Narrow from 300 Hz to 2550 Hz	
• FM Hum and noise (300 Hz–3000 Hz, 750 μs)	Wide	52 dB typ.	
	Narrow	49 dB typ.	
• Audio input impedance (Microphone)		600 Ω	

■ RECEIVER		[UR-FR5000]	[UR-FR5100]
• Receive system		Double-conversion superheterodyne system	
• Intermediate frequencies		1st IF: 46.35 MHz, 2nd IF: 450 kHz	
• Sensitivity	Wide/Narrow	0.3 μ V typ. at 12 dB SINAD	-10 dB μ V max. at 12 dB SINAD
	Wide/Middle/Narrow	–	-10 dB μ V max. at 12 dB SINAD
	Digital	0.25 μ V typ. at 5% BER	0 dB μ V emf max. at 1% BER (PN9)
• Squelch sensitivity (at threshold)		0.25 μ V typ.	
• Adjacent channel selectivity	Wide	80 dB typ. (TIA-603-B) 85 dB typ. (TIA-603)	86 dB typ.
	Middle	–	83 dB typ.
	Narrow	56 dB typ. (TIA-603-B) 77 dB typ. (TIA-603)	77 dB typ.
	Digital	66 dB typ. (EN 301 166, 400 Hz @1%) 63 dB typ. (EN 301 166, PN15 @5%)	67 dB typ.
• Spurious response	Analog	90 dB	80 dB typ.
	Digital	90 dB μ V emf	90 dB μ V emf typ.
• Intermodulation	Wide	78 dB typ.	72 dB typ.
	Middle	–	72 dB typ.
	Narrow	78 dB typ.	71 dB typ.
	Digital	75 dB μ V emf typ.	76 dB μ V emf typ.
• Hum and noise	Wide	52 dB typ.	–
	Middle	–	–
	Narrow	50 dB typ.	–
	Digital	66 dB typ.	–
• Audio output power (at 5% distortion with a 4 Ω load)		4.0 W typ.	3.5 W min.
• Audio output impedance		4 Ω	

Specifications are measured in accordance with TIA-603-B (for Wide and Narrow) or EN 300 166 (Digital) for UR-FR5000.

Specifications are measured in accordance with EN 300 086 (for Wide, Middle and Narrow) or EN 301 166 (Digital) for UR-FR5100.

All stated specifications are subject to change without notice or obligation.

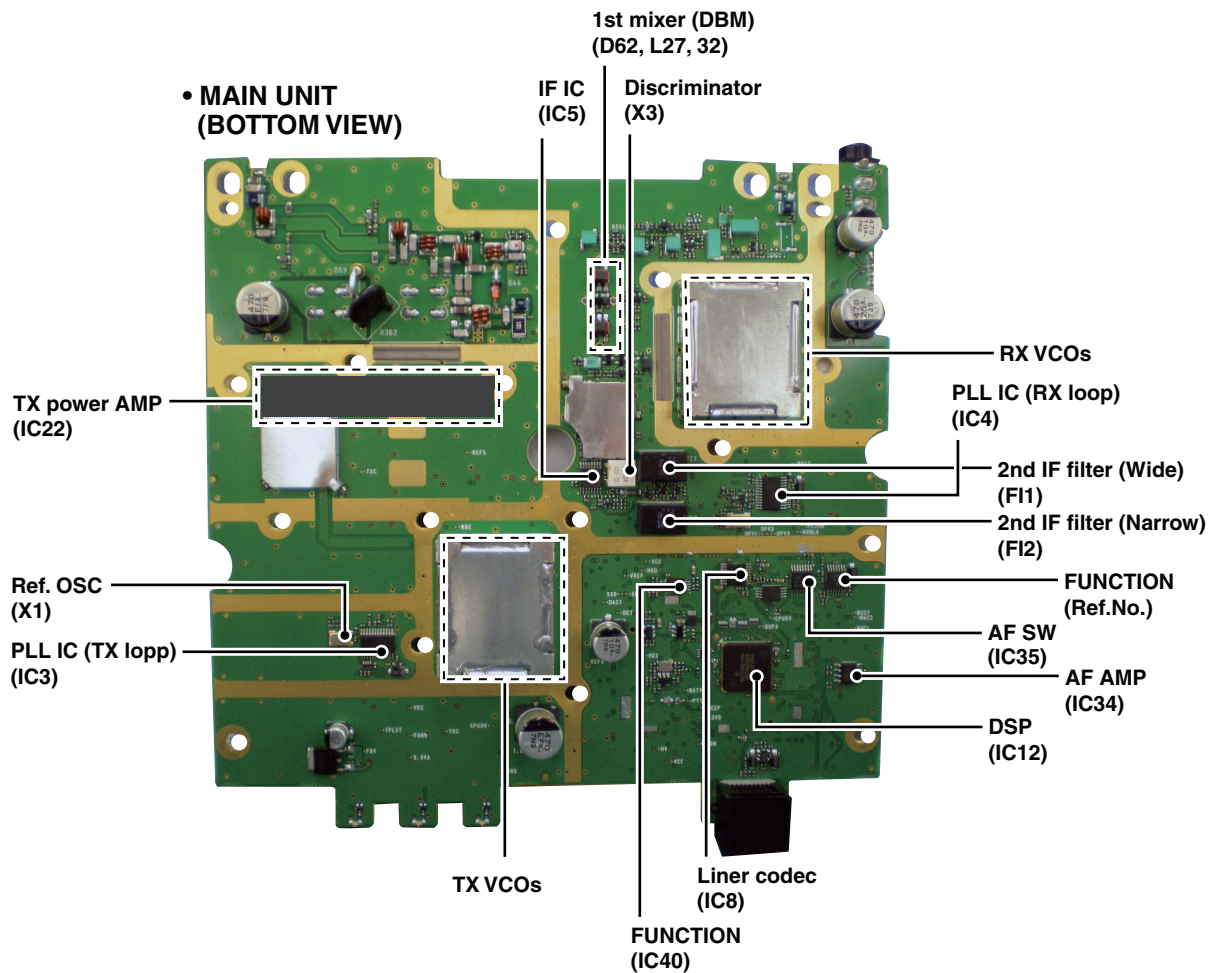
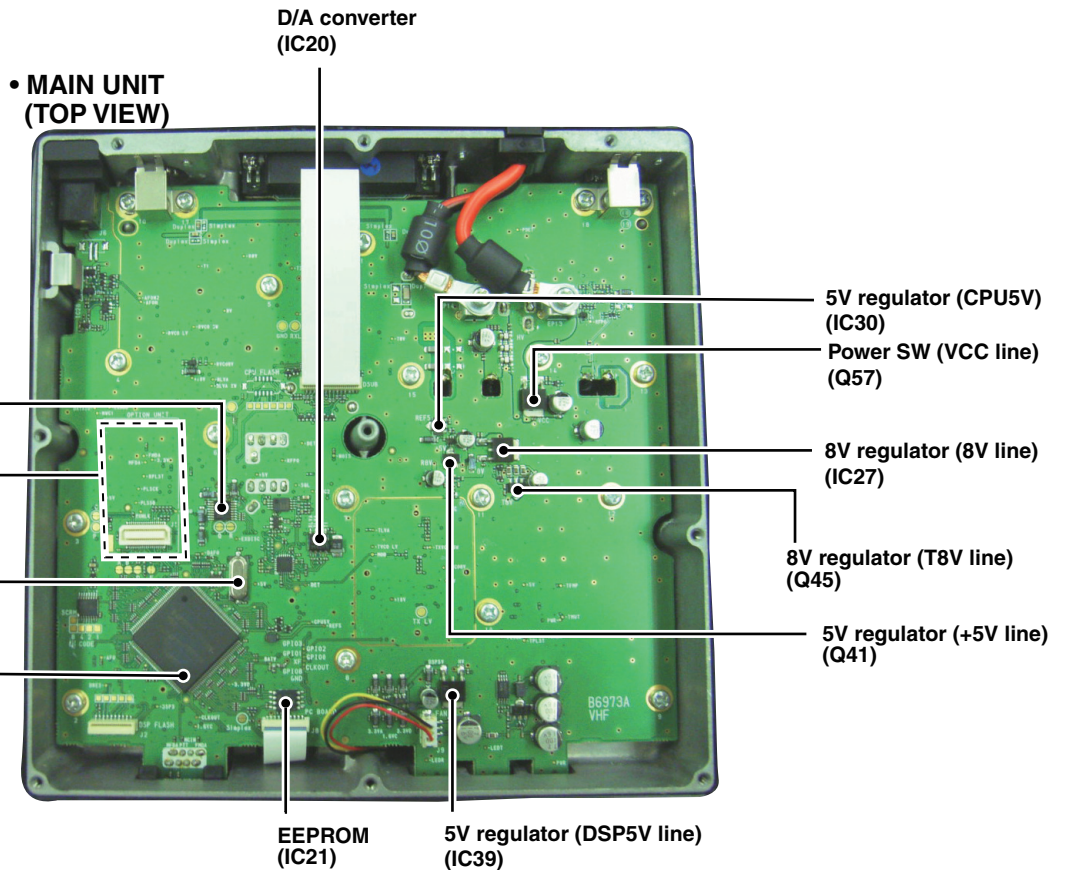

SECTION 3 DISASSEMBLY INSTRUCTION

• Removing the MAIN UNIT

① Unscrew 9 screws, and remove the cover.

(If you are going to install an optional unit, see page 4-1 for the installation.)

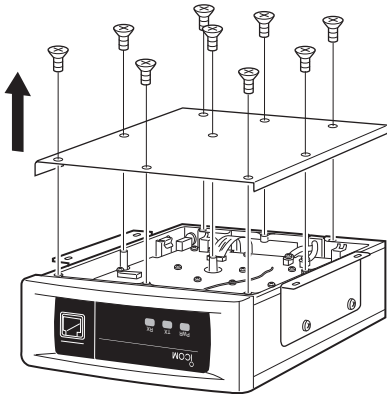

- ② Unsolder 2 points at the ANT cases.
- ③ Unscrew 4 screws from the ANT cases, and remove them.
- ④ Disconnect the flat cable from J4 and the speaker cable from J9.

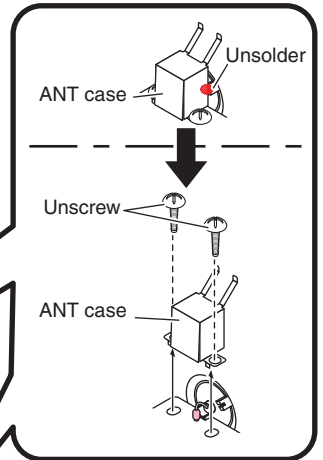

- ⑤ Unsolder 2 points at the bottom of ANT connectors.
- ⑥ Unsolder 4 points at the PA module leads.
- ⑦ Unscrew 2 screws from W4.

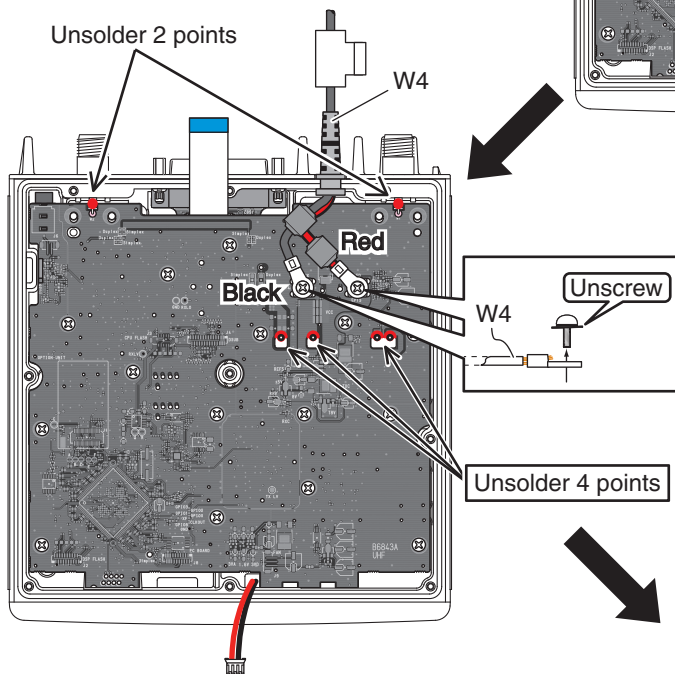
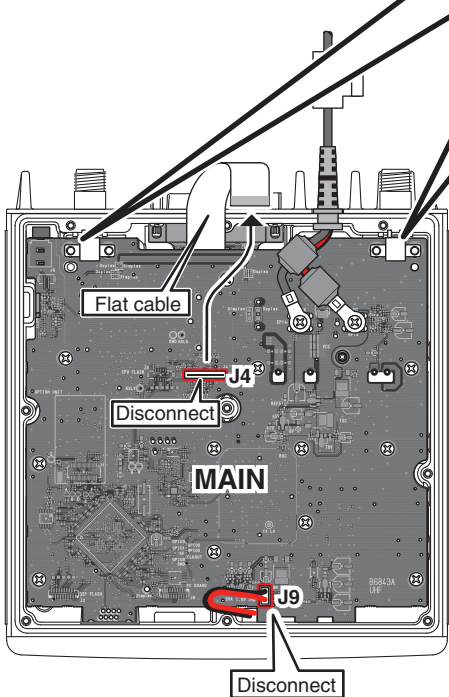

- ⑧ Remove the clip from the side of chassis.
- ⑨ Unscrew 15 screws from the MAIN UNIT, then take off the MAIN UNIT PCB from the chassis.

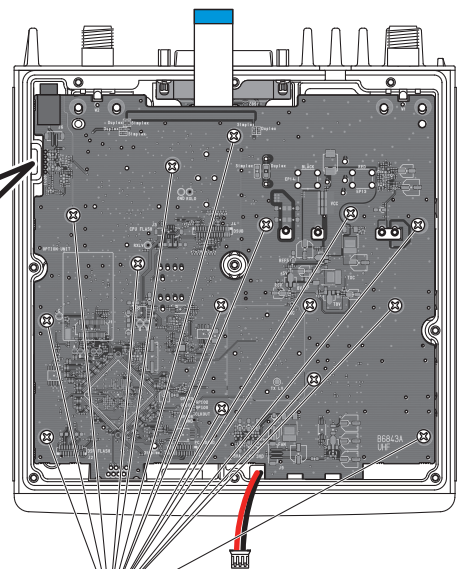
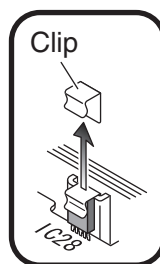

15 screws

SECTION 4 OPTIONAL UNIT INSTALLATION

Install UT-109R or UT-110R as follows.

- ① Disassembly the repeater until the MAIN UNIT is exposed. (See the page 3-1)
- ② Modify the patterns on the MAIN UNIT as below.

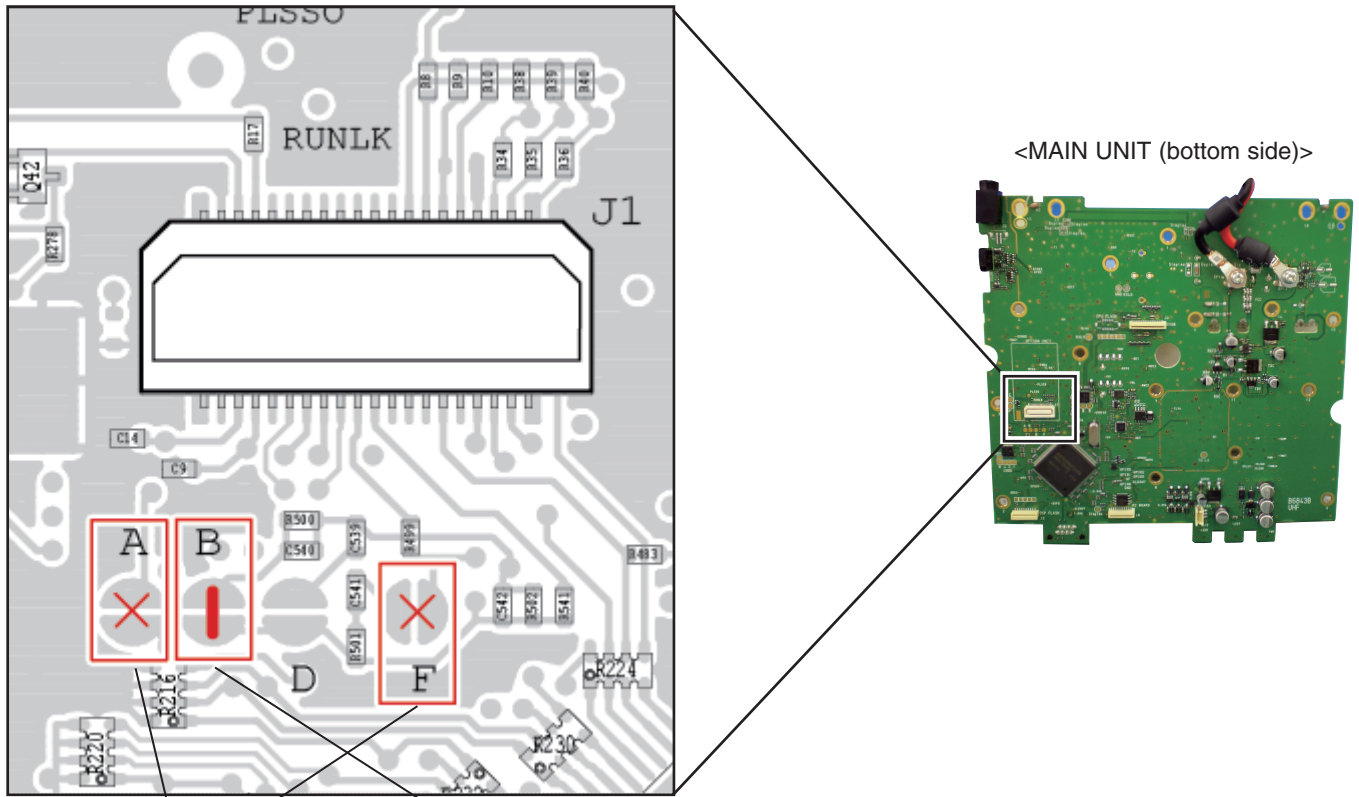

A and F; Cut the pattern

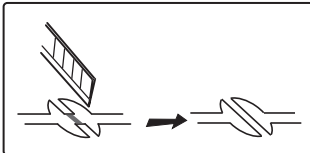

B; Short the pattern

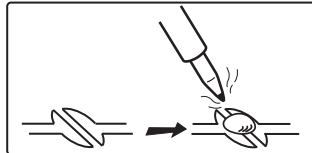

- ③ Remove the protective paper of optional unit, and install it to the J1 as below.

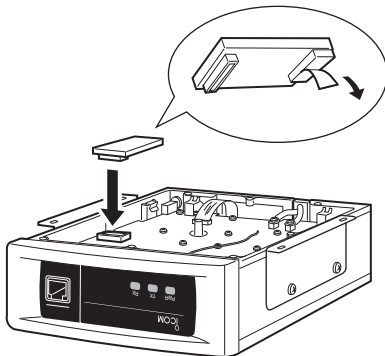

- ④ Replace the cover, screws, etc. to recover the whole assembly.

NOTE: When uninstalling the scrambler unit

Be sure to recover the disconnected or connected points, otherwise no TX modulation or AF output is available.

5-1 RECEIVER CIRCUITS

RF BPF CIRCUITS

RX signals from the RX antenna connector (J11) are passed through the 1st stage of BPF (D28, 29, 31, 32, L44, 47) then amplified by the RF AMP (Q36). The amplified RX signals are passed through the 2nd stage of BPF (D28, 29, 31, 32, L44, 47) to remove unwanted signals for good image response then applied to the 1st mixer (L27, 32, D62).

Being mixed with 1st LO signals from the RX VCO, the RX signals are converted into the 46.35 MHz 1st IF signal.

The 1st and 2nd stage of the BPFs are tuned to the pass band frequency by tracking voltage "T1" and "T2" from the DAC (IC17). The gain of low noise RF AMP (Q36) is controlled by the AGC circuit (Q39, D27) according to the RX signal strength.

IF FILTER/IF AMP CIRCUITS

The 1st IF signal from the 1st mixer (L27, 32, D62) is amplified by the buffer AMP (Q63, 64, 71) and 1st stage of IF AMP (Q19) then filtered by crystal filter (FI3 or FI4), and then applied to the IF IC (IC5).

The crystal filters (FI3 or FI4) are switched by the "NWC1" signal from the CPU (IC20) according to the RX mode; Wide (Middle), Narrow or Digital.

<ANALOG RX>

Being mixed with the 2nd LO, the 1st IF signal is converted into the 450 kHz 2nd IF signal. The 2nd IF signal is passed through the external ceramic filter (FI1 or FI2), then FM-demodulated by the internal quadrature detector with discriminator (X3). The demodulated AF signals are amplified by the AF AMP (IC36), and applied to the LINER CODEC (IC8). The AF signals are converted into the digital audio signal then processed by the DSP (IC12) then recovered to the analog audio signals.

The ceramic filter (FI1 or FI2) is switched by the "NWC2" signal from the CPU (IC20) according to the RX mode; Wide (Middle), Narrow or Digital.

<DIGITAL RX>

The 450 kHz 2nd IF signal is amplified by IC7 then applied to the DSP (IC12) via ADC (IC9), and digital-demodulated. The processed digital signal is converted into the analog audio signal by the LINEAR CODEC (IC8).

AF AMPLIFIER CIRCUITS

The AF signals from the LINEAR CODEC are amplified by the AF AMP (IC36) and level-adjusted by DAC (IC2), then applied to IC28 via IC29 to be power-amplified.

SIGNALING (DECODE)

The Continuous Tone (CTCSS/DTCS), Single Tone (5-Tone/DTMF/CW_ID) signals in the demodulated AF signals are decoded in the DSP (IC8).

5-2 TRANSMITTER CIRCUITS

MODULATION CIRCUITS

The demodulated signals are applied to the MIC AMP (IC25). The amplified Demodulated signals are passed through the SW IC (IC35) which selects the source of Demodulated signals from J5 (from MIC) and from D-SUB connector (DEXM).

The Demodulated signals from the SW IC are amplified by an AMP (IC1) then applied to the LINEAR CODEC IC (IC8) where the Demodulated signals are converted in to the digital audio signals.

The converted digital audio signals are processed (pre-emphasis, limit, etc.) by the DSP (IC12), then recovered to the analog audio signals by LINER CODEC IC (IC8). The AF signals are amplified by IC1 and level-adjusted by Electronic VR (IC2), then applied to the TX VCO and TCXO (X1) as the modulation signals.

SIGNALING (ENCODE)

The Continuous Tone (CTCSS/DTCS), Single Tone (5-Tone/DTMF/CW_ID) signals are encoded, and mixed with Demodulated signals in the DSP (IC12).

YGR/PA CIRCUITS

The output signals from TX VCOs are amplified to the level required for the PA module by pre-AMPs (Q37, 38), then amplified by the PA module (IC22) to obtain TX output power. The power-amplified TX signal is passed through the ANT SW (D44) and LPF (for harmonics removal) then applied to the TX antenna.

APC CIRCUIT

D45, D48 and D49 detect the TX power, and the detected voltage is applied to the IC23 in APC circuit. Comparing the detected voltage which is in proportion to the TX power and power setting voltage as the reference voltage, IC23 adjusts the bias voltage of PA module (pin 2: VGG terminal) and pre-AMP (Q38) to control the TX power.

5-3 FREQUENCY SYNTHESIZER CIRCUITS

RX PLL CIRCUIT

The RX PLL IC (IC4) outputs resulting signal; phase-comparison of reference signal (15.3 MHz) from the TCXO (X2) and feedback OSC signal from the RX VCO. The phase-difference signal is passed through the active loop filter (Q11, 14) and applied to the RX VCO as the lock voltage. The voltage of RX LV (lock voltage) is adjusted to appropriate one by "RX LVA" signal.

A portion of reference frequency signal (15.3 MHz) from the TCXO (X2) is passed through the tripler (Q2) to extract 3rd harmonic, then applied to the IF IC (IC5).

RX VCO

There are 2 VCOs; VCO for lower band (Q21, D8, 16, L17) and higher band (Q20, D7, 15, L20), and these VCOs (=OSC freq.) are switched by the VCO SW (Q26, 30). The OSC frequencies of these VCOs are adjusted (=Locked) to desired one by the RX LV signal (Lock Voltage). The output signals of these VCOs are applied to the 1st mixer (L27, 32, D62) via buffer (Q25).

A portion of output signal from the buffer (Q25) is applied to the doubler (Q32) to extract 2nd harmonic, then applied to the PLL IC (IC4) via the LPF.

TX PLL CIRCUIT

TX PLL IC (IC3) outputs resulting signal; phase-comparison of reference signal (15.3 MHz) from the TCXO (X1) and feedback OSC signal from the TX VCO. The phase-difference signal from the PLL IC (IC3) is passed through the active loop filter (Q10, 13) and applied to the TX VCO as the lock voltage. The lock voltage "TX LV" is adjusted to appropriate one by the LVA signal. The OSC signal of TCXO (X1) is FM-modulated by applied modulation signals.

TX VCO CIRCUITS

There are 2 VCOs; VCO for lower band (Q23, D10, 14, L62) and higher band (Q22, D9, 13, L14), and these VCOs (=OSC frequencies) are switched by the VCO SW (Q27, 28). The OSC frequencies of these VCO are adjusted (=Locked) to desired one by the TX LV signal (Lock Voltage).

The modulation signals applied to the Variable Capacitor (VD; D18 or D30) vary the capacitor reactance of it for FM modulation. The output signals of these VCOs are applied to the YGR/PA circuits via buffers (Q24, 35).

A portion of these output signal is passed through the doubler (Q33) to extract 2nd harmonic, then applied to the PLL IC (IC3) via the LPF.

5-4 OTHER CIRCUITS

POWER SUPPLY

The power supply is switched by Q57 (ON/OFF). 5V (REF5) from the regulator (IC30) is passed through L58 to supply to CPU. The 5V also supplies to other sections of the repeater via Q41 as "+5V."

8V from the regulator (IC27) are supplies to various circuits, and also supplies to TX circuits as "T8V" and RX circuits as "8V."

5V from the regulator (IC39) supplies DSP as "DSP5" and supplies logic circuits; CPU, DSP, etc. via regulators (IC13, 14, 15).

The regulator "F8V" (IC41) provides the supply for FRONT UNIT.

COMPANDER

The compander in the DSP (IC12) compresses the amplitude of Demodulated signals in TX, and expands in RX to provide high quality, high S/N ratio recovered sounds.

LEDs

DS1 (BUSY), DS2(PWR) and DS3 (TX) indicate the repeater's status: Power ON, T/RX and Cloning.

5-5 CPU (M: IC20) PORT ALLOCATION

Pin No.	LINE NAME	DESCRIPTION	IN/OUT	CONDITION
1–11	D5–D15	DSP data bus line.	I/O	–
15–28	A1–A14	DSP data bus line.	I/O	–
29	HRW	DSP data line.	I/O	–
32	FANS	Cooling fan (CH: MF1) rotation detect.	I	"H"=While the cooling fan is rotating.
33	TLED	TX indicator LED control signal.	O	"H"=TX
34	LEDR	RX indicator LED control signal.	O	"H"=Squelch open.
35	PLSCK	PLL (M: IC4) serial clock.	O	–
36	PLSSO	PLL (M:IC4) serial data.	O	–
41	PWON	Power line "VCC" control signal.	O	"H"=Power ON.
42	AFON2	AF power AMP. (M: IC28) control signal.	O	"H"=AF power AMP ON.
43	AFON	AF output select signal.	O	"H"=AF signals are output from the [ACCESSORY CONNECTOR].
44	ESCL	Serial clock to the EEPROM (M: IC21).	O	–
45	ESDA	Serial data to the EEPROM (M: IC21).	O	–
46	TXC	TX power line "T8V" control signal.	O	"H"=TX
47	RXC	RX power line "R8V" control signal.	O	"H"=RX
48	RPLST	RX PLL (M: IC4) strobe.	O	–
49	TPLST	TX PLL (M: IC3) strobe.	O	–
50	RUNLK	RX PLL (M: IC4) unlock signal.	I	"L"=Unlocked
51	TUNLK	TX PLL (M: IC3) unlock signal.	I	"L"=Unlocked
52	XCTS	Serial data from the RS-232 line driver (M: IC26).	I	–
53	XRTS	Serial data to the RS-232 line driver (M: IC26).	O	–
55	EXDA	External D/A port.	O	–
56	BEEP	Beep sounds (square waves).	O	–
57–59	OPV3–OPV1	Optional unit detect.	I	–
60	MMUT	MIC mute signal to the installed optional unit.	O	"H"=MIC mute
61	HANG	Microphone hang-up detect.	I	"L"=Hang-up
62	PTT	[PTT] key input. (pull up)	I	–
63	RMUT	RX mute signal to the installed optional unit.	O	"H"=RX mute
64	EXAD	External A/D port.	I	–
65	TEMP	Temperature detect.	I	–
68	RLVIN	RX PLL lock voltage.	I	–
69	BATV	Voltage monitor (divided voltage of "VCC").	I	–
70	TLVIN	TX PLL lock voltage.	I	–
71	RSSI	RSSI signal from the IF IC (M: 5).	I	–
74	XTXD	External data to the RS-232 driver (M: IC26).	O	–
75	XRXD	External data from the RS-232 driver (M: IC26).	I	–
76	TMUT	TX mute signal.	O	"H"=TX mute
77	HINT	DSP IC control signal.	O	–
78	INT1	DSP IC control signal.	O	–
79	HRDY	DSP IC control signal.	O	–
81	HDS1	DSP IC control signal.	O	–
82	HDS2	DSP IC control signal.	O	–
100	RES	CPU reset signal from the reset IC (F: IC501).	O	–
101–108	EXIO1–EXIO8	External data bus line.	I/O	+5 V pull-up
112	POSW	[PWR] key input. (pull-up)	I	–
113	NOIS	Noise detect.	I	"H"=RX signal is absent (squelch close).
114	CSFT	Clock frequency shift signal.	O	–
119	SSO	Serial data to the seri-para converter (M: IC31).	O	–
120	SCK	Clock signal to the seri-para converter (M: IC31).	O	–
121	EXIO9	External data bus line.	I/O	+5 V pull-up
122	DSDA	Serial data to the DAC (M: IC17).	O	–

5-5 CPU (M: IC20) PORT ALLOCATION (continued)

Pin No.	LINE NAME	DESCRIPTION	IN/OUT	CONDITION
123	DAST	Strobe to the DAC (M: IC2).	O	–
125	FMDA	Data from the FRONT CPU (F: IC502).	I	–
126	MFDA	Data to the FRONT CPU (F: IC502).	O	–
127	OPT2	Port for optional unit.	O	–
128	OPT1	Port for optional unit.	I	–
129	OPT3	Port for optional unit.	I	–
131	CSO	Port for optional unit.	O	–
132	CSI	Port for optional unit.	I	–
133	EXOE	Output enable signal to the seri-para converter (M: IC31).	O	–
134	EXST	Strobe to the seri-para converter (M: IC31).	O	–
135	DRES	Reset signal to the DSP IC (M: IC12).	O	–
136	HCS	DSP data line.	I/O	–
138	GPIO2	DSP data line.	I/O	–
139	GPIO1	DSP data line.	I/O	–
140–144	D0–D4	DSP data bus line.	I/O	–

SECTION 6 ADJUSTMENT PROCEDURE

6-1 PREPARATION

■ REQUIRED EQUIPMENTS

EQUIPMENT	SPECIFICATION	EQUIPMENT	SPECIFICATION
Adjustment Software	"CS-FR5000" (Revision 1.0 or later)	JIG cable	Modified OPC-1122U (USB type) (see the illust below)
Power Supply	Output voltage : 13.6 V DC [UR-FR5000] 13.2 V DC [UR-FR5100] Current capacity : More than 20 A [UR-FR5000] More than 10 A [UR-FR5100]	Attenuator	Power attenuation : 40 dB Capacity : More than 60 W [UR-FR5000] More than 30 W [UR-FR5100]
RF Power Meter (terminated type)	Measuring range : 1–60 W [UR-FR5000] 1–30 W [UR-FR5100] Frequency range : 100–300 MHz Impedance : 50 Ω SWR : Less than 1.2 : 1	Standard Signal Generator (SSG)	Frequency range : 0.1–300 MHz Output level : 0.1 mV to 32 mV (–127 to –17 dBm)
		Audio Generator	Frequency range : 300–3000 Hz Output level : 1–500 mV
Frequency Counter	Frequency range : 0.1–300 MHz Frequency accuracy: ±1 ppm or better Input level : Less than 1 mW	AC Millivoltmeter	Measuring range : 10 mV to 10 V
		Oscilloscope	Frequency range : DC–20 MHz Measuring range : 0.01–20 V
Modulation Analyzer	Frequency range : 30–300 MHz Measuring range : 0 to ±10 kHz	External Speaker	Input impedance : 4 Ω Capacity : More than 5 W

■ JIG CABLE

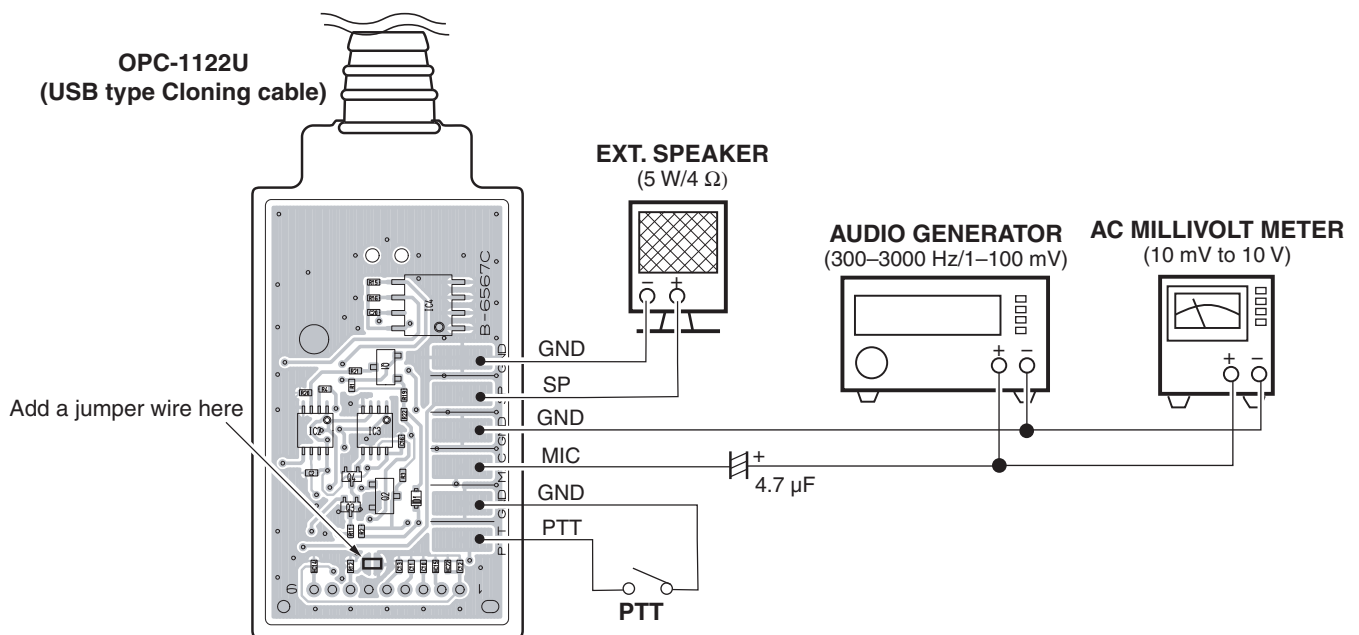

CONNECTION

NOTE: Installing your UR-FR5000/UR-FR5100 into an IC-FR5000/IC-FR5100 is necessary for adjustment.

FRONT VIEW

Turn the extended module's power ON
(see the IC-FR5000/IC-FR5100 Instruction Manual)

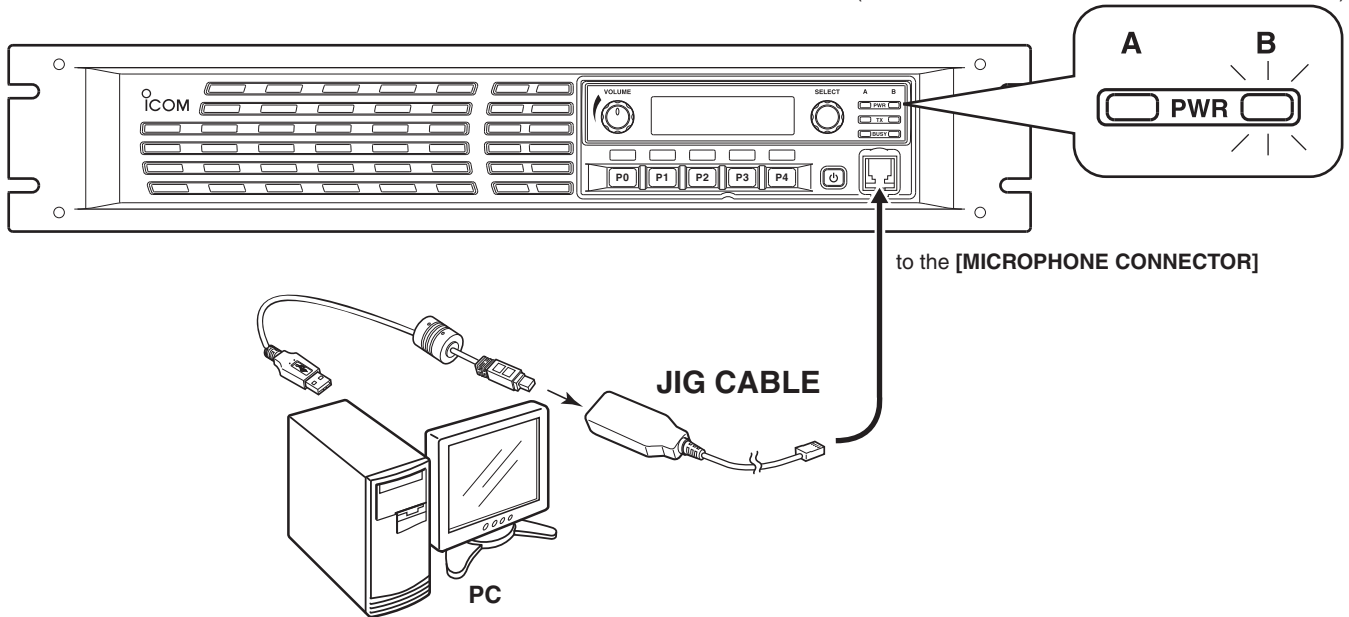

REAR VIEW

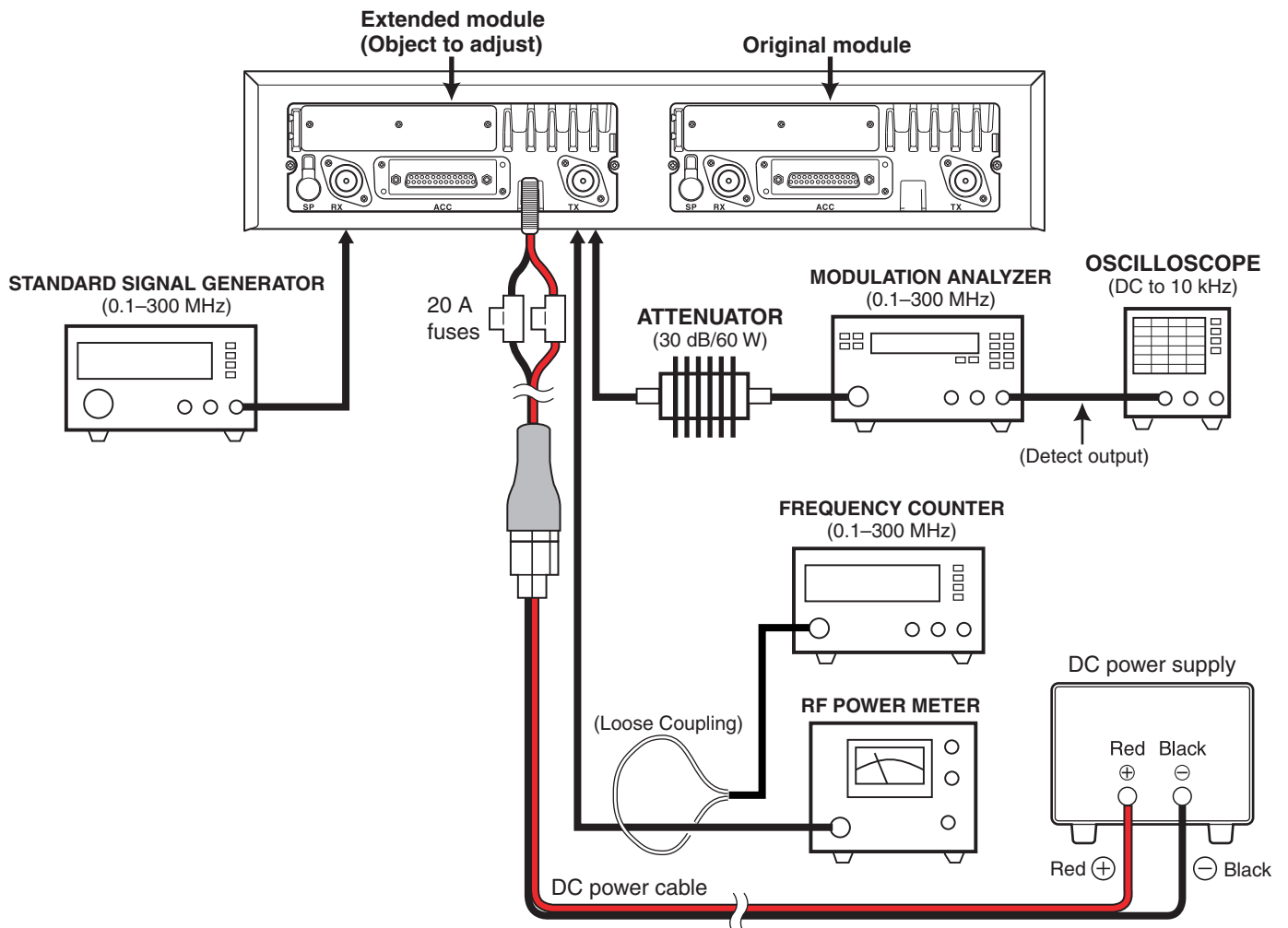

ADJUSTMENT CHANNEL LISTS

Clone the adjust channels into the repeater before starting adjustment. Each channel must be assigned [Frequency], [RF PWR], [CH Type], [TX C. Tone] and [W/N] as below.

• Channel list

Memory CH									
CH	Operation Mode	Frequency (MHz)			Text	TOT			L
		RX	TX	TX Inh		Local Mic	Repeat/EPTT	RF PWR	
1- 1	Simplex	154.900000	<-		RX LV L ADJ			L1	
1- 2	Simplex	173.900000	<-		RX LV H ADJ			L1	
1- 3	Simplex	136.100000	<-		TX LV L ADJ			L1	
1- 4	Simplex	155.000000	<-		TX LV H ADJ			L1	
1- 5	Simplex	136.100000	<-		RX LV L URFY			L1	
1- 6	Simplex	155.000000	<-		RX LV H URFY			L1	
1- 7	Simplex	154.950000	<-		TX LV L URFY			H	
1- 8	Simplex	173.900000	<-		TX LV H URFY			H	
1- 9	Simplex	173.900000	<-		TX Freq			L1	
1- 10	Simplex	136.100000	<-		TX PWR Hi			H	
1- 11	Simplex	136.100000	<-		TX PWR L2			L2	
1- 12	Simplex	136.100000	<-		TX PWR L1			L1	
1- 13	Simplex	145.500000	<-		BAL			L1	
1- 14	Simplex	164.500000	<-		BAL Offset			L1	
1- 15	Simplex	136.100000	<-		DG Dev.			L1	
1- 16	Simplex	142.200000	<-		DG Dev. 0			L1	
1- 17	Simplex	148.600000	<-		DG Dev. 1			L1	
1- 18	Simplex	154.900000	<-		DG Dev. 2			L1	
1- 19	Simplex	155.100000	<-		DG Dev. Offs			L1	
1- 20	Simplex	161.400000	<-		DG Dev. 3			L1	
1- 21	Simplex	167.800000	<-		DG Dev. 4			L1	
1- 22	Simplex	173.900000	<-		DG Dev. 5			L1	
1- 23	Simplex	136.100000	<-		AN Dev. W			L1	
1- 24	Simplex	136.100000	<-		AN Dev. M			L1	
1- 25	Simplex	136.100000	<-		AN Dev. N			L1	
1- 26	Simplex	136.100000	<-		CT/DT Dev.			L1	
1- 27	Simplex	136.100000	<-	i	BPF C ALL			L1	
1- 28	Simplex	173.900000	<-	i	BPF H ALL			L1	
1- 29	Simplex	173.900000	<-	i	RSSI			L1	
1- 30	Simplex	173.900000	<-	i	SQL			L1	

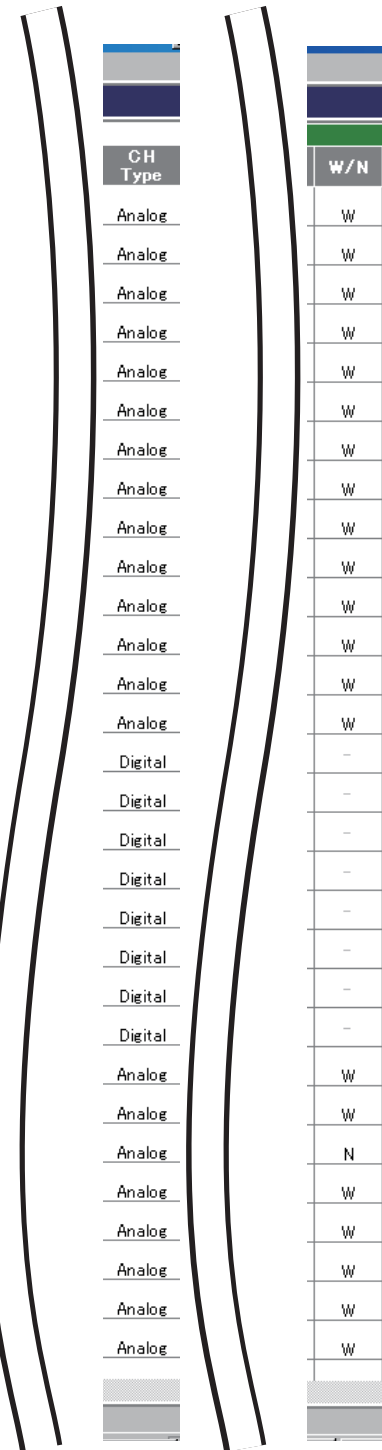

WHOLE PROCEDURE OF THE ADJUSTMENT

- ① Connect the repeater and PC with the JIG cable (see the page 6-2).
- ② Turn the repeater power ON.
- ③ Boot up 'CS-FR5000.'
- ④ Set the [Digital Function] to "Enable."

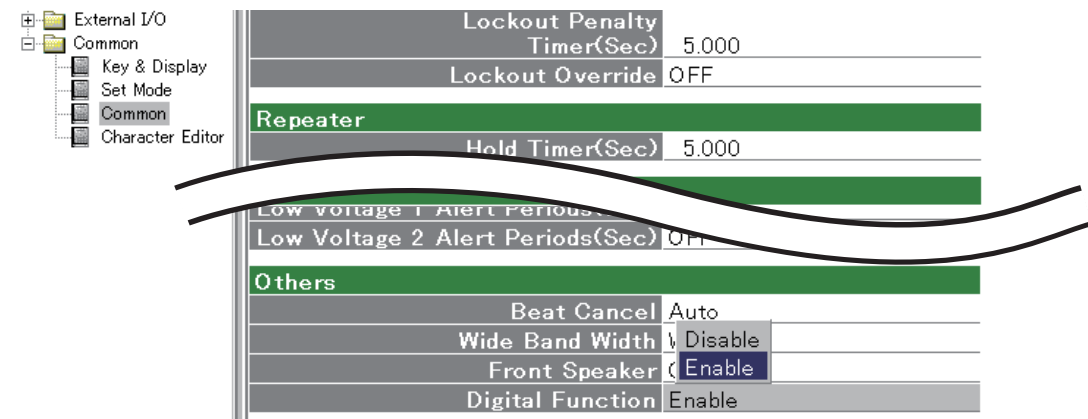

- ⑤ Click  or [Read ← TR] in the [Adjust] menu, then the "Adjust Utility" window (see the page 6-5) appears.

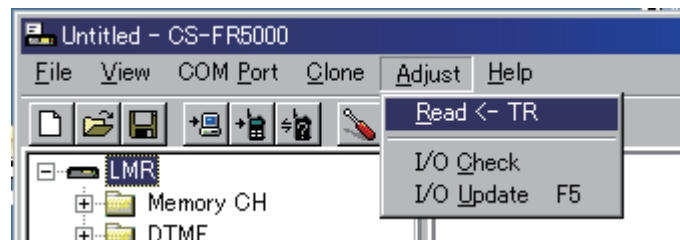

- ⑥ Set or modify adjustment values as specified in the guidances on the pages 6-6 to 6-9.

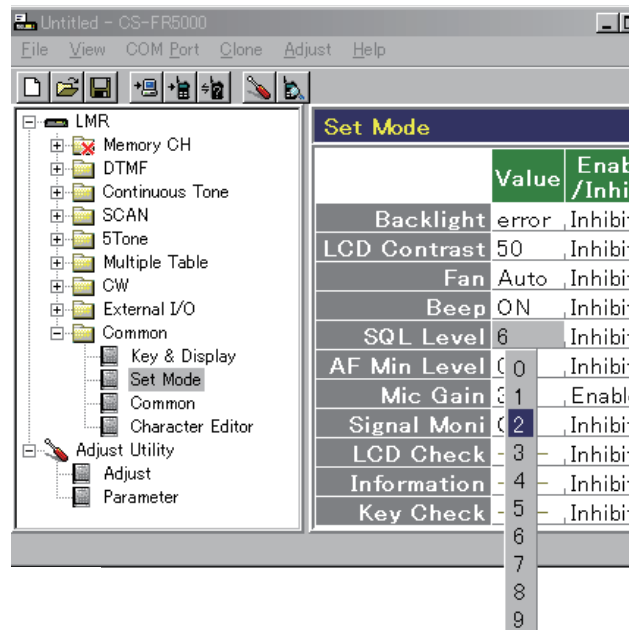

*For [UR-FR5100]:

Set the [Wide Band Width] to "Middle" when adjust "ANALOG DEVIATION" in Middle mode.

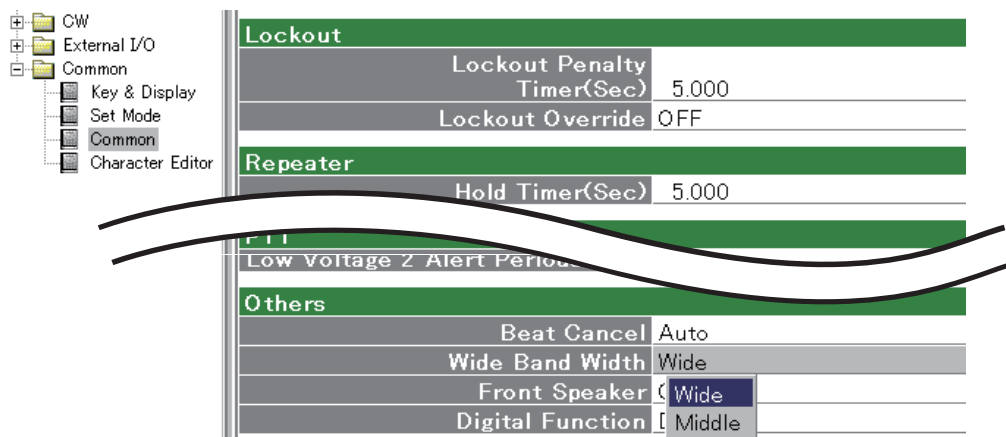

ADJUST UTILITY WINDOW

Adjust Utility

Setting			
	CH No.	1	Receive Sim
	RX Freq.		
	TX Freq.		
	RF Power.		Low Wide
	W/N		FX=Digital TX=Digital
	CH Type		Digital PNB Digital
Mode setting	TX Mode	17	
	RX Mode	2	
	AF Volume	0	[-----]
Adjust			
TX output power	Power (H)	208	[-----]
	Power (L2)	150	[-----]
	Power (L1)	76	[-----]
Analog deviation	MOD (Wide)	139	[-----]
	MOD (Mid)	144	[-----]
	MOD (Narrow)	65	[-----]
	MOD (Digital)	105	[-----]
CTCSS/DTCS deviation	CTCSS/DTCS	137	[-----]
	S.Tone	75	[-----]
Squelch	SQL	50	[---]
Expert			
TX frequency	RX REF	178	[-----]
	TX REF	126	[-----]
Lock volatge (Preset)	RX LVA L	80	[-----] [Enter] to Sweep
	RX LVA H	62	[-----] [Enter] to Sweep
	TX LVA L	166	[-----] [Enter] to Sweep
	TX LVA H	105	[-----] [Enter] to Sweep
Lock volatge (Adjustment)	LV (RX L)	36	0.70V
	LV (RX H)	36	0.70V
	LV (TX L)	36	0.70V
	LV (TX H)	36	0.70V
S-meter	RSSI	74	[Enter] to Capture
Modulation balance	BAL	174	[-----]
	BAL Offset (High)	0	[-----]
Modulation balance (High)	PWR Hi Slant Band 0	0	[-----]
	PWR Hi Slant Band 1	3	[-----]
	PWR Hi Slant Band 2	4	[-----]
	PWR Hi Slant Band 3	25	[-----]
	PWR Hi Slant Band 4	8	[-----]
	PWR Hi Slant Band 5	6	[-----]
	PWR Hi Slant Band 6	0	[-----]
	PWR L2 Slant Band 0	0	[-----]
	PWR L2 Slant Band 1	4	[-----]
	PWR L2 Slant Band 2	4	[-----]
	PWR L2 Slant Band 3	17	[-----]
	PWR L2 Slant Band 4	8	[-----]
	PWR L2 Slant Band 5	6	[-----]
	PWR L2 Slant Band 6	0	[-----]
	PWR L1 Slant Band 0	0	[-----]
	PWR L1 Slant Band 1	0	[-----]
	PWR L1 Slant Band 2	2	[-----]
	PWR L1 Slant Band 3	14	[-----]
PWR L1 Slant Band 4	6	[-----]	
PWR L1 Slant Band 5	4	[-----]	
PWR L1 Slant Band 6	0	[-----]	
Digital deviation	MOD Slant Band 0	0	[-----]
	MOD Slant Band 1	-9	[-----]
	MOD Slant Band 2	-13	[-----]
	MOD Slant Band 3	-2	[-----]
	MOD Slant Band 4	-5	[-----]
	MOD Slant Band 5	2	[-----]
	MOD Slant Band 6	0	[-----]
	MOD Offset (High)	0	[-----]
Receive sensitivity (Band center)	BPF C ALL		[Enter] to Sweep
	BPF T1 C	4	[-----] [Enter] to Sweep
	BPF T2 C	25	[-----] [Enter] to Sweep
	BPF L ALL		[Enter] to Sweep
	BPF T1 L	80	[-----] [Enter] to Sweep
	BPF T2 L	45	[-----] [Enter] to Sweep
	BPF H ALL		[Enter] to Sweep
Receive sensitivity (Band high)	BPF T1 H	69	[-----] [Enter] to Sweep
	BPF T2 H	53	[-----] [Enter] to Sweep

6-2 FREQUENCY ADJUSTMENT

- 1) Select an adjustment item using cursor or [↑] / [↓] keys of the PC's keyboard.
- 2) Set or modify the adjustment value as specified using [←] / [→] keys of the PC's keyboard, then push the [ENTER] key.

ADJUSTMENT	ADJUSTMENT CONDITION	OPERATION	ADJUSTMENT ITEM	VALUE			
PLL LOCK VOLTAGE -Preparation-	1	-	[LV (RX L)]	161 [3.15V]			
			[LV (RX H)]	153 [3.00V]			
			[LV (TX L)]	51 [1.0V]			
			[LV (TX H)]	36 [0.7V]			
-Adjust-RX (Band center)	2	• CH. : 1-1 • Receiving	• Select the item [RX LVA L], then push the [ENTER] key.	[RX LVA L]	(Automatic adjustment)		
RX (Band high)	3	• CH. : 1-2 • Receiving	• Select the item [RX LVA H], then push the [ENTER] key.	[RX LVA H]			
TX (Band low)	4	• CH. : 1-3 • Transmitting	• Select the item [TX LVA L], then push the [ENTER] key.	[TX LVA L]			
TX (Band center)	5	• CH. : 1-4 • Transmitting	• Select the item [TX LVA H], then push the [ENTER] key.	[TX LVA H]			
LOCK VOLTAGE VERIFY	1	• CH. : 1-5 • Receiving	• Verify the lock voltage at each channels on the [RX LIVIN] item on the "I/O Check window" as below.	[RX LIVIN] (I/O Check window)	0.5–1.5 V (Verify)		
RX (Band low)							
RX (Band center)						2	• CH. : 1-6 • Receiving
TX (Band center)						3	• CH. : 1-7 • Transmitting
TX (Band high)	4	• CH. : 1-8 • Transmitting			2.0–3.5 V (Verify)		
TX FREQUENCY	1	-	1) Set the item [TX Mode] to "1." 2) Connect an RF power meter to the TX antenna.	[TX Mode]	"1"		
	2	• CH. : 1-9 • Transmitting	1) Adjust the frequency using [←] / [→] keys of the PC's keyboard. 2) Push the [ENTER] key to store the adjust value.	[TX REF]	173.9000 MHz		

• I/O CHECK WINDOW

I/O Check			
Input	Dec	Hex	Data
VIN	180	B4	14.12V
TEMPS	100	06	38.31°C
RX LIVIN	116	74	2.27V
TX LIVIN	219	DB	4.29V
SD	28	1C	0.53V
Output	Dec	Hex	Data
BPF T1	165	A5	3.24V
BPF T2	253	FD	4.96V
RF POWER	0	0	0.00V
RX LVA	165	A5	3.24V
TX LVA	145	91	2.84V
RX REF	77	4D	1.51V
TX REF	126	7E	2.47V
MOD BAL	0	0	0.00V
DEV	43	2B	0.84V
FANV	255	FF	5.00V

Lock voltage verify

*The above voltages are just an example.

6-3 TRANSMIT ADJUSTMENT

1) Select an adjustment item using cursor or [↑] / [↓] keys of the PC's keyboard.

2) Set or modify the adjustment value as specified using [←] / [→] keys of the PC's keyboard, then push the [ENTER] key.

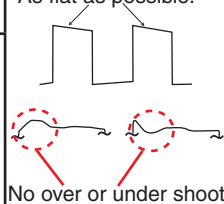
ADJUSTMENT		ADJUSTMENT CONDI-TION	OPERATION	ADJUST-MENT ITEM	VALUE
TX Output Power -Preparation-	1	-	• Connect an RF power meter to the TX antenna connector.	-	-
-Adjust- (Hi Power)	2	• CH. : 1-10 • Transmitting	1) Adjust the TX output power using [←] / [→] keys of the PC's keyboard. 2) Push the [ENTER] key to store the adjust value.	[Power(Hi)]	50 W [FR5000] 25 W [FR5100]
(L2 Power)	3	• CH. : 1-11 • Transmitting		[Power(L2)]	25 W [FR5000] 10 W [FR5100]
(L1 Power)	4	• CH. : 1-12 • Transmitting		[Power(L1)]	5 W [FR5000] 2.5 W [FR5100]
MODULATION BALANCE -Preparation-	1	• Connect a Modulation Analyzer to the TX antenna connector through an attenuator.	• Set the Modulation Analyzer as; HPF : OFF LPF : 20 kHz De-emphasis : OFF Detector : (P-P)/2	-	-
	2	-	• Set the item [TX Mode] to "2."	[TX Mode]	"2"
-Adjust- (TX VCO 1)	3	• CH. : 1-13 • Transmitting	1) Adjust the wave form using [←] / [→] keys of the PC's keyboard. 2) Push the [ENTER] key to store the adjust value.	[BAL]	As flat as possible. 
(TX VCO 2)	4	• CH. : 1-14 • Transmitting		[BAL Offset (High)]	
DIGITAL DEVIATION -Preparation-	1	-	• Set the item [TX Mode] to "16."	[TX Mode]	"16"
	2	• Connect a Modulation Analyzer to the TX antenna connector through an attenuator.	• Set the Modulation Analyzer as; HPF : OFF LPF : 20 kHz De-emphasis : OFF Detector : (P-P)/2	-	-
-Adjust- (Band 1)	3	• CH. : 1-15 • Transmitting	1) Adjust the deviation using [←] / [→] keys of the PC's keyboard. 2) Push the [ENTER] key to store the adjust value.	[MOD (Digital)]	±1.39–1.43 kHz
(Band 2)	4	• CH. : 1-16 • Transmitting		[MOD Slant Band 0]	
(Band 3)	5	• CH. : 1-17 • Transmitting		[MOD Slant Band 1]	
(Band 4)	6	• CH. : 1-18 • Transmitting		[MOD Slant Band 2]	
(Band 5)	7	• CH. : 1-19 • Transmitting		[MOD Offset (High)]	
(Band 6)	8	• CH. : 1-20 • Transmitting		[MOD Slant Band 3]	
(Band 7)	9	• CH. : 1-21 • Transmitting		[MOD Slant Band 4]	
(Band 8)	10	• CH. : 1-22 • Transmitting		[MOD Slant Band 5]	

6-3 TRANSMIT ADJUSTMENT (continued)

1) Select an adjustment item using cursor or [↑] / [↓] keys of the PC's keyboard.

2) Set or modify the adjustment value as specified using [←] / [→] keys of the PC's keyboard, then push the [ENTER] key.

ADJUSTMENT	ADJUSTMENT CONDITION	OPERATION	ADJUSTMENT ITEM	VALUE
ANALOG DEVIATION -Preparation-	1	–	• Set the item [TX Mode] to "1."	[TX Mode] "1"
	2	• Connect a Modulation Analyzer to the TX antenna connector through an attenuator.	• Set the Modulation Analyzer as; HPF : OFF LPF : 20 kHz De-emphasis : OFF Detector : (P-P)/2	– –
	3	• Connect an Audio Generator to the MIC line through the JIG cable.	• Set the Audio Generator as; Modulation : 1050 Hz Level : 40 mVrms Waveform : Sine wave	– –
-Adjust- (Wide)	4	• CH. : 1-23 • Transmitting	1) Adjust the deviation using [←] / [→] keys of the PC's keyboard. 2) Push the [ENTER] key to store the adjust value.	[MOD (Wide)] ±4.05–4.15 kHz
(Middle) <[FR5100] only>	5	• CH. : 1-24 • [Wide Band Width] : "Middle" (see the page 6-4) • Transmitting		[MOD (Middle)] ±3.15–3.25 kHz
(Narrow)	6	• CH. : 1-25 • Transmitting		[MOD (Narrow)] ±2.05–2.15 kHz
CTCSS/DTCS DEVIATION -Preparation-	1	–	• Set the item [TX Mode] to "3."	[TX Mode] "3"
-Adjust-	2	• CH. : 1-26 • Transmitting	1) Adjust the deviation using [←] / [→] keys of the PC's keyboard. 2) Push the [ENTER] key to store the adjust value.	[CTCSS] ±0.68–0.72 kHz

6-4 RECEIVE ADJUSTMENT

1) Select an adjustment item using cursor or [↑] / [↓] keys of the PC's keyboard.

2) Set or modify the adjustment value as specified using [←] / [→] keys of the PC's keyboard, then push the [ENTER] key.

ADJUSTMENT	ADJUSTMENT CONDITION	OPERATION	ADJUSTMENT ITEM/POINT	VALUE
RECEIVE SENSITIVITY -Preparation-	1	–	• Set the item [RX Mode] to "1."	[RX Mode] "1"
	2	• Connect an SSG to the RX antenna connector.	• Set the SSG as; Level : +20 dBμ Modulation : 1 kHz Deviation : 3.5 kHz	– –
-Adjust- (Band center)	3	• CH. : 1-27 • Receiving	1) Set the SSG as; Frequency : 136.100 MHz 2) Select the item [BPF C ALL], then push the [ENTER] key.	[BPF C ALL] (Automatic adjustment)
(Band high)	4	• CH. : 1-28 • Receiving	• Set the preset adjustment value on the adjustment utility window.	[BPFT1 H] "115"
				[BPFT2 H] "165"

6-4 RECEIVE ADJUSTMENT (continued)

1) Select an adjustment item using cursor or [↑] / [↓] keys of the PC's keyboard.

2) Set or modify the adjustment value as specified using [←] / [→] keys of the PC's keyboard, then push the [ENTER] key.

ADJUSTMENT	ADJUSTMENT CONDITION	OPERATION	ADJUSTMENT ITEM/POINT	VALUE	
S-METER -Preparation-	NOTE: "RECEIVE SENSITIVITY" MUST be adjusted before "S-METER." When "RECEIVE SENSITIVITY" is re-adjusted, "S-METER" MUST be re-adjusted too.				
	1	• Connect an SSG to the RX antenna connector.	• Set the SSG as; Frequency : 173.900 MHz Modulation : 1 kHz Deviation : 3.5 kHz	-	-
-Adjust- (S3 level)	2	• CH. : 1-29 • Receiving	1) Set the SSG as; Level : +23 dB _μ 2) Select the item [RSSI S3 Level] , then push the [ENTER] key to store the adjust value.	[RSSI S3 Level]	(Automatic adjustment)
(S1 level)	3	• CH. : 1-29 • Receiving	1) Set the SSG as; Level : -7 dB _μ 2) Select the item [RSSI S1 Level] , then push the [ENTER] key, to store the adjust value.	[RSSI S1 Level]	(Automatic adjustment)
SQUELCH	1	• CH. : 1-30	• Set the item [SQL Level] to "2."	[SQL Level]	"2"
	2	• Receiving	• Set the preset adjustment value on the adjustment utility window.	[SQL]	"35"

SECTION 7

PARTS LIST

[MAIN UNIT]

REF NO.	ORDER NO.	DESCRIPTION	M.	H/V LOCATION
IC1	1110005330	S.IC NJM12904V-TE1-#ZZZB	T	58.1/71.4
IC2	1110007290	S.IC AK2330P-L	T	58.7/56.1
IC3	1130010100	S.IC LMX2352TMX/NOPB	B	120.2/43.9
IC4	1130010100	S.IC LMX2352TMX/NOPB	B	28/78.8
IC5	1110003491	S.IC TA31136FNG (D,EL)	B	70.4/82.5
IC7	1110007280	S.IC NJM2716F-TE1-#ZZZB	B	56.8/46.4
IC8	1130012910	S.IC AK4554VTP-E2/P	B	36.2/59.9
IC9	1190002080	S.IC AD7474ARTZ-500RL7	B	49.6/46.4
IC10	1130013040	S.IC TC7WBD125AFK (T5L,F)	B	46.6/49.2
IC11	1110006230	S.IC NJM2711F-TE1-#ZZZB	B	53.1/35
IC12	1140013290	S.IC TMS320VC5509AZHH	B	33.3/37.8
IC13	1180002590	S.REG XC6204B332MR	T	80.9/21.3
IC14	1180003270	S.REG R1114Q161D-TR-F	T	84.4/21.4
IC15	1180002590	S.REG XC6204B332MR	T	87.8/21.3
IC17	1190001340	S.IC M62334FP 600C	T	67.3/61.7
IC18	1110005771	S.IC S-80942CNMC-G9CT2G	T	41.2/52.8
IC19	1180003210	S.REG NJM2831F10	B	111/26.2
IC20	1140014550	S.IC HD64F2506RFC26DV	T	33.5/37.6
IC21	1140012950	S.IC 24LC512T-ISM	T	59.1/21.8
IC22	1150002042	IC RA30H1317M-121 [EUR-01]		
	1150002073	IC RA60H1317M-125 [USA-01], [EXP-01]		
IC23	1110002751	S.IC TA75S01F (TE85R,F)	T	141.7/125.1
IC25	1130008561	S.IC TC75S51F (TE85L,F)	B	29/16.3
IC26	1120003070	S.IC MAX3232EIPWR	T	42.7/70
IC27	1180001251	S.IC TA7808F (TE16L,Q)	T	114.4/85
IC28	1110003091	IC LA4425A-E		
IC29	1110002751	S.IC TA75S01F (TE85R,F)	T	12/123.1
IC30	1110003390	S.IC AN8005M-(E1)	T	98.3/91.4
IC31	1130011760	S.IC CD4094BPWR	T	8.1/45.2
IC32	1130013360	S.IC AT25F2048N-10SU-2.7SL383	B	8.9/36.1
IC34	1110005340	S.IC NJM12902V-TE1-#ZZZB	B	12.2/58.2
IC35	1140013200	S.IC CD4053BPWR	B	20.6/58.2
IC36	1110005330	S.IC NJM12904V-TE1-#ZZZB	B	27.8/55.4
IC37	1120002830	S.IC NJM2125F-TE1-#FZZB	T	56.6/66.7
IC38	1110006380	S.IC LM2904PWR	T	114.1/23.8
IC39	1180001071	S.IC TA7805F (TE16L,Q)	T	101.2/24.3
IC40	1110005330	S.IC NJM12904V-TE1-#ZZZB	B	50.6/57.2
IC41	1180001251	S.IC TA7808F (TE16L,Q)	B	132/16.7
Q1	1590003230	S.STR UNR9113J-(TX)	B	53.4/79.7
Q2	1530002851	S.STR 2SC4116-BL (TE85R,F)	B	34.9/77.7
Q3	1560001360	S.FET 2SK3019 TL	B	66.4/76.3
Q5	1560000541	S.FET 2SK880-Y (T5RICOM,F)	B	35.7/107.1
Q7	1530002601	S.STR 2SC4215-O (TE85R,F)	B	73/92.9
Q8	1560000541	S.FET 2SK880-Y (T5RICOM,F)	B	89.5/46
Q9	1560001360	S.FET 2SK3019 TL	B	39.6/103.6
Q10	1530002851	S.STR 2SC4116-BL (TE85R,F)	B	89.5/43.5
Q11	1530002851	S.STR 2SC4116-BL (TE85R,F)	B	30.6/104.2
Q12	1590003230	S.STR UNR9113J-(TX)	B	66.1/100.3
Q13	1530002851	S.STR 2SC4116-BL (TE85R,F)	B	84.7/43.5
Q14	1530002851	S.STR 2SC4116-BL (TE85R,F)	B	30.6/107.1
Q15	1530002851	S.STR 2SC4116-BL (TE85R,F)	B	96.9/44.4
Q16	1530002851	S.STR 2SC4116-BL (TE85R,F)	T	35.2/108.3
Q19	1530002601	S.STR 2SC4215-O (TE85R,F)	B	63.2/106.8
Q20	1530002920	S.STR 2SC4226-T1 R25	B	39.9/123.1
Q21	1530002920	S.STR 2SC4226-T1 R25	B	39.6/114.5
Q22	1530002920	S.STR 2SC4226-T1 R25	B	95.2/64.3
Q23	1530002920	S.STR 2SC4226-T1 R25	B	95.2/54.5
Q24	1530003311	S.STR 2SC5107-O (TE85R,F)	B	100.6/58.6
Q25	1530003311	S.STR 2SC5107-O (TE85R,F)	B	44.9/117.4
Q26	1590001400	S.STR XP1214 (TX)	B	40.5/117.8
Q27	1590001400	S.STR XP1214 (TX)	B	96/59.6
Q28	1590003290	S.STR UNR9213J-(TX)	B	93.3/59.6
Q29	1590003290	S.STR UNR9213J-(TX)	T	57.2/41.9
Q30	1590003290	S.STR UNR9213J-(TX)	B	37.8/117.8
Q31	1590003230	S.STR UNR9113J-(TX)	T	57.2/39.8
Q32	1530003311	S.STR 2SC5107-O (TE85R,F)	B	46.2/111.7
Q33	1530003311	S.STR 2SC5107-O (TE85R,F)	B	101.9/53
Q34	1530003311	S.STR 2SC5107-O (TE85R,F)	B	46.2/123.1
Q35	1530003311	S.STR 2SC5107-O (TE85R,F)	B	101.9/64.4
Q36	1580000731	S.FET 3SK293 (TE85L,F)	B	48.3/136.6
Q37	1530003311	S.STR 2SC5107-O (TE85R,F)	B	132.4/84.5
Q38	1530002680	S.STR 2SC3357-T1	B	139.5/86
Q39	1560000841	S.FET 2SK1829 (TE85R,F)	B	54.2/142.5
Q40	1590001190	S.STR XP6501-(TX).AB	T	101.6/87.4
Q41	1520000460	S.STR 2SB1132 T100 R	T	101.6/82.8
Q42	1590003290	S.STR UNR9213J-(TX)	T	13.3/67.6
Q43	1590003290	S.STR UNR9213J-(TX)	T	137.3/125
Q44	1590003290	S.STR UNR9213J-(TX)	T	114.3/80.1
Q45	1540000550	S.STR 2SD1664 T100Q	T	118.4/75.2
Q46	1530002851	S.STR 2SC4116-BL (TE85R,F)	T	137.3/120.2
Q48	1510000920	S.STR 2SA1577 T106 Q	T	101.5/77.8
Q49	1590003290	S.STR UNR9213J-(TX)	T	102.2/73.7
Q52	1590003290	S.STR UNR9213J-(TX)	T	10.9/131.6
Q53	1590003290	S.STR UNR9213J-(TX)	T	10.9/129.6
Q56	1590003321	S.FET TPC6103 (TE85L,F)	T	7.6/132.6
Q57	1550000100	S.FET 2SJ377 (TE16L1,NQ)	T	123.3/99.6
Q58	1590003290	S.STR UNR9213J-(TX)	T	129.4/102.2
Q59	1590000990	S.STR DTC363EK T146	T	7.6/127.6
Q61	1530002851	S.STR 2SC4116-BL (TE85R,F)	T	6.8/118.4
Q62	1540000441	S.STR 2SD1619T-TD-E	T	118.4/18.6
Q63	1560000990	S.FET PMBFJ310	B	66.3/110
Q64	1560000990	S.FET PMBFJ310	B	63.4/110
Q65	1530003311	S.STR 2SC5107-O (TE85R,F)	B	59.6/123.7
Q66	1590003290	S.STR UNR9213J-(TX)	B	94.9/4.7
Q67	1590003290	S.STR UNR9213J-(TX)	B	124.9/4.7

[MAIN UNIT]

REF NO.	ORDER NO.	DESCRIPTION	M.	H/V LOCATION
Q68	1590003290	S.STR UNR9213J-(TX)	T	109.9/4.7
Q69	1590003290	S.STR UNR9213J-(TX)	B	9.5/53.3
Q70	1590003230	S.STR UNR9113J-(TX)	T	9.5/51
Q71	1560000990	S.FET PMBFJ310	B	60.5/110
Q72	1530002851	S.STR 2SC4116-BL (TE85R,F)	B	107/26.3
D1	1750001070	S.DIO DAN235ETL	B	57.3/78.6
D2	1750001070	S.DIO DAN235ETL	B	50/79.7
D3	1790001621	S.DIO 1SV308 (TPL3,F)	B	69.3/94.8
D4	1790001621	S.DIO 1SV308 (TPL3,F)	B	69.3/92.2
D5	1720000641	S.VCP 1SV284 (TPH3,F)	B	29.9/120.1
D7	1720000791	S.VCP HVC321B1TRF-E	B	28.6/125.1
D8	1720000791	S.VCP HVC321B1TRF-E	B	26.5/113.3
D9	1720000791	S.VCP HVC321B1TRF-E	B	84.7/59.8
D10	1720000791	S.VCP HVC321B1TRF-E	B	86.4/51.2
D11	1790001621	S.DIO 1SV308 (TPL3,F)	B	63.5/103.1
D12	1790001621	S.DIO 1SV308 (TPL3,F)	B	62.4/101.1
D13	1720000791	S.VCP HVC321B1TRF-E	B	84.9/61.8
D14	1720000791	S.VCP HVC321B1TRF-E	B	84.4/72
D15	1720000791	S.VCP HVC321B1TRF-E	B	28.6/122.6
D16	1720000791	S.VCP HVC321B1TRF-E	B	26.5/114.6
D17	1720000641	S.VCP 1SV284 (TPH3,F)	B	83.5/63.5
D18	1720000471	S.VCP 1SV239 (TPH3,F)	B	96.3/66.7
D19	1750000520	S.DIO DAN222TL	T	59.6/39.8
D20	1790001260	S.DIO MA2S077-(TX)	T	39.5/57.9
D21	1750001610	S.VCP HVC365TRF-E	B	63/139.4
D22	1750001610	S.VCP HVC365TRF-E	B	59.8/136.7
D23	1750001610	S.VCP HVC365TRF-E	B	63/136.7
D24	1750001610	S.VCP HVC365TRF-E	B	59.8/139.4
D25	1750000370	S.DIO DA221 TL	B	46.5/142.5
D26	1790001250	S.DIO MA2S111-(TX)	B	48.3/142.5
D27	1790001250	S.DIO MA2S111-(TX)	B	58.3/142.5
D28	1750001610	S.VCP HVC365TRF-E [USA-01], [EXP-01]	B	37.6/138.4
D29	1750001610	S.VCP HVC365TRF-E [USA-01], [EXP-01]	B	37.6/135.7
D30	1720000471	S.VCP 1SV239 (TPH3,F)	B	95.6/56.8
D31	1750001610	S.VCP HVC365TRF-E	B	34.4/135.7
D32	1750001610	S.VCP HVC365TRF-E	B	34.4/138.4
D35	1750000351	S.DIO 1SV252 (TE85L,F)	B	143.7/92.9
D36	1750001080	S.DIO RB886G T2R	T	144.4/120.2
D37	1750001080	S.DIO RB886G T2R	T	145.6/120.2
D38	1750001360	S.DIO L709CER (9401)	B	84.7/134
D39	1750000581	S.DIO 1SV307 (TPH3,F)	B	36/144.8
D40	1750000370	S.DIO DA221 TL	T	114.3/77.8
D42	1720000641	S.VCP 1SV284 (TPH3,F)	B	26.5/112
D44	1710001061	DIO L407CDB		
D45	1790001211	S.DIO 1SS375-TL-E	B	83.8/128
D46	1750000520	S.DIO DAN222TL	T	13.3/131.1
D47	1750000520	S.DIO DAN222TL	T	13.2/129.1
D48	1790001211	S.DIO 1SS375-TL-E	B	119.6/144.5
D49	1790001211	S.DIO 1SS375-TL-E	B	139.5/133.2
D51	1790001250	S.DIO MA2S111-(TX)	T	10.5/127.1
D53	1790001810	S.VSR AVR-M1005C080MTABB	T	32.5/111.7
D55	1790001810	S.VSR AVR-M1005C080MTABB	T	30.5/11.7
D56	1790001810	S.VSR AVR-M1005C080MTABB	T	36.6/11.7
D59	1790000700	DIO DSA3A1		
D61	1750000520	S.DIO DAN222TL	T	118.4/14.7
D62	1750000431	S.DIO HSB88WSTR-E	B	68.3/123.3
D63	1790001250	S.DIO MA2S111-(TX)	B	34.2/20.8
D64	1750000370	S.DIO DA221 TL	T	63.2/93.9
D65	1750000370	S.DIO DA221 TL	T	65.2/93.9
D66	1750000370	S.DIO DA221 TL	T	67.2/93.9
D67	1750000370	S.DIO DA221 TL	T	61.9/105.9
D68	1750000370	S.DIO DA221 TL	T	59.9/105.5
D69	1750000370	S.DIO DA221 TL	T	69.2/93.9
D70	1750000370	S.DIO DA221 TL	T	71.2/93.9
D71	1750000370	S.DIO DA221 TL	T	69.1/109.5
D72	1750000370	S.DIO DA221 TL	T	71.2/109.5
D73	1750000370	S.DIO DA221 TL	T	73.3/109.5
D74	1750000370	S.DIO DA221 TL	T	75.3/109.5
D75	1790001250	S.DIO MA2S111-(TX)	B	41/38.6
D76	1790001250	S.DIO MA2S111-(TX)	B	26.4/41.3
D77	1790001250	S.DIO MA2S111-(TX)	B	49.2/29.9
D78	1730002360	S.ZEN MA8062-M (TX)	B	52.3/29.9
D79	1720000641	S.VCP 1SV284 (TPH3,F)	B	83.1/52
F11	2020001520	CER CFWLA450KFFA-B0		
F12	2020001460	CER CFWLA450KHFA-B0		
F13	2030000500	S.MLH FL-401 (46.35 MHz)	B	72/101
F14	2030000670	S.MLH FL-420 (46.35 MHz)	B	63.4/91.1
F15	2040001440	S.LC NFE31PT152Z1E9L	T	116.5/108.3
F16	2040001440	S.LC NFE31PT152Z1E9L	T	116.5/111.5
F17	2040001440	S.LC NFE31PT152Z1E9L	T	116.5/114.6
X1	6050012380	S.XTL CR-826 (15.3 MHz)	B	128.6/45.3
X2	6050012380	S.XTL CR-826 (15.3 MHz)	B	35.6/72.3
X3	6070000300	S.DCR JTBM450CX24 <JJE>	B	63.5/83.5
X4	6050012350	S.XTL CR-817 (12.288 MHz)	B	52.8/38.2
X5	6050012680	S.XTL CR-858 (SMD-49/18.432MHZ)	T	46.9/52.7
L1	6200004660	S.COL MLF1608A 1R8K-T	B	115.5/39.2
L2	6200004660	S.COL MLF1608A 1R8K-T	B	23.6/82.4
L3	6200004480	S.COL MLF1608D R82K-T	B	39.4/79.3
L4	6200003540	S.COL MLF1608D R22K-T	B	36.9/76.9

M.=Mounted side (T: Mounted on the Top side, B: Mounted on the Bottom side)
S.=Surface mount

[MAIN UNIT]

REF NO.	ORDER NO.	DESCRIPTION	M.	H/V LOCATION
L5	6200005691	S.COL ELJRE 18NGFA	B	102.7/45.6
L6	6200005691	S.COL ELJRE 18NGFA	B	47.3/101.1
L7	6200005661	S.COL ELJRE 10NGFA	B	44/99.1
L8	6200007120	S.COL ELJND 1R0J	B	27/124.1
L9	6200007120	S.COL ELJND 1R0J	B	27/120.8
L10	6200007120	S.COL ELJND 1R0J	B	25.9/116.8
L11	6200007120	S.COL ELJND 1R0J	B	82.5/61.4
L12	6200007120	S.COL ELJND 1R0J	B	83.1/49.9
L13	6200007120	S.COL ELJND 1R0J	B	28.7/111.6
L14	6200007120	S.COL ELJND 1R0J	B	85.3/66.4
L15	6200013220	S.COL C6342A-R13G-A	B	88.6/54.6
L16	6200010600	S.COL C6342A-67NG-A	B	33.8/122.7
L17	6200007120	S.COL ELJND 1R0J	B	28.7/116.8
L18	6200009910	S.COL C6342A-88NG-A	B	88.8/63.9
L19	6200007120	S.COL ELJND 1R0J	B	83.5/66.4
L20	6200007120	S.COL ELJND 1R0J	B	30.2/124.7
L21	6200009910	S.COL C6342A-88NG-A	B	33.1/114.4
L22	6200003550	S.COL MLF1608A 4R7K-T	B	73.4/109.9
L23	6200005011	S.COL NLV25T-100J	B	60.5/113.3
L24	6200010740	S.COL C2520C-R27G-A	B	70/109.1
L25	6200007120	S.COL ELJND 1R0J	B	97.4/62.5
L26	6200007120	S.COL ELJND 1R0J	B	98/56.1
L27	6130002961	S.COL #617DB-1327=P3	B	68.3/117
L28	6200007001	S.COL ELJRE 82NGFA	B	62.3/123.6
L29	6200006981	S.COL ELJRE R10GFA	B	102.6/58.6
L30	6200006981	S.COL ELJRE R10GFA	B	46.9/117.4
L31	6200002861	S.COL NLV25T-4R7J	T	91.2/20
L32	6130002961	S.COL #617DB-1327=P3	B	68.3/128.7
L33	6200005691	S.COL ELJRE 18NGFA	B	47.3/109.2
L34	6200005721	S.COL ELJRE 33NGFA	B	61.1/117.5
L35	6200005691	S.COL ELJRE 18NGFA	B	102.7/50.5
L36	6200007001	S.COL ELJRE 82NGFA	B	44.3/123.1
L37	6200005721	S.COL ELJRE 33NGFA	B	61.1/120.1
L38	6200007001	S.COL ELJRE 82NGFA	B	100/64.4
L39	6200010610	S.COL C6342A-50NG-A	B	67.4/138.5
L41	6200010610	S.COL C6342A-50NG-A	B	53.7/136.7
L42	6200006981	S.COL ELJRE R10GFA	B	134.5/84.5
L43	6200006671	S.COL ELJRE 68NGFA	B	138.9/90.1
L44	6200010610	S.COL C6342A-50NG-A	B	
L45	6200005741	S.COL ELJRE 47NGFA	B	41.9/137.3
L46	6200005741	S.COL ELJRE 47NGFA	B	142.8/87.4
L47	6200010610	S.COL C6342A-50NG-A	B	29.9/136.7
L48	6200007750	S.COL LQW2BHN56NJ03L	B	
L49	6200010000	S.COL C2012C-56NG-A	B	33.3/141.2
L50	6200007750	S.COL AS080547-47N	B	97.2/119.2
L51	6200007750	S.COL LQW2BHN56NJ03L	B	85.5/137.4
L52	6200010420	S.COL FHW1210HC 1R0JGT <JJE>	B	25.1/142.9
L53	6200010050	S.COL AS080547-47N	B	86.6/122.3
L55	6200010050	S.COL AS080547-47N	B	90.1/135.3
L56	6200010050	S.COL AS080547-47N	B	107.6/135
L57	6200010050	S.COL AS080547-47N	B	115.2/138.8
L58	6200010050	S.COL AS080547-47N	B	143.7/140.9
L59	6200002861	S.COL NLV25T-4R7J	T	55.4/37.5
L58	6200010420	S.COL FHW1210HC 1R0JGT <JJE>	B	147.1/146.2
L60	6200010420	S.COL FHW1210HC 1R0JGT <JJE>	B	24.5/147
L61	6200002961	S.COL NLV32T-4R7J	T	118.4/23.8
L62	6200013530	S.COL MLF2012E 100K-T	B	83.7/56.6
L63	6200010000	S.COL C2012C-56NG-A	B	72.3/137.8
L64	6200007120	S.COL ELJND 1R0J	B	81.8/54.9
L65	6200007120	S.COL ELJND 1R0J	B	41.7/120.7
L66	6200007120	S.COL ELJND 1R0J	B	42.4/115.2
L68	6200003960	S.COL MLF1608A 1R0K-T	B	140.7/94.7
L69	6200005661	S.COL ELJRE 10NGFA	B	102.7/42.3
R1	7030005310	S.RES ERJ2GEJ 124 X (120 k)	T	54.9/64.1
R2	7030005050	S.RES ERJ2GEJ 103 X (10 k)	T	58.7/61.7
R3	7030005240	S.RES ERJ2GEJ 473 X (47 k)	T	62.4/69.6
R4	7030007340	S.RES ERJ2GEJ 153 X (15 k)	B	57.3/80.1
R6	7030007300	S.RES ERJ2GEJ 332 X (3.3 k)	T	9.5/57.1
R7	7030010040	S.RES ERJ2GEJ-JPW	T	61.6/66.3
R8	7030005160	S.RES ERJ2GEJ 105 X (1 M)	T	24.9/70.4
R9	7030005160	S.RES ERJ2GEJ 105 X (1 M)	T	25.8/70.4
R10	7030005160	S.RES ERJ2GEJ 105 X (1 M)	T	26.7/70.4
R12	7510001730	S.TMR ERTJOEP 473J	B	129.1/49.3
R13	7030005090	S.RES ERJ2GEJ 104 X (100 k)	B	130.8/49.3
R15	7030007340	S.RES ERJ2GEJ 153 X (15 k)	B	54.5/78.3
R17	7030004980	S.RES ERJ2GEJ 101 X (100)	T	19.8/68.8
R18	7030007340	S.RES ERJ2GEJ 153 X (15 k)	B	55.3/79.2
R20	7030009150	S.RES ERJ2GEJ 824 X (820 k)	T	56.1/63.5
R22	7410001130	S.ARY EXB28V102JX	B	122.6/39
R23	7410001130	S.ARY EXB28V102JX	B	23.1/76.3
R24	7030005120	S.RES ERJ2GEJ 102 X (1 k)	B	115.5/42.2
R25	7030004970	S.RES ERJ2GEJ 470 X (47)	B	65.3/79.4
R26	7030010040	S.RES ERJ2GEJ-JPW	T	57.7/64.5
R27	7030005120	S.RES ERJ2GEJ 102 X (1 k)	T	57.8/51
R29	7030007570	S.RES ERJ2GEJ 122 X (1.2 k)	B	38.5/75.9
R30	7030007340	S.RES ERJ2GEJ 153 X (15 k)	B	52.8/81.1
R32	7030007340	S.RES ERJ2GEJ 153 X (15 k)	B	51.2/78.3
R33	7030007340	S.RES ERJ2GEJ 153 X (15 k)	B	48.4/78.2
R34	7030005240	S.RES ERJ2GEJ 473 X (47 k)	T	27.1/68.1
R35	7030005240	S.RES ERJ2GEJ 473 X (47 k)	T	28/68.1
R36	7030005240	S.RES ERJ2GEJ 473 X (47 k)	T	28.9/68.1
R38	7030005230	S.RES ERJ2GEJ 334 X (330 k)	T	27.6/70.4
R39	7030005230	S.RES ERJ2GEJ 334 X (330 k)	T	28.6/70.4
R40	7030005230	S.RES ERJ2GEJ 334 X (330 k)	T	29.5/70.4
R41	7030005110	S.RES ERJ2GEJ 224 X (220 k)	B	68.2/78.2
R42	7030006610	S.RES ERJ2GEJ 394 X (390 k)	B	34.4/75.5
R43	7030007290	S.RES ERJ2GEJ 222 X (2.2 k)	B	62.8/77.3
R44	7030005030	S.RES ERJ2GEJ 152 X (1.5 k)	B	71.4/78.2

[MAIN UNIT]

REF NO.	ORDER NO.	DESCRIPTION	M.	H/V LOCATION
R45	7030005040	S.RES ERJ2GEJ 472 X (4.7 k)	B	64.6/75.5
R46	7030005000	S.RES ERJ2GEJ 471 X (470)	T	52.7/57.1
R47	7030005720	S.RES ERJ2GEJ 563 X (56 k)	B	64.6/76.4
R48	7030005030	S.RES ERJ2GEJ 152 X (1.5 k)	B	62.8/76.4
R49	7030010040	S.RES ERJ2GEJ-JPW	T	55.6/57.3
R52	7030004980	S.RES ERJ2GEJ 101 X (100)	B	34.1/56.4
R53	7030005210	S.RES ERJ2GEJ 822 X (8.2 k)	B	16.8/57.6
R54	7030005000	S.RES ERJ2GEJ 471 X (470)	B	19.4/64.3
R56	7030004970	S.RES ERJ2GEJ 470 X (47)	B	121.9/50.4
R57	7030005040	S.RES ERJ2GEJ 472 X (4.7 k)	B	62.8/75.5
R58	7030008290	S.RES ERJ2GEJ 183 X (18 k)	B	56.5/49
R59	7030008290	S.RES ERJ2GEJ 183 X (18 k)	B	57.4/49
R60	7030005000	S.RES ERJ2GEJ 471 X (470)	B	32.3/74.3
R62	7030005120	S.RES ERJ2GEJ 102 X (1 k)	B	18.5/62.5
R63	7030005090	S.RES ERJ2GEJ 104 X (100 k)	T	55.6/60.5
R65	7030005000	S.RES ERJ2GEJ 471 X (470)	B	125.1/47.3
R66	7030004980	S.RES ERJ2GEJ 101 X (100)	B	56.5/50.6
R68	7030005040	S.RES ERJ2GEJ 472 X (4.7 k)	B	67.5/86.7
R69	7030005120	S.RES ERJ2GEJ 102 X (1 k)	B	32.7/83
R70	7030005050	S.RES ERJ2GEJ 103 X (10 k)	B	69.8/71.9
R71	7030005240	S.RES ERJ2GEJ 473 X (47 k)	B	31/62.6
R72	7030004980	S.RES ERJ2GEJ 101 X (100)	B	57.6/44.2
R73	7030010040	S.RES ERJ2GEJ-JPW	B	28.3/100.4
R74	7030005120	S.RES ERJ2GEJ 102 X (1 k)	B	25.8/83.5
R75	7030005110	S.RES ERJ2GEJ 224 X (220 k)	B	39.9/71.1
R76	7030010040	S.RES ERJ2GEJ-JPW	B	93.7/41.6
R77	7030005580	S.RES ERJ2GEJ 560 X (56)	B	119.7/48.8
R78	7030010040	S.RES ERJ2GEJ-JPW	B	29.9/99.3
R79	7030005580	S.RES ERJ2GEJ 560 X (56)	B	32.7/79.5
R80	7030004970	S.RES ERJ2GEJ 470 X (47)	B	23.5/41.1
R81	7030007250	S.RES ERJ2GEJ 220 X (22)	B	49.9/50.5
R82	7030008400	S.RES ERJ2GEJ 182 X (1.8 k)	B	56/44.2
R83	7030010040	S.RES ERJ2GEJ-JPW	B	32.4/106.5
R84	7030007290	S.RES ERJ2GEJ 222 X (2.2 k)	B	93.7/47.1
R85	7030007290	S.RES ERJ2GEJ 222 X (2.2 k)	B	37.8/107.1
R86	7030010040	S.RES ERJ2GEJ-JPW	B	33.2/105.2
R87	7030005090	S.RES ERJ2GEJ 104 X (100 k)	B	73.7/81.1
R88	7030005530	S.RES ERJ2GEJ 100 X (10)	B	39/71.1
R89	7030008400	S.RES ERJ2GEJ 182 X (1.8 k)	B	67.1/83.2
R90	7030008010	S.RES ERJ2GEJ 123 X (12 k)	T	54.5/73.3
R91	7030007290	S.RES ERJ2GEJ 222 X (2.2 k)	B	92.1/47.1
R92	7030009140	S.RES ERJ2GEJ 272 X (2.7 k)	B	92.1/41.6
R93	7030007290	S.RES ERJ2GEJ 222 X (2.2 k)	B	37.8/106.1
R94	7030009140	S.RES ERJ2GEJ 272 X (2.7 k)	B	28.3/98.3
R97	7410001170	S.ARY EXB28V470JX	B	42.9/49.9
R98	7030005530	S.RES ERJ2GEJ 100 X (10)	B	71/95.7
R99	7030005110	S.RES ERJ2GEJ 224 X (220 k)	B	71/92.9
R100	7030005600	S.RES ERJ2GEJ 273 X (27 k)	B	67.9/93.8
R101	7030004980	S.RES ERJ2GEJ 101 X (100)	B	92.1/42.6
R102	7030004980	S.RES ERJ2GEJ 101 X (100)	B	34.8/105.2
R103	7030004980	S.RES ERJ2GEJ 101 X (100)	B	28.3/101.3
R105	7030005050	S.RES ERJ2GEJ 103 X (10 k)	B	33.7/107.9
R107	7030004980	S.RES ERJ2GEJ 101 X (100)	B	87.1/47.1
R109	7030005090	S.RES ERJ2GEJ 104 X (100 k)	B	64.8/98.2
R111	7030005090	S.RES ERJ2GEJ 104 X (100 k)	B	37.8/104.4
R112	7030005070	S.RES ERJ2GEJ 683 X (68 k)	B	84.7/45.3
R113	7030005070	S.RES ERJ2GEJ 683 X (68 k)	B	32.4/106.2
R114	7030007300	S.RES ERJ2GEJ 332 X (3.3 k)	B	67.4/98.1
R115	7030007300	S.RES ERJ2GEJ 332 X (3.3 k)	B	67.9/91.3
R116	7030005050	S.RES ERJ2GEJ 103 X (10 k)	B	87.1/45.3
R117	7030005810	S.RES RR0510P-152-D (1.5 k)	B	81.1/46.2
R118	7030007280	S.RES ERJ2GEJ 331 X (330)	B	72.8/94.8
R119	7030007270	S.RES ERJ2GEJ 151 X (150)	B	68.1/89
R120	7030005810	S.RES RR0510P-152-D (1.5 k)	B	33.7/107
R121	7030008280	S.RES ERJ2GEJ 271 X (270)	B	27.3/108.7
R122	7030004970	S.RES ERJ2GEJ 470 X (47)	B	56.6/33.9
R123	7030004970	S.RES ERJ2GEJ 470 X (47)	B	49.5/38.5
R124	7030005240	S.RES ERJ2GEJ 473 X (47 k)	B	55.3/38.3
R125	7030008280	S.RES ERJ2GEJ 271 X (270)	B	84.7/46.2
R126	7030007290	S.RES ERJ2GEJ 222 X (2.2 k)	B	96.5/42.6
R127	7030005720	S.RES ERJ2GEJ 563 X (56 k)	T	88.4/58.4
R128	7030007290	S.RES ERJ2GEJ 222 X (2.2 k)	T	33.4/108.3
R129	7030005240	S.RES ERJ2GEJ 473 X (47 k)	B	55.3/35.1
R130	7030005240	S.RES ERJ2GEJ 473 X (47 k)	B	56.2/36.7
R131	7030004980	S.RES ERJ2GEJ 101 X (100)	B	54.2/32.4
R132	7030007290	S.RES ERJ2GEJ 222 X (2.2 k)	B	50.8/34.9
R133	7030007280	S.RES ERJ2GEJ 331 X (330)	B	67.5/104.4
R134	7030007270	S.RES ERJ2GEJ 151 X (150)	B	62.4/97.1
R136	7030005110	S.RES ERJ2GEJ 224 X (220 k)	B	81.8/65.5
R137	7030005110	S.RES ERJ2GEJ 224 X (220 k)	B	81.8/57
R138	7030005240	S.RES ERJ2GEJ 473 X (47 k)	T	95.3/65.8
R139	7030005060	S.RES ERJ2GEJ 333 X (33 k)	T	95.3/64.9
R140	7030007300	S.RES ERJ2GEJ 332 X (3.3 k)	B	63.9/100.3
R141	7030005060	S.RES ERJ2GEJ 333 X (33 k)	T	95.3/64
R142	7030007300	S.RES ERJ2GEJ 332 X (3.3 k)	B	65.4/102.5
R143	7030005240	S.RES ERJ2GEJ 473 X (47 k)	B	48.6/38.5
R144	7030005240	S.RES ERJ2GEJ 473 X (47 k)	B	48.6/36.8
R145	7030010040	S.RES ERJ2GEJ-JPW	B	47.3/37.3
R146	7030005060	S.RES ERJ2GEJ 333 X (33 k)	T	93.1/54.8
R148	7030004980	S.RES ERJ2GEJ 101 X (100)	B	

[MAIN UNIT]

REF NO.	ORDER NO.	DESCRIPTION	M.	H/V LOCATION
R165	7030010040	S.RES ERJ2GEJ-JPW	B	93/64.6
R166	7030010040	S.RES ERJ2GEJ-JPW	B	93.1/55
R167	7030005530	S.RES ERJ2GEJ 100 X (10)	B	62.5/112.2
R168	7030008340	S.RES RR0510P-182-D (1.8 k)	B	93/62.8
R169	7030008340	S.RES RR0510P-182-D (1.8 k)	B	93.1/53.2
R171	7030011920	S.RES RR0510P-561-D (560)	B	41.7/123.2
R172	7030009820	S.RES RR0510P-681-D (680)	B	97.4/65
R173	7030009820	S.RES RR0510P-681-D (680)	B	97.2/53.7
R174	7030009820	S.RES RR0510P-681-D (680)	B	42.1/113.8
R175	7030005530	S.RES ERJ2GEJ 100 X (10)	B	73.6/111
R176	7030005090	S.RES ERJ2GEJ 104 X (100 k)	B	100.6/56.8
R177	7030005090	S.RES ERJ2GEJ 104 X (100 k)	B	44.9/115.6
R178	7030004980	S.RES ERJ2GEJ 101 X (100)	B	100.6/55.9
R179	7030004980	S.RES ERJ2GEJ 101 X (100)	B	44.9/114.7
R180	7030005050	S.RES ERJ2GEJ 103 X (10 k)	T	37/108.3
R181	7030005050	S.RES ERJ2GEJ 103 X (10 k)	B	96.4/49
R182	7030007300	S.RES ERJ2GEJ 332 X (3.3 k)		
		[USA-01], [EXP-01]	B	68.5/107
R184	7030008280	S.RES ERJ2GEJ 271 X (270)	B	63.2/119.1
R185	7030010090	S.RES ERJ2GEJ 180 X (18)	B	62.3/117.5
R186	7030005120	S.RES ERJ2GEJ 102 X (1 k)	T	39.2/50.7
R187	7030008010	S.RES ERJ2GEJ 123 X (12 k)	T	41.5/55.9
R188	7410001150	S.ARY EXB28V471JX	T	48.5/41.1
R189	7030005090	S.RES ERJ2GEJ 104 X (100 k)	T	55.6/39.5
R190	7030008010	S.RES ERJ2GEJ 123 X (12 k)	T	43.1/55.9
R191	7030005000	S.RES ERJ2GEJ 471 X (470)	B	43.5/112.2
R192	7030005110	S.RES ERJ2GEJ 224 X (220 k)	B	44.4/112.2
R193	7030008280	S.RES ERJ2GEJ 271 X (270)	B	59.6/116.8
R194	7030004980	S.RES ERJ2GEJ 101 X (100)	B	99.2/53
R195	7030005110	S.RES ERJ2GEJ 224 X (220 k)	B	100.1/53
R196	7030009320	S.RES ERJ2GEJ 4R7 X (4.7)	B	48/120.7
R197	7030005050	S.RES ERJ2GEJ 103 X (10 k)	T	40.5/50.6
R198	7030009320	S.RES ERJ2GEJ 4R7 X (4.7)	B	103.7/62
R199	7030005050	S.RES ERJ2GEJ 103 X (10 k)	T	67.6/57.5
R200	7030004980	S.RES ERJ2GEJ 101 X (100)	B	43.1/123.1
R201	7030005090	S.RES ERJ2GEJ 104 X (100 k)	B	48/122.6
R202	7030005160	S.RES ERJ2GEJ 105 X (1 M)	T	41.4/48.6
R204	7030005050	S.RES ERJ2GEJ 103 X (10 k)	T	54.7/39.5
R205	7030008010	S.RES ERJ2GEJ 123 X (12 k)	T	36.5/57.9
R207	7030005090	S.RES ERJ2GEJ 104 X (100 k)	B	103.7/64
R208	7030010040	S.RES ERJ2GEJ-JPW	B	46.2/120.7
R209	7030005000	S.RES ERJ2GEJ 471 X (470)	T	67.6/56.5
R212	7410001140	S.ARY EXB28V104JX	T	52.3/41.1
R213	7030005530	S.RES ERJ2GEJ 100 X (10)	T	41.4/47.7
R214	7030004980	S.RES ERJ2GEJ 101 X (100)	B	98.9/64
R215	7030010040	S.RES ERJ2GEJ-JPW	B	100.9/62
R216	7410001140	S.ARY EXB28V104JX	T	17.3/52.4
R217	7410001140	S.ARY EXB28V104JX	T	38.6/56
R218	7030005090	S.RES ERJ2GEJ 104 X (100 k)	B	61.4/138.5
R220	7410001140	S.ARY EXB28V104JX	T	15.2/50.7
R222	7410001140	S.ARY EXB28V104JX	T	36.1/56
R223	7030005050	S.RES ERJ2GEJ 103 X (10 k)	B	61.4/137.6
R224	7410001150	S.ARY EXB28V471JX	T	30.4/53.1
R225	7030005090	S.RES ERJ2GEJ 104 X (100 k)	B	61.4/139.4
R226	7030005110	S.RES ERJ2GEJ 224 X (220 k)	B	39.9/72.7
R227	7410001150	S.ARY EXB28V471JX	T	42.9/28.9
R230	7410001150	S.ARY EXB28V471JX	T	28.6/50.9
R231	7030005000	S.RES ERJ2GEJ 471 X (470)		
		[USA-01], [EXP-01]	B	58.2/139.4
		[EUR-01]	B	58.2/139.4
R232	7030009280	S.RES ERJ2GEJ 391 X	T	25.9/49.4
R233	7030004980	S.RES ERJ2GEJ 101 X (100)	B	58.2/135.8
R234	7410001150	S.ARY EXB28V471JX	T	42.5/25.7
R235	7410001150	S.ARY EXB28V471JX	T	24.2/47.6
R236	7030005090	S.RES ERJ2GEJ 104 X (100 k)	B	132.4/82.7
R237	7030005530	S.RES ERJ2GEJ 100 X (10)	B	49.4/138.8
R238	7410001150	S.ARY EXB28V471JX	T	45.7/28.9
R239	7410001150	S.ARY EXB28V471JX	T	22.4/45.8
R240	7030004980	S.RES ERJ2GEJ 101 X (100)	B	134.7/86.7
R241	7030004990	S.RES ERJ2GEJ 221 X (220)	B	49.4/134.3
R242	7030009320	S.RES ERJ2GEJ 4R7 X (4.7)	B	48.4/138.8
R243	7030005090	S.RES ERJ2GEJ 104 X (100 k)	B	47.4/138.8
R244	7410001150	S.ARY EXB28V471JX	T	39.7/25.8
R245	7410001150	S.ARY EXB28V471JX	T	20.2/42.4
R246	7030005310	S.RES ERJ2GEJ 124 X (120 k)	B	45.6/136.6
R247	7030005720	S.RES ERJ2GEJ 563 X (56 k)	B	48.4/140.4
R249	7030008010	S.RES ERJ2GEJ 123 X (12 k)	B	135.6/88.4
R250	7030004980	S.RES ERJ2GEJ 101 X (100)	B	133.8/90.1
R251	7030006610	S.RES ERJ2GEJ 394 X (390 k)	B	49.4/142.5
R252	7030010040	S.RES ERJ2GEJ-JPW	B	132/86.7
R253	7030004970	S.RES ERJ2GEJ 470 X (47)	B	136.5/90.1
R255	7030005040	S.RES ERJ2GEJ 472 X (4.7 k)	B	52.4/142.5
R256	7030005040	S.RES ERJ2GEJ 472 X (4.7 k)	B	137.7/90.1
R257	7410001140	S.ARY EXB28V104JX	T	14.5/45.7
R259	7030005170	S.RES ERJ2GEJ 474 X (470 k)	B	57.1/142.5
R260	7030007290	S.RES ERJ2GEJ 222 X (2.2 k)	B	108.8/25.3
R261	7030005050	S.RES ERJ2GEJ 103 X (10 k)	T	52.5/25.7
R262	7030005090	S.RES ERJ2GEJ 104 X (100 k)	T	51.9/22.8
R263	7410001140	S.ARY EXB28V104JX	T	46.2/20
R264	7410001140	S.ARY EXB28V104JX	T	50.2/24
R265	7030010040	S.RES ERJ2GEJ-JPW	B	87.1/43.5
R266	7030005090	S.RES ERJ2GEJ 104 X (100 k)		
		[USA-01], [EXP-01] only	B	36/138.4
R267	7410001140	S.ARY EXB28V104JX	T	15/42.5
R268	7410001150	S.ARY EXB28V471JX	T	45.7/31.8
R269	7030004980	S.RES ERJ2GEJ 101 X (100)	B	143.2/94.7
R270	7030005050	S.RES ERJ2GEJ 103 X (10 k)	B	36/136.6
R271	7030005090	S.RES ERJ2GEJ 104 X (100 k)	T	23.8/26.7
R272	7410001150	S.ARY EXB28V104JX	T	17.9/32.3
R273	7410001150	S.ARY EXB28V104JX	T	17.9/35.1
R274	7030005090	S.RES ERJ2GEJ 104 X (100 k)	B	36/137.5
R275	7030005060	S.RES ERJ2GEJ 333 X (33 k)	T	93.1/55.7
R276	7030010040	S.RES ERJ2GEJ-JPW	B	87.1/44.4
R277	7030004980	S.RES ERJ2GEJ 101 X (100)	T	145/126

[MAIN UNIT]

REF NO.	ORDER NO.	DESCRIPTION	M.	H/V LOCATION
R278	7030005090	S.RES ERJ2GEJ 104 X (100 k)	T	13.9/65.6
R279	7030007290	S.RES ERJ2GEJ 222 X (2.2 k)	T	102.4/90.1
R280	7030004990	S.RES ERJ2GEJ 221 X (220)	T	141.3/127.7
R281	7410001150	S.ARY EXB28V471JX	T	21.3/31.8
R282	7030005090	S.RES ERJ2GEJ 104 X (100 k)	T	37.8/20.3
R283	7030005100	S.RES ERJ2GEJ 154 X (150 k)	T	144/124.4
R285	7030005050	S.RES ERJ2GEJ 103 X (10 k)	T	101.6/79.5
R286	7030005080	S.RES ERJ2GEJ 823 X (82 k)	B	40.8/72.7
R287	7410001140	S.ARY EXB28V104JX	T	49.7/27.7
R288	7030007340	S.RES ERJ2GEJ 153 X (15 k)	T	139.5/122.5
R289	7030006070	S.RES ERJ12YJ101U (100)	B	86.9/117.5
R290	7030005050	S.RES ERJ2GEJ 103 X (10 k)	T	138.6/122.5
R291	7030005040	S.RES ERJ2GEJ 472 X (4.7 k)	T	137.6/127.7
R292	7030005050	S.RES ERJ2GEJ 103 X (10 k)	T	144/126
R293	7030004980	S.RES ERJ2GEJ 101 X (100)	B	136.5/83.3
R294	7030004980	S.RES ERJ2GEJ 101 X (100)	B	136.5/85
R295	7030005090	S.RES ERJ2GEJ 104 X (100 k)	T	137.6/122.5
R296	7030000440	S.RES MCR10EZHJ 3.3 k	T	118.4/79.6
R297	7030000440	S.RES MCR10EZHJ 3.3 k	T	120.2/79.6
R298	7030000440	S.RES MCR10EZHJ 3.3 k	T	116.6/79.6
R299	7030004980	S.RES ERJ2GEJ 101 X (100)	B	29.1/19.4
R300	7030005530	S.RES ERJ2GEJ 100 X (10)	T	47.6/73.1
R301	7030008300	S.RES ERJ2GEJ 184 X (180 k)	B	85.6/105.6
R302	7030005590	S.RES ERJ2GEJ 680 X (68)	B	135.6/85
R303	7410001150	S.ARY EXB28V471JX	T	47.7/68.4
R304	7030005050	S.RES ERJ2GEJ 103 X (10 k)	B	84.3/130
R306	7520000260	S.POS PRF18BB471QB1RB	B	84.4/104.4
R308	7030005060	S.RES ERJ2GEJ 333 X (33 k)		
		[USA-01], [EXP-01]	T	144/127.7
		[EUR-01]	T	144/127.7
R309	7030005040	S.RES ERJ2GEJ 472 X (4.7 k)	T	102.2/75.7
R310	7030005030	S.RES ERJ2GEJ 152 X (1.5 k)	T	143.3/120.2
R311	7030008410	S.RES ERJ2GEJ 392 X (3.9 k)	T	145/122.5
R312	7030005050	S.RES ERJ2GEJ 103 X (10 k)	T	146.8/120.2
R313	7030005050	S.RES ERJ2GEJ 103 X (10 k)	T	103.5/77.8
R314	7030007280	S.RES ERJ2GEJ 331 X (330)	T	146/124.4
R315	7030005700	S.RES ERJ2GEJ 274 X (270 k)	B	86/128.9
R316	7030005050	S.RES ERJ2GEJ 103 X (10 k)	T	11.2/128.2
R317	7030005010	S.RES ERJ2GEJ 681 X (680)	B	138.5/94.7
R318	7030003260	S.RES ERJ3GEYJ 330 V (33)	B	140.2/90.1
R320	7030005090	S.RES ERJ2GEJ 104 X (100 k)	T	15/124.1
R321	7030003370	S.RES ERJ3GEYJ 271 V (270)	B	119.6/141.7
R322	7030005600	S.RES ERJ2GEJ 273 X (27 k)	B	121.5/143.4
R324	7030005050	S.RES ERJ2GEJ 103 X (10 k)	B	31.3/12
R325	7030005120	S.RES ERJ2GEJ 102 X (1 k)	B	32.3/12
R326	7030005240	S.RES ERJ2GEJ 473 X (47 k)	T	13.2/125.7
R327	7030000260	S.RES MCR10EZHJ 100 (101)	B	119.7/132.8
R328	7030000280	S.RES MCR10EZHJ 150 (151)	B	139.3/144.3
R331	7030004980	S.RES ERJ2GEJ 101 X (100)	T	12/120
R332	7030003370	S.RES ERJ3GEYJ 271 V (270)	B	139.5/136
R333	7030005600	S.RES ERJ2GEJ 273 X (27 k)	B	137.7/131.9
R334	7030005651	S.RES ERA3YKD 304V (300 k)	T	57.8/30.5
R335	7030005871	S.RES ERA3YKD 104V (100 k)	T	55.9/29.7
R336	7030005110	S.RES ERJ2GEJ 224 X (220 k)	T	12/120.9
R337	7030005110	S.RES ERJ2GEJ 224 X (220 k)	T	13.2/120.6
R339	7030005090	S.RES ERJ2GEJ 104 X (100 k)	T	12/125.3
R341	7030005050	S.RES ERJ2GEJ 103 X (10 k)	B	33.3/12
R342	7030005090	S.RES ERJ2GEJ 104 X (100 k)	B	45.3/56.9
R346	7410001150	S.ARY EXB28V471JX	T	43.5/73.8
R347	7030005000	S.RES ERJ2GEJ 471 X (470)	T	9.8/132.9
R348	7030000620	S.RES MCR10EZHJ 100 k	B	147.2/150.9
R349	7030000620	S.RES MCR10EZHJ 100 k	B	26/149.7
R350	7030003350	S.RES ERJ3GEYJ 103 V (10 k)	B	6.4/131
R352	7030005040	S.RES ERJ2GEJ 472 X (4.7 k)	T	10.2/125.3
R353	7030005240	S.RES ERJ2GEJ 473 X (47 k)	B	55.8/56.9
R354	7030005700	S.RES ERJ2GEJ 274 X (270 k)	T	123.3/103
R355	7030005090	S.RES ERJ2GEJ 104 X (100 k)	T	127.4/102.2
R356	7030005050	S.RES ERJ2GEJ 103 X (10 k)	B	9.8/134.5
R357	7030003350	S.RES ERJ3GEYJ 103 V (10 k)	B	10.1/150.2
R362	7540000290	ABS ERZV10D220		
R364	7030005110	S.RES ERJ2GEJ 224 X (220 k)	T	65.1/71.2
R365	7030005050	S.RES ERJ2GEJ 103 X (10 k)	T	7.4/120.7
R366	7030007290	S.RES ERJ2GEJ 222 X (2.2 k)	T	7/123.5
R367	7030004980	S.RES ERJ2GEJ 101 X (100)	T	9.7/117.3
R368	7030008300	S.RES ERJ2GEJ 184 X (180 k)	T	8.5/117.8
R369	7030005230	S.RES ERJ2GEJ 334 X (330 k)	T	9.7/118.2
R370	7030008280	S.RES ERJ2GEJ 271 X (270)	T	6.1/120.7
R371	7030010040	S.RES ERJ2GEJ-JPW	T	5/117.3
R372	7030005000	S.RES ERJ2GEJ 471 X (470)	T	115.3/15.8
R373	7030005050	S.RES ERJ2GEJ 103 X (10 k)	T	115.3/14
R374	7030000140	S.RES MCR10EZHJ 10 (100)	T	111.2/12.3

[MAIN UNIT]

REF NO.	ORDER NO.	DESCRIPTION	M.	H/V LOCATION
R445	7030005240	S.RES ERJ2GEJ 473 X (47 k)	B	13.5/36.1
R446	7030005240	S.RES ERJ2GEJ 473 X (47 k)	B	13.5/37.4
R447	7030005090	S.RES ERJ2GEJ 104 X (100 k)	T	50.2/19.2
R448	7030005090	S.RES ERJ2GEJ 104 X (100 k)	T	49.3/19.2
R449	7030005170	S.RES ERJ2GEJ 474 X (470 k)	T	39.5/19.2
R450	7030005050	S.RES ERJ2GEJ 103 X (10 k)	T	50.2/16.5
R453	7030005120	S.RES ERJ2GEJ 102 X (1 k)	T	52.1/14.9
R454	7030005120	S.RES ERJ2GEJ 102 X (1 k)	B	94.9/2.7
R455	7030005010	S.RES ERJ2GEJ 681 X (680)	B	124.9/2.7
R456	7030005120	S.RES ERJ2GEJ 102 X (1 k)	B	109.9/2.7
R467	7030005240	S.RES ERJ2GEJ 473 X (47 k)	B	38/44.6
R468	7410001140	S.ARY EXB28V104JX	B	31.8/48.5
R469	7030005090	S.RES ERJ2GEJ 104 X (100 k)	B	32.6/44.6
R470	7030005090	S.RES ERJ2GEJ 104 X (100 k)	T	10.9/20.2
R471	7030005090	S.RES ERJ2GEJ 104 X (100 k)	B	47.7/44.2
R472	7030005240	S.RES ERJ2GEJ 473 X (47 k)	B	4.8/36.1
R473	7030005090	S.RES ERJ2GEJ 104 X (100 k)	B	46.2/44.6
R474	7030005530	S.RES ERJ2GEJ 100 X (10)	B	15.5/55.3
R475	7030005000	S.RES ERJ2GEJ 471 X (470)	B	9/56.2
R476	7030005090	S.RES ERJ2GEJ 104 X (100 k)	B	15/53.5
R477	7030005080	S.RES ERJ2GEJ 823 X (82 k)	B	15/52.6
R478	7030005050	S.RES ERJ2GEJ 103 X (10 k)	B	9.1/54.7
R479	7030005110	S.RES ERJ2GEJ 224 X (220 k)	T	64.2/69.6
R480	7030005050	S.RES ERJ2GEJ 103 X (10 k)	B	15.6/61.5
R481	7030005050	S.RES ERJ2GEJ 103 X (10 k)	B	16.5/59.9
R482	7410001150	S.ARY EXB28V471JX	T	19.6/45.1
R483	7030005090	S.RES ERJ2GEJ 104 X (100 k)	B	31.2/56.5
R484	7030005090	S.RES ERJ2GEJ 104 X (100 k)	B	28.8/50.9
R485	7410001150	S.ARY EXB28V471JX	T	67.3/96.9
R486	7410001150	S.ARY EXB28V471JX	T	63.9/107
R487	7410001150	S.ARY EXB28V471JX	T	73/106.9
R488	7030005000	S.RES ERJ2GEJ 471 X (470)	B	9.5/54.9
R489	7030004980	S.RES ERJ2GEJ 101 X (100)	B	24.1/58.7
R490	7030008290	S.RES ERJ2GEJ 183 X (18 k)	B	28.2/58.4
R491	7030004980	S.RES ERJ2GEJ 101 X (100)	B	26.1/51.2
R492	7030005240	S.RES ERJ2GEJ 473 X (47 k)	B	29.8/58.8
R493	7030010040	S.RES ERJ2GEJ-JPW	T	11.3/19
R494	7030005000	S.RES ERJ2GEJ 471 X (470)	T	73.3/99
R495	7030008270	S.RES RR0510P-104-D (100 k)	T	54.9/55.3
R496	7030006020	S.RES RR0510P-682-D (6.8 k)	T	52.7/56.2
R497	7030008250	S.RES RR0510P-562-D (5.6 k)	T	52.7/55.3
R498	7030005600	S.RES ERJ2GEJ 273 X (27 k)	B	61.4/103.1
R499	7030004980	S.RES ERJ2GEJ 101 X (100)	T	24.4/57
R500	7030005600	S.RES ERJ2GEJ 273 X (27 k)	T	21.2/57.5
R501	7030005220	S.RES ERJ2GEJ 223 X (22 k)	T	22.8/53.8
R502	7030005090	S.RES ERJ2GEJ 104 X (100 k)	T	28/55
R503	7030007350	S.RES ERJ2GEJ 393 X (39 k)	T	55.6/58.9
R504	7030011920	S.RES RR0510P-561-D (560)	T	52.7/54.4
R505	7030010040	S.RES ERJ2GEJ-JPW	T	113.4/18.3
R506	7030005110	S.RES ERJ2GEJ 224 X (220 k)	T	113.4/19.3
R507	7030005090	S.RES ERJ2GEJ 104 X (100 k)	B	93.7/42.6
R508	7030010040	S.RES ERJ2GEJ-JPW	B	33.3/15.2
R509	7030005050	S.RES ERJ2GEJ 103 X (10 k)	B	29/14.1
R510	7030007350	S.RES ERJ2GEJ 393 X (39 k)	B	29.1/18.5
R511	7030005050	S.RES ERJ2GEJ 103 X (10 k)	B	30.8/18.5
R512	7030005050	S.RES ERJ2GEJ 103 X (10 k)	B	72.6/91
R513	7030007280	S.RES ERJ2GEJ 331 X (330)	B	62.5/66.3
R530	7030005240	S.RES ERJ2GEJ 473 X (47 k)	B	45.1/37.1
R532	7030005000	S.RES ERJ2GEJ 471 X (470)	T	57.2/18.4
R533	7030005090	S.RES ERJ2GEJ 104 X (100 k)	B	45.3/58.6
R534	7030005600	S.RES ERJ2GEJ 273 X (27 k)	B	56.7/56.9
R535	7030004980	S.RES ERJ2GEJ 101 X (100)	B	55.8/58.6
R536	7030005600	S.RES ERJ2GEJ 273 X (27 k)	B	41.6/41.2
R537	7030010040	S.RES ERJ2GEJ-JPW	T	64.2/71.2
R539	7030005110	S.RES ERJ2GEJ 224 X (220 k)	T	90.6/17.9
R540	7030005090	S.RES ERJ2GEJ 104 X (100 k)	T	28.9/55
R541	7030005220	S.RES ERJ2GEJ 223 X (22 k)	T	70.4/65.1
R542	7030005120	S.RES ERJ2GEJ 102 X (1 k)	T	61.2/98.7
R545	7030010040	S.RES ERJ2GEJ-JPW	T	61.2/99.6
R546	7030010040	S.RES ERJ2GEJ-JPW	T	69.7/99.1
R547	7030010040	S.RES ERJ2GEJ-JPW	T	48.7/149.0
R548	7030009140	S.RES ERJ2GEJ 272 X (2.7 k)	T	
C1	4030017420	S.CER ECJ0EC1H470J	B	120.7/39
C2	4030017420	S.CER ECJ0EC1H470J	B	22.9/78.1
C3	4030016930	S.CER ECJ0EB1A104K	B	130.8/50.2
C4	4030017420	S.CER ECJ0EC1H470J	B	121.9/37.1
C5	4030017420	S.CER ECJ0EC1H470J	B	21.7/77.1
C6	4030016930	S.CER ECJ0EB1A104K	B	52.4/77.9
C7	4030017420	S.CER ECJ0EC1H470J	B	122.8/37.1
C8	4030017420	S.CER ECJ0EC1H470J	B	21.7/75.5
C9	4030017460	S.CER ECJ0EB1E102K	T	17.6/59
C10	4030016930	S.CER ECJ0EB1A104K	B	55.7/77.9
C11	4030016930	S.CER ECJ0EB1A104K	B	123.7/37.1
C12	4030016930	S.CER ECJ0EB1A104K	B	22.1/74.3
C13	4030016930	S.CER ECJ0EB1A104K	B	55.6/80.7
C14	4030017460	S.CER ECJ0EB1E102K	B	16.1/59.9
C15	4030016930	S.CER ECJ0EB1A104K	T	62.4/67.5
C16	4030017620	S.CER ECJ0EC1H100C	T	56.1/64.5
C17	4030016930	S.CER ECJ0EB1A104K	B	115.5/40.6
C18	4030017430	S.CER ECJ0EC1H101J	T	62.4/71.2
C19	4030016930	S.CER ECJ0EB1A104K	B	22.9/80.3
C20	4550006250	S.TAN TEESVA 1A 106M8R	B	115.3/37.5
C21	4550006250	S.TAN TEESVA 1A 106M8R	B	21.3/80.5
C22	4030016930	S.CER ECJ0EB1A104K	B	50/77.9
C23	4030016930	S.CER ECJ0EB1A104K	T	57.8/52.6
C24	4030016930	S.CER ECJ0EB1A104K	B	50.3/81.1
C25	4030016930	S.CER ECJ0EB1A104K	B	54.4/81.1
C26	4030017460	S.CER ECJ0EB1E102K	B	117.8/39.2
C27	4030017460	S.CER ECJ0EB1E102K	B	23.8/80.3
C28	4030016930	S.CER ECJ0EB1A104K	B	53.3/77.9
C30	4030017460	S.CER ECJ0EB1E102K	T	59.8/67
C31	4030016930	S.CER ECJ0EB1A104K	T	60.5/53
C32	4030017590	S.CER ECJ0EC1H070C	B	38.4/79.1

[MAIN UNIT]

REF NO.	ORDER NO.	DESCRIPTION	M.	H/V LOCATION
C33	4030016930	S.CER ECJ0EB1A104K	T	58.9/67
C34	4030017570	S.CER ECJ0EC1H040K	B	37.2/78.7
C35	4030016930	S.CER ECJ0EB1A104K	B	35.8/75.7
C36	4030017500	S.CER ECJ0EC1H560J	B	37.2/79.6
C37	4030016930	S.CER ECJ0EB1A104K	B	48.4/79.8
C38	4030016930	S.CER ECJ0EB1A104K	B	69.8/78.2
C39	4030017360	S.CER ECJ0EC1H030B	B	71.4/77.3
C40	4030017690	S.CER ECJ0EC1H121J	B	68.2/76.4
C41	4030018860	S.CER ECJ0EB0J105K	B	31/58.2
C42	4030017690	S.CER ECJ0EC1H121J	B	66.4/78.2
C43	4030016930	S.CER ECJ0EB1A104K	B	55.6/49
C44	4030018860	S.CER ECJ0EB0J105K	B	35.7/56.4
C45	4030016950	S.CER ECJ0EB1A473K	B	34.5/55.2
C47	4030017460	S.CER ECJ0EB1E102K	B	64.6/77.3
C48	4030016930	S.CER ECJ0EB1A104K	T	54.3/54.4
C49	4030018860	S.CER ECJ0EB0J105K	B	15.6/58.3
C50	4030016930	S.CER ECJ0EB1A104K	B	130.8/48.4
C51	4030017620	S.CER ECJ0EC1H100C	B	125.1/45.6
C52	4030017420	S.CER ECJ0EC1H470J	B	120.6/48.8
C53	4030017420	S.CER ECJ0EC1H470J	B	32.7/78.4
C54	4030017660	S.CER ECJ0EC1H330J	B	32.7/77.3
C56	4030016950	S.CER ECJ0EB1A473K	B	31.9/59.1
C59	4030017430	S.CER ECJ0EC1H101J	B	32.7/75.5
C60	4030017620	S.CER ECJ0EC1H100C	B	32.3/72.7
C61	4030018900	S.CER ECJ0EB0J474K	B	18/63.8
C62	4030016930	S.CER ECJ0EB1A104K	B	33.6/55.2
C63	4030016930	S.CER ECJ0EB1A104K	T	55.6/62.1
C64	4030017460	S.CER ECJ0EB1E102K	B	33.2/104.3
C66	4030017430	S.CER ECJ0EC1H101J	B	123.5/48.4
C67	4030017460	S.CER ECJ0EB1E102K	B	67.5/87.7
C69	4030016930	S.CER ECJ0EB1A104K	B	29.8/63
C70	4030017460	S.CER ECJ0EB1E102K	B	64.3/79.4
C71	4030016930	S.CER ECJ0EB1A104K	B	57.6/43.3
C72	4030018910	S.CER C1608 JB 0J 475K-T	B	29.3/61.9
C73	4030017460	S.CER ECJ0EB1E102K	B	93.7/46.2
C74	4030017780	S.CER ECJ0EB1E472K	B	93.7/40.7
C75	4030017460	S.CER ECJ0EB1E102K	B	39.6/106.1
C76	4030017780	S.CER ECJ0EB1E472K	B	29.9/98.3
C77	4030016930	S.CER ECJ0EB1A104K	T	53.9/57.7
C78	4030017460	S.CER ECJ0EB1E102K	B	118.7/48.8
C79	4030017460	S.CER ECJ0EB1E102K	B	34.3/79.5
C80	4030017380	S.CER ECJ0EC1H050B	B	102.4/44.5
C81	4030017380	S.CER ECJ0EC1H050B	B	44/101.1
C82	4550006250	S.TAN TEESVA 1A 106M8R	B	61.1/79.2
C83	4030017460	S.CER ECJ0EB1E102K	B	71.7/86.7
C84	4030017420	S.CER ECJ0EC1H470J	B	74.7/81.1
C85	4030017590	S.CER ECJ0EC1H070C	B	56/43.3
C86	4030016930	S.CER ECJ0EB1A104K	B	51.7/47.1
C87	4030018910	S.CER C1608 JB 0J 475K-T	B	54.3/48.4
C88	4030017780	S.CER ECJ0EB1E472K	B	92.1/40.7
C89	4030017780	S.CER ECJ0EB1E472K	B	28.3/99.3
C90	4030017680	S.CER ECJ0EC1H820J	B	69.1/86.7
C91	4030016930	S.CER ECJ0EB1A104K	T	60.7/66.3
C92	4030016930	S.CER ECJ0EB1C103K	B	72.7/88
C93	4030017460	S.CER ECJ0EB1E102K	B	70.5/87.2
C94	4030017350	S.CER ECJ0EC1H020B	B	103.2/47.6
C96	4030018910	S.CER C1608 JB 0J 475K-T	B	49.2/48.9
C97	4030016930	S.CER ECJ0EB1A104K	B	57.4/50.6
C98	4030017460	S.CER ECJ0EB1E102K	B	36.4/105.2
C99	4030017460	S.CER ECJ0EB1E102K	B	40.8/71.1
C100	4030017460	S.CER ECJ0EB1E102K	B	84.7/48
C101	4030017620	S.CER ECJ0EC1H100C	B	37.7/63.2
C102	4550007650	S.TAN F931V105MAABMA	B	88.7/41
C103	4550007650	S.TAN F931V105MAABMA	B	26.2/100.3
C104	4030016930	S.CER ECJ0EB1A104K	B	39.9/74.3
C105	4030017580	S.CER ECJ0EC1H060C	B	103.2/46.7
C106	4030017350	S.CER ECJ0EC1H020B	B	47/102.2
C107	4030017590	S.CER ECJ0EC1H070C	B	72.3/90
C108	4030017460	S.CER ECJ0EB1E102K	B	87.1/48
C109	4030017380	S.CER ECJ0EC1H050B	B	101.9/47.2
C110	4030017360	S.CER ECJ0EC1H030B	B	46.5/103.5
C111	4030016930	S.CER ECJ0EB1C103K	B	71/93.8
C112	4550007650	S.TAN F931V105MAABMA	B	83.6/41
C113	4550007650	S.TAN F931V105MAABMA	B	28.3/105.6
C114	4030017580	S.CER ECJ0EC1H060C	B	103.2/48.5
C115	4030017350	S.CER ECJ0EC1H020B	B	47/104.9
C116	4030017460	S.CER ECJ0EB1E102K	B	71/91
C117	4030016930	S.CER ECJ0EB1C103K	B	73.5/95.7
C118	4030016930	S.CER ECJ0EB1C103K	B	71/92
C119	4030017350	S.CER ECJ0EC1H020B	B	103.2/49.4
C121	4030016930	S.CER ECJ0EB1C103K	B	71/94.8
C122	4030016930	S.CER ECJ0EB1C103K	B	69.1/90.1
C123	4030016930	S.CER ECJ0EB1A104K	B	67.4/98.3
C124	4030016930	S.CER ECJ0EB1A104K	B	48.5/50.5
C125	4030016930	S.CER ECJ0EB1C103K	B	98.1/42.6
C126	4030016930	S.CER ECJ0EB1C103K	B	

[MAIN UNIT]

REF NO.	ORDER NO.	DESCRIPTION	M.	H/V LOCATION
C153	4030017380	S.CER ECJ0EC1H050B	B	49.8/34.9
C154	4030017420	S.CER ECJ0EC1H470J	B	25.6/124.3
C155	4030017460	S.CER ECJ0EB1E102K	B	25.6/119.8
C156	4030017420	S.CER ECJ0EC1H470J	B	27.3/117.4
C157	4030017460	S.CER ECJ0EB1E102K	B	30.8/111.5
C158	4030017420	S.CER ECJ0EC1H470J	B	81.8/59.8
C159	4030017420	S.CER ECJ0EC1H470J	B	82.3/47.6
C160	4030016790	S.CER ECJ0EB1C103K	B	65.7/104.4
C161	4030016790	S.CER ECJ0EB1C103K	B	62.4/98.9
C162	4030018860	S.CER ECJ0EB0J105K	T	95.3/66.7
C163	4030016930	S.CER ECJ0EB1A104K	B	81.3/58.2
C164	4030016930	S.CER ECJ0EB1A104K	B	49.5/36.8
C165	4030016930	S.CER ECJ0EB1A104K	B	81.8/66.4
C166	4030017460	S.CER ECJ0EB1E102K	B	82.3/58.2
C167	4030017460	S.CER ECJ0EB1E102K	B	81.8/67.3
C168	4030017400	S.CER ECJ0EC1H220J	B	29.9/122.2
C169	4030018070	S.CER ECJ0EC1H300J	B	30.8/122.2
C170	4030018070	S.CER ECJ0EC1H300J	B	28.7/114.6
C171	4030017390	S.CER ECJ0EC1H180J	B	28.7/113.7
C172	4030017510	S.CER ECJ0EC1H680J	B	85.8/63.9
C173	4030017550	S.CER ECJ0EC1H1R5B	B	93/66.4
C174	4030017420	S.CER ECJ0EC1H470J	B	84.4/54.1
C175	4030017460	S.CER ECJ0EB1E102K	T	93.1/53.9
C176	4030018860	S.CER ECJ0EB0J105K	B	90.9/57.7
C177	4030017600	S.CER ECJ0EC1H080C	B	36.7/123.3
C178	4030017600	S.CER ECJ0EC1H080C	B	37.6/111.1
C179	4030017420	S.CER ECJ0EC1H470J	T	14.9/129.1
C180	4030017640	S.CER ECJ0EC1H150J	B	91.7/65
C181	4030017400	S.CER ECJ0EC1H220J	B	83.4/54.1
C182	4030016790	S.CER ECJ0EB1C103K	B	63.1/104.4
C183	4030017420	S.CER ECJ0EC1H470J	T	14.9/131.3
C184	4030017670	S.CER ECJ0EC1H390J	B	37.9/124.9
C185	4030018010	S.CER ECJ0EC1H360J	B	37.6/115.6
C186	4030017420	S.CER ECJ0EC1H470J	T	93.1/57.7
C187	4030017420	S.CER ECJ0EC1H470J	T	95.3/67.6
C188	4030017650	S.CER ECJ0EC1H270J	B	84.9/63.9
C189	4030017620	S.CER ECJ0EC1H100C	B	93.1/51.4
C190	4030017550	S.CER ECJ0EC1H1R5B	B	93.1/56.8
C191	4030017660	S.CER ECJ0EC1H330J	B	93/65.5
C192	4030017670	S.CER ECJ0EC1H390J	B	93.1/55.9
C193	4030017460	S.CER ECJ0EB1E102K	B	61.4/107.1
C194	4030017660	S.CER ECJ0EC1H330J	B	37.9/123.1
C195	4030017670	S.CER ECJ0EC1H390J	B	40.3/120.7
C196	4030018010	S.CER ECJ0EC1H360J	B	37.6/113.8
C197	4030017670	S.CER ECJ0EC1H390J	B	41.7/112.2
C198	4030016790	S.CER ECJ0EB1C103K	B	60.5/107.1
C199	4030017460	S.CER ECJ0EB1E102K	T	95.3/63.1
C200	4030017650	S.CER ECJ0EC1H270J	B	93/63.7
C201	4030017660	S.CER ECJ0EC1H330J	B	96/62
C202	4030017670	S.CER ECJ0EC1H390J	B	93.1/54.1
C203	4030017420	S.CER ECJ0EC1H470J	B	97.2/52
C204	4550006250	S.TAN TEESVA 1A 106M8R	T	81.6/17
C205	4550006250	S.TAN TEESVA 1A 106M8R	T	85.1/17
C206	4550006250	S.TAN TEESVA 1A 106M8R	T	88.5/17
C208	4030018860	S.CER ECJ0EB0J105K	T	80/17
C209	4030018860	S.CER ECJ0EB0J105K	T	83.5/17
C210	4030018860	S.CER ECJ0EB0J105K	T	86.9/17
C211	4030016930	S.CER ECJ0EB1A104K	B	38.5/120.7
C212	4030016790	S.CER ECJ0EB1C103K	B	39.9/112.2
C213	4030017650	S.CER ECJ0EC1H270J	B	68.5/106.1
C214	4030017460	S.CER ECJ0EB1E102K	B	66.8/107
C215	4030017540	S.CER ECJ0EC1HR75B	B	42.8/118.5
C216	4030017540	S.CER ECJ0EC1HR75B	B	42.8/116.9
C217	4030017460	S.CER ECJ0EB1E102K	B	39.4/120.7
C218	4030017460	S.CER ECJ0EB1E102K	B	40.8/112.2
C219	4030016790	S.CER ECJ0EB1C103K	B	94.2/62
C220	4030017530	S.CER ECJ0EC1HOR5B	B	98.5/59.6
C221	4030016790	S.CER ECJ0EB1C103K	B	95.4/52
C222	4030017530	S.CER ECJ0EC1HOR5B	B	99.4/56.6
C224	4030017460	S.CER ECJ0EB1E102K	B	95.1/62
C225	4030017460	S.CER ECJ0EB1E102K	B	96.3/52
C228	4030018860	S.CER ECJ0EB0J105K	T	79.9/24
C229	4030018860	S.CER ECJ0EB0J105K	T	83.5/24
C230	4030018860	S.CER ECJ0EB0J105K	T	86.8/24
C231	4550005980	S.TAN TEESVA 1A 475M8R	T	81.6/25.6
C232	4550005980	S.TAN TEESVA 1A 475M8R	T	85.1/25.6
C233	4550005980	S.TAN TEESVA 1A 475M8R	T	88.5/25.6
C235	4030017030	S.CER ECJ0EB1A273K	T	41/55
C236	4030017730	S.CER ECJ0EB1E471K	B	100.6/55
C237	4030017460	S.CER ECJ0EB1E102K	B	100.6/60.4
C238	4030017730	S.CER ECJ0EB1E471K	B	44.9/113.8
C239	4030017460	S.CER ECJ0EB1E102K	B	44.9/119.2
C240	4510009550	S.ELE EEEFK1C100R	T	95.1/22.3
C241	4030017350	S.CER ECJ0EC1H020B	B	68.3/120.9
C242	4030016790	S.CER ECJ0EB1C103K	B	68.7/111.2
C243	4030017460	S.CER ECJ0EB1E102K	B	70.3/106.1
C244	4030016790	S.CER ECJ0EB1C103K	B	70.3/107
C245	4030017460	S.CER ECJ0EB1E102K	B	94.8/60.2
C246	4030017620	S.CER ECJ0EC1H100C	T	46.9/114.7
C247	4030017460	S.CER ECJ0EB1E102K	B	42.6/112.2
C248	4030017460	S.CER ECJ0EB1E102K	B	36/117.8
C249	4030017420	S.CER ECJ0EC1H470J	B	48/112.2
C250	4030017590	S.CER ECJ0EC1H070C	B	103.7/58.7
C251	4030017620	S.CER ECJ0EC1H100C	B	102.6/55.9
C252	4030017460	S.CER ECJ0EB1E102K	B	99.2/51.3
C253	4030017590	S.CER ECJ0EC1H070C	B	48/117.4
C254	4030017460	S.CER ECJ0EB1E102K	B	103.7/53
C255	4030016930	S.CER ECJ0EB1A104K	T	42.1/50.6
C256	4030017640	S.CER ECJ0EC1H150J	T	43.1/55
C257	4030016790	S.CER ECJ0EB1C103K	T	36.5/58.8
C258	4030017390	S.CER ECJ0EC1H180J	B	59.6/117.8
C259	4030017580	S.CER ECJ0EC1H060C	T	48.5/46.4
C260	4030017460	S.CER ECJ0EB1E102K	B	46.5/107.5
C261	4030017460	S.CER ECJ0EB1E102K	B	47.7/110.3

[MAIN UNIT]

REF NO.	ORDER NO.	DESCRIPTION	M.	H/V LOCATION
C262	4030016930	S.CER ECJ0EB1A104K	T	69.2/57.5
C263	4030017460	S.CER ECJ0EB1E102K	B	60.5/126.1
C264	4030017460	S.CER ECJ0EB1E102K	B	101.9/48.9
C265	4030017460	S.CER ECJ0EB1E102K	B	43.5/120.7
C266	4030018900	S.CER ECJ0EB0J474K	T	43.7/45.6
C267	4030017660	S.CER ECJ0EC1H330J	B	59.6/119.3
C268	4030017460	S.CER ECJ0EB1E102K	B	62.3/126.1
C269	4550006780	S.TAN TEESVB2 0J 476M8R	T	72.2/60.7
C270	4030016930	S.CER ECJ0EB1A104K	T	40.5/49.7
C271	4030017610	S.CER ECJ0EC1H090C [EUR-01]	B	70.7/137.8
	4030017620	S.CER ECJ0EC1H100C [USA-01], [EXP-01]	B	70.7/137.8
C272	4030017630	S.CER ECJ0EC1H120J	T	47.3/60.1
C274	4030017460	S.CER ECJ0EB1E102K	B	44.4/120.7
C275	4030017620	S.CER ECJ0EC1H100C	B	48/124.4
C276	4030017600	S.CER ECJ0EC1H080C	B	71.9/139.9
C277	4030016790	S.CER ECJ0EB1C103K	T	48.6/36.7
C279	4030017390	S.CER ECJ0EC1H180J	B	59.6/120.9
C280	4030017460	S.CER ECJ0EB1E102K	B	98.9/66.3
C281	4030017460	S.CER ECJ0EB1E102K	B	100/62
C282	4030017630	S.CER ECJ0EC1H120J	B	61.4/122.2
C283	4030017620	S.CER ECJ0EC1H100C	B	103.7/65.9
C286	4030017570	S.CER ECJ0EC1H040B	B	61.4/140.3
C287	4030017350	S.CER ECJ0EC1H020B	B	58.2/138.5
C288	4030017570	S.CER ECJ0EC1H040B	B	64.1/139.8
C289	4030017570	S.CER ECJ0EC1H040B [USA-01], [EXP-01] [EUR-01]	B	71.9/135.7
	4030017600	S.CER ECJ0EC1H080C [EUR-01]	B	71.9/135.7
C290	4030017600	S.CER ECJ0EC1H080C	B	70.7/139.5
C291	4030017340	S.CER ECJ0EC1H010B	B	102.4/66.6
C292	4030017460	S.CER ECJ0EB1E102K	B	61.4/136.7
C293	4030017570	S.CER ECJ0EC1H040B	B	44/100.2
C294	4030017360	S.CER ECJ0EC1H030B	B	47.7/108.1
C295	4030017460	S.CER ECJ0EB1E102K	B	61.4/135.8
C296	4030017200	S.CER GRM31BR32J102KY01L	B	98.7/132.7
C297	4030017580	S.CER ECJ0EC1H060C	B	88.8/138.9
C298	4030017460	S.CER ECJ0EB1E102K	B	132.9/86.7
C299	4030017460	S.CER ECJ0EB1E102K	B	58.2/137.6
C300	4030017460	S.CER ECJ0EB1E102K	B	58.2/134.9
C301	4030016790	S.CER ECJ0EB1C103K	B	58.2/136.7
C302	4030017460	S.CER ECJ0EB1E102K	B	54.2/139.8
C303	4030017400	S.CER ECJ0EC1H220J	B	131.1/82.4
C304	4030017420	S.CER ECJ0EC1H470J	B	133.8/86.7
C305	4030017420	S.CER ECJ0EC1H470J	B	47.4/134.3
C306	4030017460	S.CER ECJ0EB1E102K	B	48.4/134.3
C307	4030017460	S.CER ECJ0EB1E102K	B	46.5/138.8
C309	4030016790	S.CER ECJ0EB1C103K	B	134.7/88.4
C310	4030017630	S.CER ECJ0EC1H120J	B	136.5/86.7
C311	4030016930	S.CER ECJ0EB1A104K	B	46.5/140.4
C312	4030016930	S.CER ECJ0EB1A104K	B	51.4/142.5
C313	4030016930	S.CER ECJ0EB1A104K	B	47.4/140.4
C314	4030017460	S.CER ECJ0EB1E102K	B	50.4/142.5
C315	4030017730	S.CER ECJ0EB1E471K	B	136.5/92.3
C318	4030017460	S.CER ECJ0EB1E102K [EUR-01] only	T	117.8/106.3
C319	4030017460	S.CER ECJ0EB1E102K [EUR-01] only	T	117.8/105.4
C320	4030017460	S.CER ECJ0EB1E102K [EUR-01] only	T	115.2/106.3
C321	4030017420	S.CER ECJ0EC1H470J	T	66/57.5
C322	4030017420	S.CER ECJ0EC1H470J	T	62.3/52.9
C323	4030017350	S.CER ECJ0EC1H020J [USA-01], [EXP-01] [EUR-01]	B	45.6/138.8
	4030017550	S.CER ECJ0EC1H1R5B [EUR-01]	B	45.6/138.8
C324	4030017630	S.CER ECJ0EC1H120J	B	135.6/83.3
C325	4030017460	S.CER ECJ0EB1E102K	B	134.7/90.1
C326	4030017590	S.CER ECJ0EC1H070C [USA-01], [EXP-01]	B	38.7/139
C327	4030017640	S.CER ECJ0EC1H150J	B	142.8/85
C328	4030017420	S.CER ECJ0EC1H470J	B	137.8/92.3
C329	4030017640	S.CER ECJ0EC1H150C	B	36/142.3
C330	4030017460	S.CER ECJ0EB1E102K	B	138.9/92.3
C331	4030017460	S.CER ECJ0EB1E102K	B	60.4/142.5
C332	4030017460	S.CER ECJ0EB1E102K	B	56/142.5
C333	4030016930	S.CER ECJ0EB1A104K	T	23.1/29.4
C334	4510009810	S.ELE EEEFK1E220R	T	137.5/89.8
C335	4030017390	S.CER ECJ0EC1H180J	B	144.3/89.3
C336	4030017420	S.CER ECJ0EC1H470J	B	61.3/142.5
C337	4030017400	S.CER ECJ0EC1H220J	B	144.3/88.2
C338	4030017340	S.CER ECJ0EC1H010B [USA-01], [EXP-01] [EUR-01]	B	36/139.4
	4030017460	S.CER ECJ0EB1E102K [EUR-01]	B	36/139.4
C339	4030017460	S.CER ECJ0EB1E102K	B	36/135.7
C340	4030016930	S.CER ECJ0EB1A104K	T	54/20.3
C341	4030017420	S.CER ECJ0EC1H470J	B	132.9/90.1
C342	4030017730	S.CER ECJ0EB1E471K	T	138.8/108
C343	4550002890	S.TAN TEESVA 1A 225M8R	T	148.3/126
C345	4030017460	S.CER ECJ0EB1E102K	B	36/134.8
C346	4030017420	S.CER ECJ0EC1H470J	T	63.2/56.9
C347	4030017460	S.CER ECJ0EB1E102K	T	145/127.7
C348	4030017420	S.CER ECJ0EC1H470J	T	64.2/55.5

[MAIN UNIT]

REF NO.	ORDER NO.	DESCRIPTION	M.	H/V LOCATION
C364	4030011040	S.CER GRM31M4C2H2R0CY21L [USA-01], [EXP-01]	B	93.3/119.2
C365	4030017730	S.CER ECJ0EB1E471K	T	114.8/117
C366	4030016930	S.CER ECJ0EB1A104K [EUR-01]	T	145/124.4
	4030018900	S.CER ECJ0EB0J474K [USA-01], [EXP-01]	T	145/124.4
C367	4510009810	S.ELE EEEFK1E220R	T	110.3/113.1
C368	4030006860	S.CER C1608 JB 1H 102K-T	T	87.7/142
C370	4030011120	S.CER GRM31M2C2H100JV01L	B	97.4/123.5
C371	4030007060	S.CER C1608 JB 1H 270K-T	T	35.5/142.5
C372	4030011050	S.CER GRM31M3C2H3R0CY21L [USA-01], [EXP-01]	B	101/122
C373	4030016930	S.CER ECJ0EB1A104K	T	140.4/122.5
C374	4030017460	S.CER ECJ0EB1E102K	B	89.6/115.1
C375	4030017460	S.CER ECJ0EB1E102K	T	110.7/108.7
C376	4030017600	S.CER ECJ0EC1H080C	B	85/138.9
C377	4030017730	S.CER ECJ0EB1E471K	B	84.2/119.4
C378	4030017420	S.CER ECJ0EC1H470J	T	110.7/109.6
C379	4030017380	S.CER ECJ0EC1H050B [USA-01], [EXP-01]	B	25.1/144.5
	4030017580	S.CER ECJ0EC1H060C [EUR-01]	B	25.1/144.5
	4030017380	S.CER ECJ0EC1H050B	B	87.2/138.9
C381	4030017400	S.CER ECJ0EC1H220J	T	112.1/117
C382	4030017580	S.CER ECJ0EC1H060C	B	24.1/141
C383	4030017460	S.CER ECJ0EB1E102K	T	115.3/75.6
C384	4030018860	S.CER ECJ0EB0J105K	T	138.6/127.7
C385	4030017660	S.CER ECJ0EB1E330K	B	23.2/144.4
C386	4030017460	S.CER ECJ0EB1E102K	T	136.6/127.7
C387	4030017390	S.CER ECJ0EC1H180J	B	86/135.9
C388	4510009550	S.ELE EEEFK1C100R	T	123.3/76.8
C389	4030017200	S.CER GRM31BR32J102KY01L	B	94.2/132.5
C390	4030011170	S.CER GRM31M2C2H180JV01L	B	84.7/131.6
C391	4030017460	S.CER ECJ0EB1E102K	T	115.3/74
C392	4030017520	S.CER ECJ0EC1H0R3B	B	86/130
C394	4550006250	S.TAN TEESVA 1A 106M8R	B	26.3/15.3
C396	4510009550	S.ELE EEEFK1C100R	T	97/77.8
C397	4030017460	S.CER ECJ0EB1E102K	T	136.6/122.5
C398	4550006250	S.TAN TEESVA 1A 106M8R	B	31.7/15.5
C399	4030017460	S.CER ECJ0EB1E102K	T	100/76.1
C400	4030017460	S.CER ECJ0EB1E102K	B	85.6/103.9
C401	4030011170	S.CER GRM31M2C2H180JV01L	B	103.4/131.2
C402	4030016930	S.CER ECJ0EB1A104K	T	47.2/71.6
C404	4030017460	S.CER ECJ0EB1E102K	T	143.1/127.7
C405	4030017420	S.CER ECJ0EC1H470J	B	57.6/56.9
C406	4030016790	S.CER ECJ0EB1C103K	T	103.5/76.2
C408	4030017460	S.CER ECJ0EB1E102K	B	85.6/127.6
C409	4030011170	S.CER GRM31M2C2H180JV01L	B	112.4/131.2
C410	4030011170	S.CER GRM31M2C2H180JV01L	B	114.6/131.2
C411	4550007650	S.TAN F931V105MAABMA	T	37.5/68.6
C412	4030017460	S.CER ECJ0EB1E102K	T	104.5/77.8
C413	4030016930	S.CER ECJ0EB1A104K	T	38.5/71.9
C414	4030017420	S.CER ECJ0EC1H470J	B	37.6/134
C415	4550007650	S.TAN F931V105MAABMA	T	37.5/63.4
C416	4550006250	S.TAN TEESVA 1A 106M8R	T	106.9/81.6
C417	4030016930	S.CER ECJ0EB1A104K	T	15/125.7
C418	4550007650	S.TAN F931V105MAABMA	T	39.4/73.9
C419	4030011170	S.CER GRM31M2C2H180JV01L	B	117.3/131.2
C420	4030016930	S.CER ECJ0EB1A104K	B	27.4/18.5
C421	4030017460	S.CER ECJ0EB1E102K	B	86.5/127.6
C422	4030017730	S.CER ECJ0EB1E471K	B	119.6/139.5
C423	4030017460	S.CER ECJ0EB1E102K	B	121.5/145.1
C424	4030016930	S.CER ECJ0EB1A104K	T	14.1/125.7
C426	4030017640	S.CER ECJ0EC1H150J	B	120.9/139.5
C428	4030017390	S.CER ECJ0EC1H180J	B	144.3/86.6
C429	4030017460	S.CER ECJ0EB1E102K	B	122.4/143.4
C431	4030018860	S.CER ECJ0EB0J105K	B	33.3/13.6
C432	4030016930	S.CER ECJ0EB1A104K	T	10.8/120.6
C433	4030017730	S.CER ECJ0EB1E471K	B	139.5/138.1
C434	4030017460	S.CER ECJ0EB1E102K	B	137.7/133.5
C435	4030017460	S.CER ECJ0EB1E102K	T	54.8/29.8
C436	4030011170	S.CER GRM31M2C2H180JV01L	B	143.7/137
C437	4030016930	S.CER ECJ0EB1A104K	B	34.4/12
C438	4030016790	S.CER ECJ0EB1C103K	T	109.7/89
C439	4510009810	S.ELE EEEFK1E220R	T	129.9/96.8
C440	4030018900	S.CER ECJ0EB0J474K	T	7.9/129.6
C441	4030017440	S.CER ECJ0EC1H221J	T	12/126.2
C442	4510009680	S.ELE EEEFK1E471P	B	9.6/119.8
C443	4030017460	S.CER ECJ0EB1E102K	T	108.8/89
C444	4030011170	S.CER GRM31M2C2H180JV01L	B	147/148.9
C445	4030017600	S.CER ECJ0EC1H080C	B	26.1/141
C446	4030017460	S.CER ECJ0EB1E102K	T	6.6/130.1
C448	4030017460	S.CER ECJ0EB1E102K	T	126.9/103.4
C449	4510008870	S.ELE EEE1AA471UP	B	8.9/139.2
C450	4030016930	S.CER ECJ0EB1A104K	T	7/125.3
C451	4030018860	S.CER ECJ0EB0J105K	T	8.6/125.3
C452	4030018860	S.CER ECJ0EB0J105K	T	71.5/98.2
C453	4030017460	S.CER ECJ0EB1E102K	T	127.9/103.4
C454	4030017430	S.CER ECJ0EC1H101J	B	46.3/56.9
C458	4030017460	S.CER ECJ0EB1E102K	T	129.6/113.3
C459	4030017460	S.CER ECJ0EB1E102K	T	117.8/117.7
C460	4030017460	S.CER ECJ0EB1E102K	B	9.6/147.3
C461	4030017420	S.CER ECJ0EC1H470J	T	130.5/113.3
C462	4030017420	S.CER ECJ0EC1H470J	T	117.8/116.7
C463	4030017420	S.CER ECJ0EC1H470J	B	9.6/146.4
C464	4510009680	S.ELE EEEFK1E471P	B	144.4/121.1
C465	4550006250	S.TAN TEESVA 1A 106M8R	T	96.1/87.8
C466	4030017420	S.CER ECJ0EC1H470J	T	99.9/88
C467	4030016930	S.CER ECJ0EB1A104K	T	62.3/58.5
C468	4030016930	S.CER ECJ0EB1A104K	T	61.7/56.9
C469	4030017460	S.CER ECJ0EB1E102K	B	141.3/90.1
C470	4030018860	S.CER ECJ0EB0J105K	T	7.4/122.3
C471	4030016790	S.CER ECJ0EB1C103K	T	7/124.4
C472	4030018860	S.CER ECJ0EB0J105K	T	10.9/117.7
C473	4030018860	S.CER ECJ0EB0J105K	T	5/118.9

[MAIN UNIT]

REF NO.	ORDER NO.	DESCRIPTION	M.	H/V LOCATION
C474	4030017780	S.CER ECJ0EB1E472K	T	115.3/17.6
C475	4510008120	S.ELE 16 CE 100 BS	T	125.1/12.1
C476	4510008120	S.ELE 16 CE 100 BS	T	125.1/19.3
C477	4030017780	S.CER ECJ0EB1E472K	T	118.9/12.2
C478	4030017780	S.CER ECJ0EB1E472K	T	115.3/12.2
C479	4510008120	S.ELE 16 CE 100 BS	T	104.8/14.3
C481	4030017460	S.CER ECJ0EB1E102K	B	63.2/122.2
C491	4030016930	S.CER ECJ0EB1A104K	T	60.4/60.1
C492	4030016930	S.CER ECJ0EB1A104K	B	13.5/32.6
C493	4510008870	S.ELE EEE1AA471UP	B	66.3/45.3
C494	4030016930	S.CER ECJ0EB1A104K	T	101.5/92.4
C495	4030016930	S.CER ECJ0EB1A104K	T	101.5/90.1
C496	4030016930	S.CER ECJ0EB1A104K	T	123.3/92.9
C497	4030016930	S.CER ECJ0EB1A104K	T	109.9/81.2
C498	4030016930	S.CER ECJ0EB1A104K	T	11.4/43.2
C501	4030017420	S.CER ECJ0EC1H470J	T	11.7/31.2
C502	4030017460	S.CER ECJ0EB1E102K	T	29.5/2.8
C503	4030017420	S.CER ECJ0EC1H470J	T	48/99.4
C506	4030016930	S.CER ECJ0EB1A104K	B	26.3/43.3
C507	4030016930	S.CER ECJ0EB1A104K	B	32.9/31
C508	4030016930	S.CER ECJ0EB1A104K	B	40.1/42.7
C509	4030016930	S.CER ECJ0EB1A104K	B	26.2/39
C510	4030016930	S.CER ECJ0EB1A104K	B	26.6/33
C511	4030016930	S.CER ECJ0EB1A104K	B	40.1/34.2
C512	4030017420	S.CER ECJ0EC1H470J	T	92/14.7
C513	4550006250	S.TAN TEESVA 1A 106M8R	B	8.4/59.8
C514	4030016930	S.CER ECJ0EB1A104K	B	11.7/53.5
C515	4030016930	S.CER ECJ0EB1A104K	B	15.5/54.4
C516	4030016930	S.CER ECJ0EB1A104K	T	65.1/69.6
C517	4030016930	S.CER ECJ0EB1A104K	B	15.6/63.1
C518	4030016930	S.CER ECJ0EB1A104K	B	12.4/62.9
C519	4030017460	S.CER ECJ0EB1E102K	B	15.6/59.9
C521	4030016930	S.CER ECJ0EB1A104K	B	18.1/53.6
C522	4030016930	S.CER ECJ0EB1A104K	T	51.2/31.8
C523	4030016930	S.CER ECJ0EB1A104K	T	51.2/33
C524	4030018910	S.CER C1608 JB 0J 475K-T	T	9.5/56
C525	4030018910	S.CER C1608 JB 0J 475K-T	B	25.8/58.3
C526	4030017730	S.CER ECJ0EB1E471K	B	29.8/57.9
C527	4030016790	S.CER ECJ0EB1C103K	B	26.1/50.3
C528	4030017670	S.CER ECJ0EC1H390J	B	37.6/120.7
C529	4030017630	S.CER ECJ0EC1H120J	B	39/112.2
C530	4030017420	S.CER ECJ0EC1H470J	T	58.7/62.6
C531	4030017670	S.CER ECJ0EC1H390J	B	93/61.9
C532	4030017670	S.CER ECJ0EC1H390J	B	94.5/52
C533	4510008120	S.ELE 16 CE 100 BS	T	125.1/26.4
C534	4030016790	S.CER ECJ0EB1C103K	T	118.4/26.7
C535	4030016790	S.CER ECJ0EB1C103K	B	66.4/102.5
C536	4030016790	S.CER ECJ0EB1C103K	B	64.8/99.1
C538	4030006860	S.CER C1608 JB 1H 102K-T	T	36.2/145.1
C539	4030017790	S.CER ECJ0EB1E682K	T	22.8/57
C540	4030017730	S.CER ECJ0EB1E471K	T	21.2/56.6
C541	4030016930	S.CER ECJ0EB1A104K	T	22.8/55.4
C542	4030017440	S.CER ECJ0EC1H221J	T	27.1/55
C543	4030016930	S.CER ECJ0EB1A104K	T	56.3/68.9
C544	4030017460	S.CER ECJ0EB1E102K	T	62.4/72.9
C545	40300011100	S.CER GRM31M2C2H8R0DV01L [EUR-01]	T	97.6/106.8
	4030011120	S.CER GRM31M2C2H100JV01L [USA-01], [EXP-01]	T	97.6/106.8
C546	4030018910	S.CER C1608 JB 0J 475K-T	B	40.4/56.7
C547	4030017760	S.CER ECJ0EB1H222K	T	53.7/72.1
C548	4030016930	S.CER ECJ0EB1A104K	T	14.1/120.6
C549	4030017420	S.CER ECJ0EC1H470J	T	22/85.7
C550	4030017420	S.CER ECJ0EC1H470J	T	71.5/85.1
C551	4030017330	S.CER ECJ0EF1C104Z	T	114.1/28.1
C552	4030016790	S.CER ECJ0EB1C103K	B	121.9/48.8
C553	4030016930	S.CER ECJ0EB1A104K	B	30.8/19.4
C555	4030016930	S.CER ECJ0EB1A104K	B	69.8/75.5
C556	4030016930	S.CER ECJ0EB1A104K	T	105.2/28.6
C557	4030016930	S.CER ECJ0EB1A104K	T</	

[MAIN UNIT]

REF NO.	ORDER NO.	DESCRIPTION	M.	H/V LOCATION
C617	4030017420	S.CER ECJ0EC1H470J	T	59.8/65
C618	4030017420	S.CER ECJ0EC1H470J	T	64.2/53.8
C619	4030017420	S.CER ECJ0EC1H470J	T	76.8/109.5
C620	4030017420	S.CER ECJ0EC1H470J	T	73.8/97.8
C621	4030017420	S.CER ECJ0EC1H470J	T	31.5/2.8
C622	4030018910	S.CER C1608 JB 0J 475K-T	T	64.3/73.2
C623	4030017330	S.CER ECJ0EF1C104Z	B	126.8/16
C624	4030017330	S.CER ECJ0EF1C104Z	B	126.3/20.3
C625	4030017460	S.CER ECJ0EB1E102K	B	126.8/17.2
C626	4510009810	S.ELE EEEFK1E220R	B	129.4/23
C629	4030016790	S.CER ECJ0EB1C103K	B	113.2/27.1
C630	4030016930	S.CER ECJ0EB1A104K	B	108.8/27.1
C631	4550007080	S.TAN TEESVA 1C 106M8R	B	104.6/26.8
C632	4550007080	S.TAN TEESVA 1C 106M8R	B	111/23.3
C633	4550007080	S.TAN TEESVA 1C 106M8R	B	105.8/23.3
C634	4030017460	S.CER ECJ0EB1E102K	B	108.4/22.1
C648	4510009680	S.ELE EEEFK1E471P	B	85.7/23.3
C649	4030018860	S.CER ECJ0EBOJ105K	T	71.2/64.2
J1	6510025220	S.CNR AXK540145J	T	23.1/63.7
J2	6510023091	S.CNR 20FLT-SM2-TB (LF) (SN)	T	14.8/15.6
J4	6510023511	S.CNR 28FLT-SM2-TB (LF) (SN)	T	70.8/102
J5	6510023110	CNR 3008L-8P8C <KIN>		
J6	6450000140	CNR HSJ0807-01-010		
J8	6510023091	S.CNR 20FLT-SM2-TB (LF) (SN)	T	59.1/15.6
J9	6510019371	S.CNR B3B-ZR-SM4-TF (LF) (SN)	T	94.6/14.3
J10	6510004910	CNR NR-DS-E 01		
J11	6510004910	CNR NR-DS-E 01		
DS1	5040002961	S.LED SML-A12MT T86J	B	96/1.1
DS2	5040002961	S.LED SML-A12MT T86J	B	126/1.1
DS3	5040003000	S.LED SML-A12UT-T86	B	111/1.1
MF1	2710000870	FAN AFB0512HB-7X22 <USE>HK		
W1	7120000470	JMP ERDS2T0		
W2	7120000470	JMP ERDS2T0		
W4	8900017520	CBL OPC-1783		
EP1	6910015370	S.BEA ACZ1005Y-102-T	B	129.1/48.4
EP2	6910015370	S.BEA ACZ1005Y-102-T	B	115.5/45.6
EP3	6910015370	S.BEA ACZ1005Y-102-T	B	32.4/81.6
EP4	6910016330	S.BEA MMZ1005S 601CT-S	B	30.4/60.5
EP5	6910015370	S.BEA ACZ1005Y-102-T	B	39/74.3
EP6	6910015370	S.BEA ACZ1005Y-102-T	T	38.5/108.3
EP7	6910016330	S.BEA MMZ1005S 601CT-S	B	40.7/36.7
EP8	6910015370	S.BEA ACZ1005Y-102-T	B	95.4/49
EP9	6910016330	S.BEA MMZ1005S 601CT-S	T	48.8/39.3
EP10	6910011560	BEA HF70BB4.5X5X1.6		
EP13	6910011330	TER OT-009 M3		
EP14	6910011330	TER OT-009 M3		
EP16	6910018460	S.BEA MMZ1005Y102C-T	T	64.1/105
EP17	6910018460	S.BEA MMZ1005Y102C-T	T	65.1/105
EP18	6910018460	S.BEA MMZ1005Y102C-T	T	66.1/105
EP19	6910018460	S.BEA MMZ1005Y102C-T	T	66.1/106.8
EP20	6910018460	S.BEA MMZ1005Y102C-T	T	62.8/98.7
EP21	6910018460	S.BEA MMZ1005Y102C-T	T	62.8/99.6
EP22	6910018460	S.BEA MMZ1005Y102C-T	T	74.1/105
EP23	6910018460	S.BEA MMZ1005Y102C-T	T	73.2/105
EP24	6910018460	S.BEA MMZ1005Y102C-T	T	72.3/105
EP25	6910018460	S.BEA MMZ1005Y102C-T	T	71.1/105
EP26	6910018460	S.BEA MMZ1005Y102C-T	T	72.4/99
EP27	6910018460	S.BEA MMZ1005Y102C-T	T	68.2/99.1
EP28	6910018460	S.BEA MMZ1005Y102C-T	T	67.3/99.1
EP29	6910018460	S.BEA MMZ1005Y102C-T	T	65.8/99.1
EP30	6910018460	S.BEA MMZ1005Y102C-T	T	74.3/99
EP31	6910018460	S.BEA MMZ1005Y102C-T	T	70.6/98.2

[CONNECT UNIT]

REF NO.	ORDER NO.	DESCRIPTION	M.	H/V LOCATION
C601	4030017420	S.CER ECJ0EC1H470J	T	13.8/12.4
C602	4030017400	S.CER ECJ0EC1H220J	T	12.2/12.4
C603	4030017420	S.CER ECJ0EC1H470J	T	16.5/12.4
C604	4030017400	S.CER ECJ0EC1H220J	T	15/14.2
C605	4030017420	S.CER ECJ0EC1H470J	T	17.8/13.9
C606	4030017420	S.CER ECJ0EC1H470J	T	19.4/12.4
C607	4030017420	S.CER ECJ0EC1H470J	T	20.5/13.9
C608	4030017420	S.CER ECJ0EC1H470J	T	22.6/12.4
C609	4030017420	S.CER ECJ0EC1H470J	T	25.5/12.4
C610	4030017420	S.CER ECJ0EC1H470J	T	29.7/12.8
C611	4030017420	S.CER ECJ0EC1H470J	T	31/14.1
C612	4030017420	S.CER ECJ0EC1H470J	T	32.4/12.8
C613	4030017420	S.CER ECJ0EC1H470J	T	33.5/14.1
C614	4030017420	S.CER ECJ0EC1H470J	T	35.2/14.1
C615	4030017420	S.CER ECJ0EC1H470J	T	35.7/12.8
C616	4030017420	S.CER ECJ0EC1H470J	B	35.2/15.6
C617	4030017420	S.CER ECJ0EC1H470J	T	37.5/13.5
C618	4030017420	S.CER ECJ0EC1H470J	T	39.3/12.2
C619	4030017420	S.CER ECJ0EC1H470J	T	39.9/13.4
C620	4030017420	S.CER ECJ0EC1H470J	T	41.3/12.6
C621	4030017420	S.CER ECJ0EC1H470J	T	27.4/13.9
J601	6510026290	S.CNR IMSA-9631S-28Y921	B	22.8/16.2
J602	6510023210	CNR CD6125SA1J0 <CVI>		
S1	2260003070	S.SW MINISMDC150F/24-2	B	38.9/18
W601	8900017500	CBL OPC-1852 (P0.5,N28,L90)		

M.=Mounted side (T: Mounted on the Top side, B: Mounted on the Bottom side)
S.=Surface mount

SECTION 8

MECHANICAL PARTS

[MAIN UNIT]

REF NO.	ORDER NO.	DESCRIPTION	QTY.
J1*	6510026770	AXK540147YG	1
J2*	6510023092	20FLT-SM2-TB (LF) (SN) (M)	1
J4*	6510023512	28FLT-SM2-TB (LF) (SN) (M)	1
J5	6510023110	3008L-8P8C	1
J6	6450000140	HSJ0807-01-010	1
J8*	6510023092	20FLT-SM2-TB (LF) (SN) (M)	1
J9*	6510019371	B3B-ZR-SM4-TF (LF) (SN)	1
J10	6510004910	NR-DSE-01	1
J11	6510004910	NR-DSE-01	1
MF1	2710000870	AFB0512HB-F00	1
W1	7120000470	ERDS2T0	1
W2	7120000470	ERDS2T0	1
W4	8900017520	OPC-1783	1
EP10	6910011560	HF70BB4.5X5X1.6	2
EP11	6910010280	HF70BB9.5X10.4X4.9	1
EP12	6910010280	HF70BB9.5X10.4X4.9	1
EP13	6910011330	OT-009 M3	1
EP14	6910011330	OT-009 M3	1
MP2	8510018060	2979 VCO COVER	1
MP3*	8510018070	2979 VCO CASE	1
MP4	8510018060	2979 VCO COVER	1
MP5	8210024440	3063 SUB M-PANEL	1
MP6	8310070880	3063 S-LED PLATE	1
MP7	8930073920	3063 SP COVER	1
MP8	8010020980	3063 CHASSIS	1
MP9	8110009360	3063 SU-COVER	1
MP10	8110009370	3063 SL-COVER	1
MP11	8930074300	3063 PC PLATE	1
MP12	8930074180	O-RING (BR)	1
MP13	8930075020	3063 B-PACKING	1
MP14	8930075030	3063 C-PACKING	1
MP15	8930073930	3063 SP RUBBER	1
MP17	8930062160	HIMELON SHEET (CL)	1
MP18	8930070921	2979 D-SUB PLATE-1	1
MP19	8930058990	SHIELD SPONGE (V)	1
MP20	8510015660	2681 F-SHIELD PLATE	1
MP21	8930048550	2177 CLIP	1
MP23	8930075080	DUST CAP HR25F	1
MP24	8810009611	SCREW M2.6X6 ZK3	8
MP25	8810009611	SCREW M2.6X6 ZK3	9
MP26	8810010780	SCREW BT B0 3X20NI-ZK3 (BT)	4
MP27	8810008661	SCREW BT B0 3X8 NI-ZC3 (BT)	19
MP28	8810008661	SCREW BT B0 3X8 NI-ZC3 (BT)	2
MP29	8810008661	SCREW BT B0 3X8 NI-ZC3 (BT)	1
MP30	8810008661	SCREW BT B0 3X8 NI-ZC3 (BT)	2
MP31	8810008661	SCREW BT B0 3X8 NI-ZC3 (BT)	3
MP32	8810008661	SCREW BT B0 3X8 NI-ZC3 (BT)	4
MP33	8510018780	3063 ANT CASE	2
MP35	8810003361	SETSCREW (C) 3X6 ZC3	2
MP37	8510018790	3063 VCO SHIELD	1
MP38	8510018820	3063 SHIELD PLATE	1
MP40	8930050472	SHIELD SPONGE (A)-2	1
MP41	8930050472	SHIELD SPONGE (A)-2	1
MP42	8930050472	SHIELD SPONGE (A)-2	1

[CONNECT UNIT]

REF NO.	ORDER NO.	DESCRIPTION	QTY.
J601*	6510026290	IMSA-9631S-28Y921	1
J602	6510023210	CD6125SA1J0	1
S1*	2260003070	MINISMDC150F/24	1
W601	8900017500	OPC-1852	1

[ACCESSORIES]

REF NO.	ORDER NO.	DESCRIPTION	QTY.
W1	8900017530	OPC-1784	1
W2	8900017540	OPC-1785	1
MP1	8930073980	3063 ANGLE	2
MP2	8810008661	SCREW BT B0 3X8 NI-ZC3 (BT)	2
MP3	8810003361	SETSCREW (C) 3X6 ZC3	4
MP4	8810008451	SCREW BiH M4X8 ZK3	4

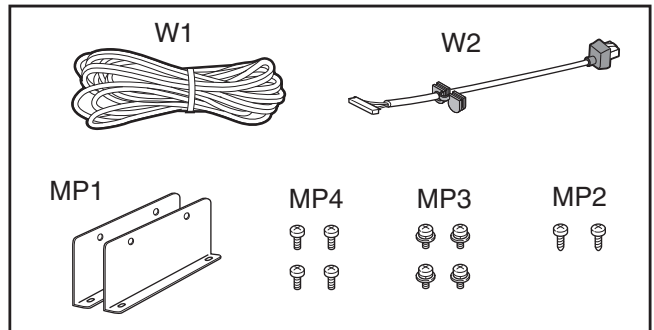

*: Refer to "BOARD LAYOUTS" for the location.

Screw abbreviations A, B0, BT: Self-tapping PH: Pan head ZK: Black NI-ZU: Nickel-Zinc SUS: Stainless

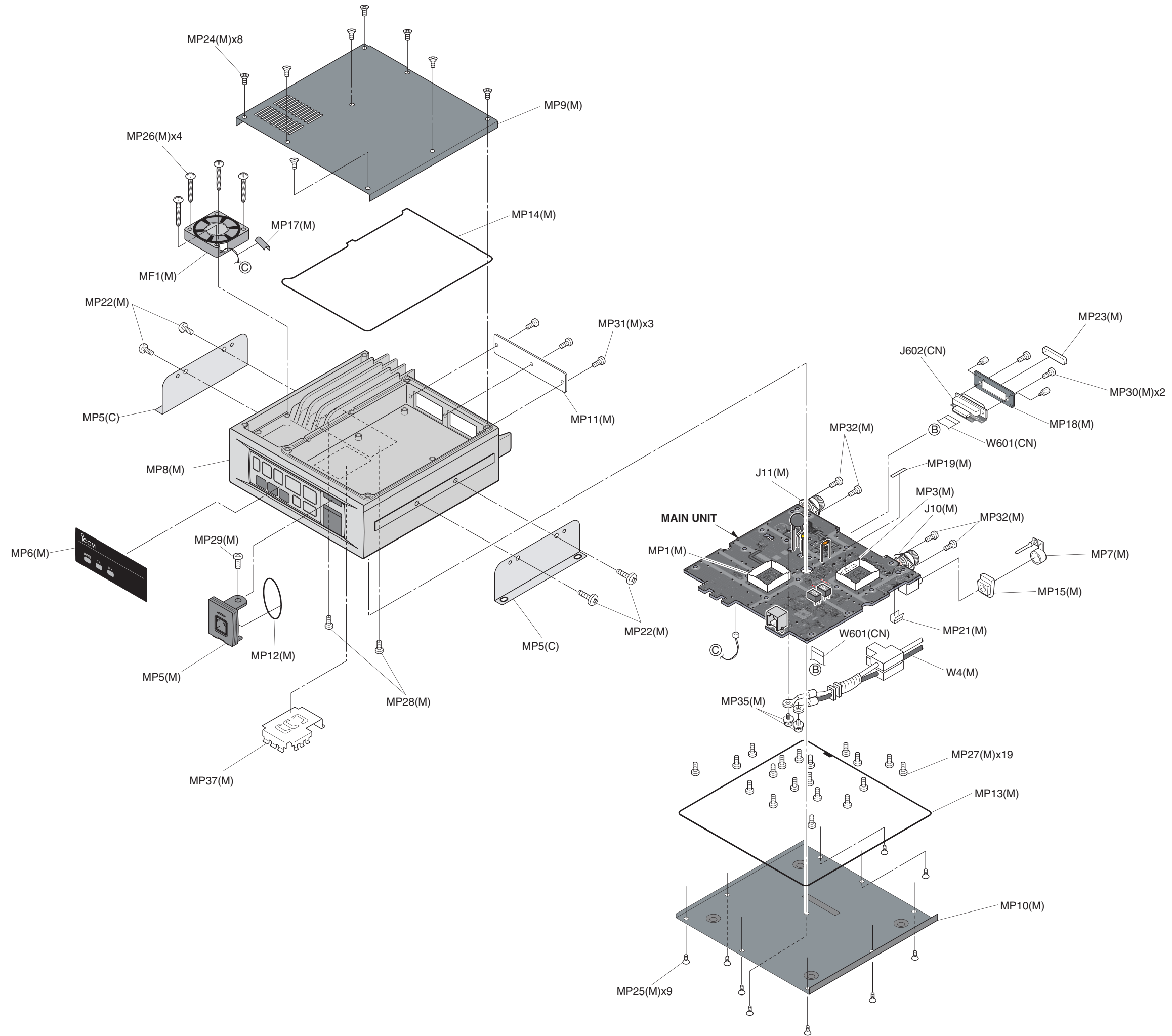

Unit abbreviations;
 (C) : CHASSIS PARTS
 (F) : FRONT UNIT
 (M) : MAIN UNIT
 (CN) : CONNECTOR UNIT

SECTION 9

BOARD LAYOUTS

• MAIN UNIT (TOP VIEW)

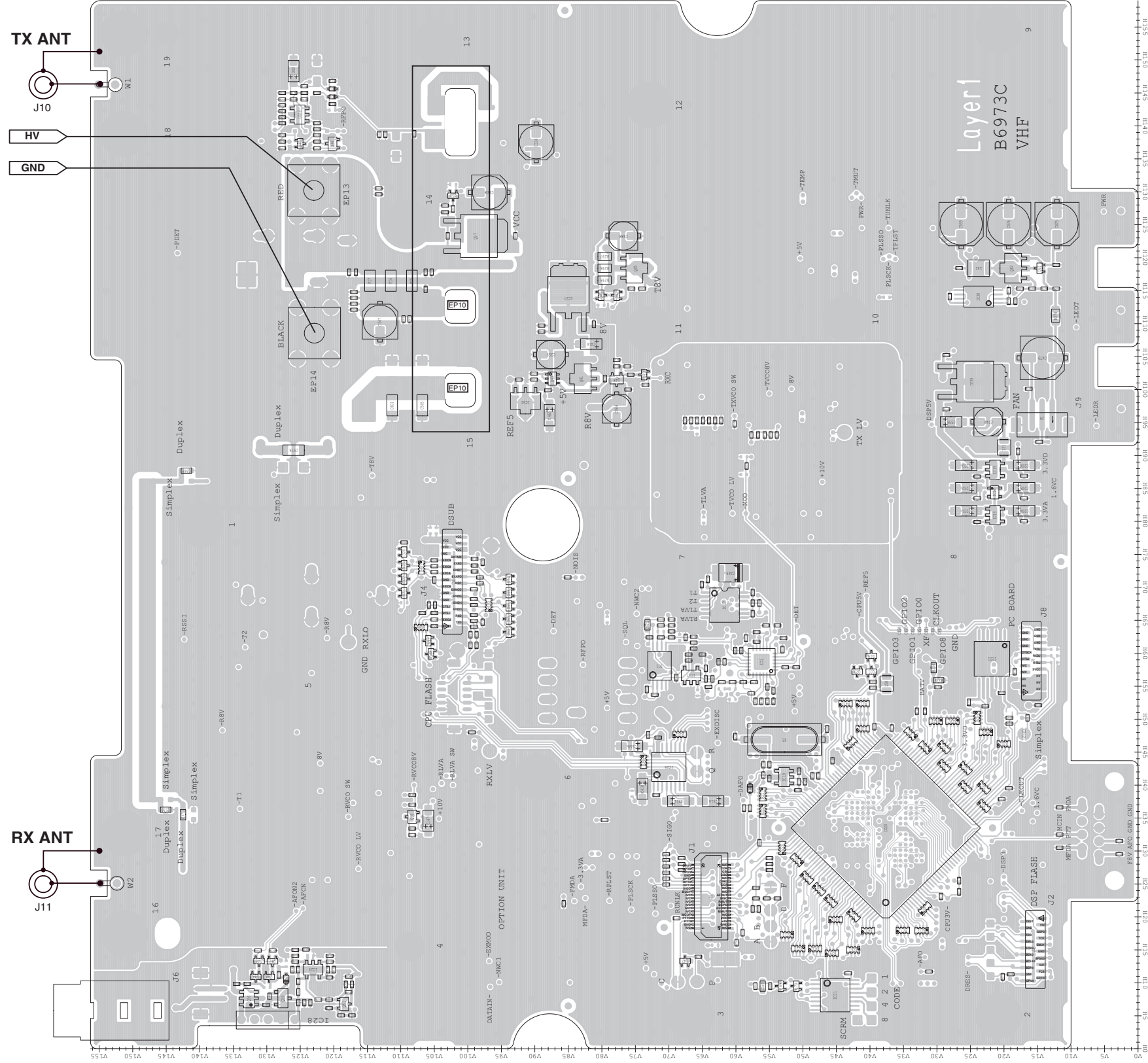

• FRONT UNIT (TOP VIEW)

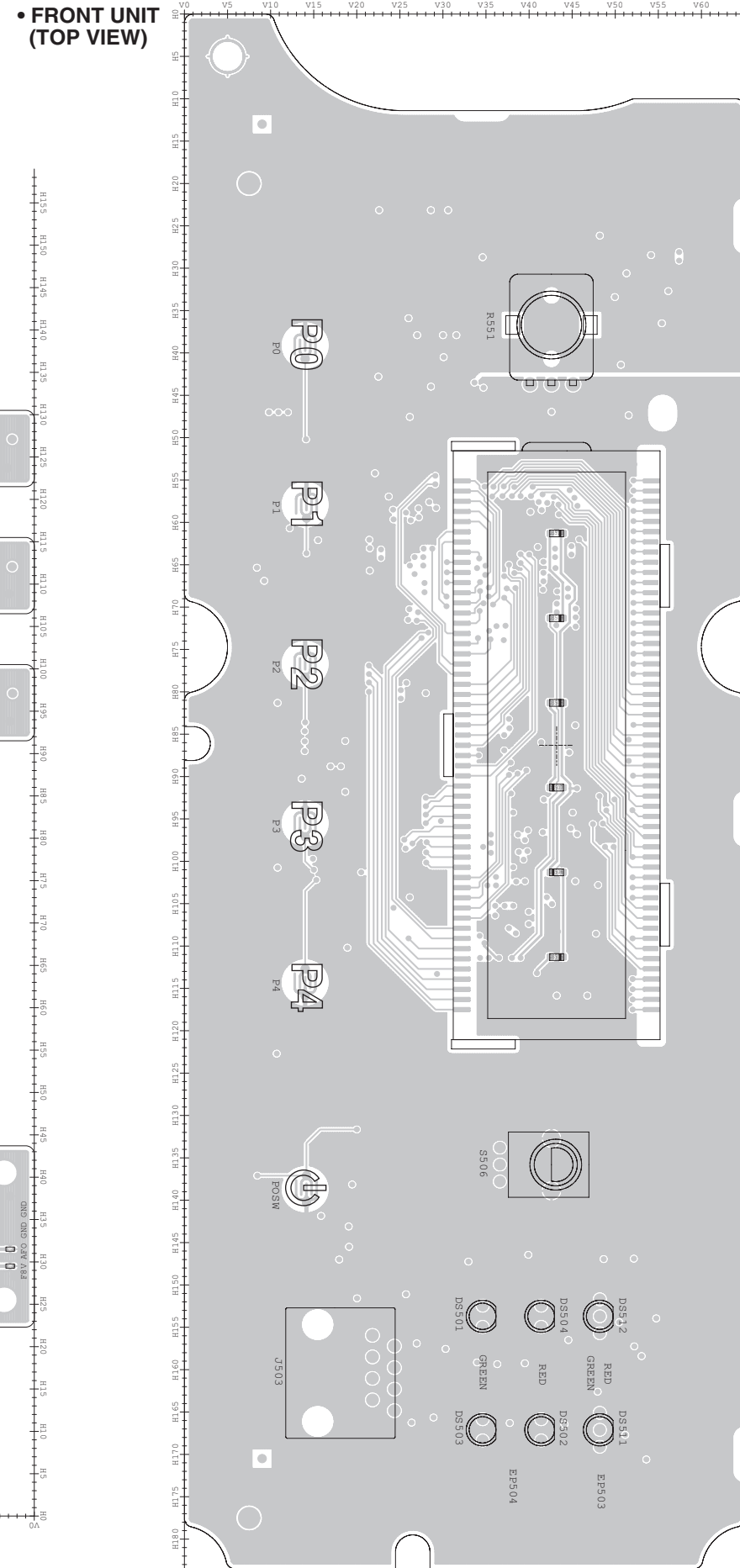

• CONNECT UNIT (TOP VIEW)

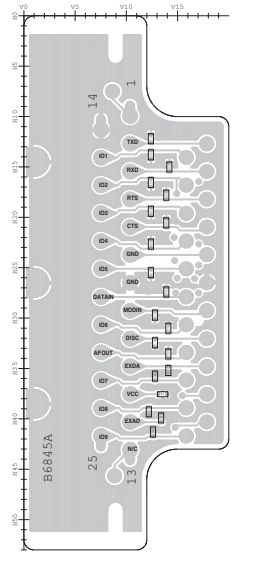

• CONNECT UNIT
(BOTTOM VIEW)

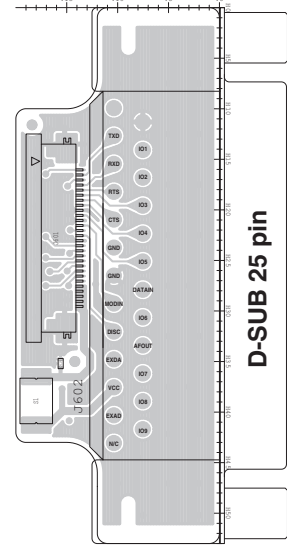

SP1

• FRONT UNIT
(BOTTOM VIEW)

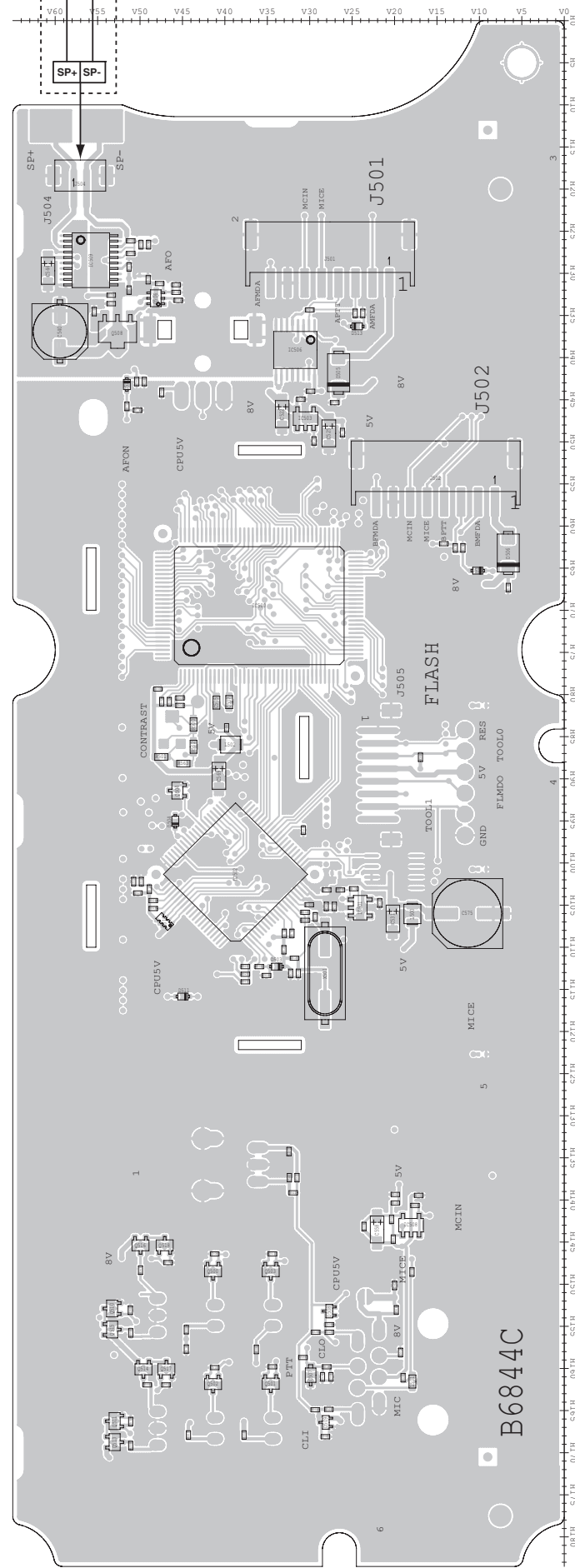

The combination of this side and the bottom side shows the board layout in the same configuration as the actual P.C.Board.

• MAIN UNIT
(BOTTOM VIEW)

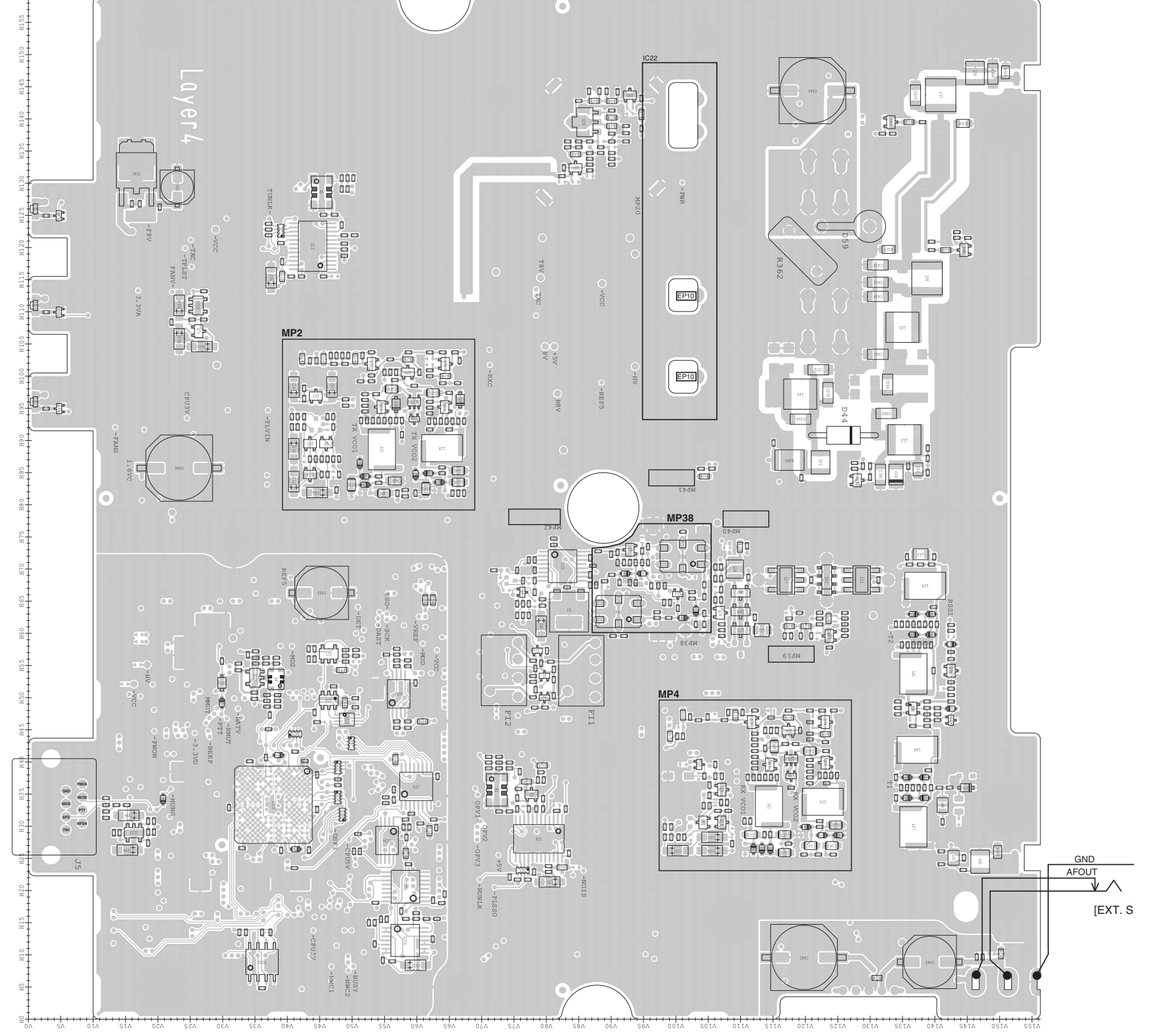

SECTION 10

BLOCK DIAGRAM

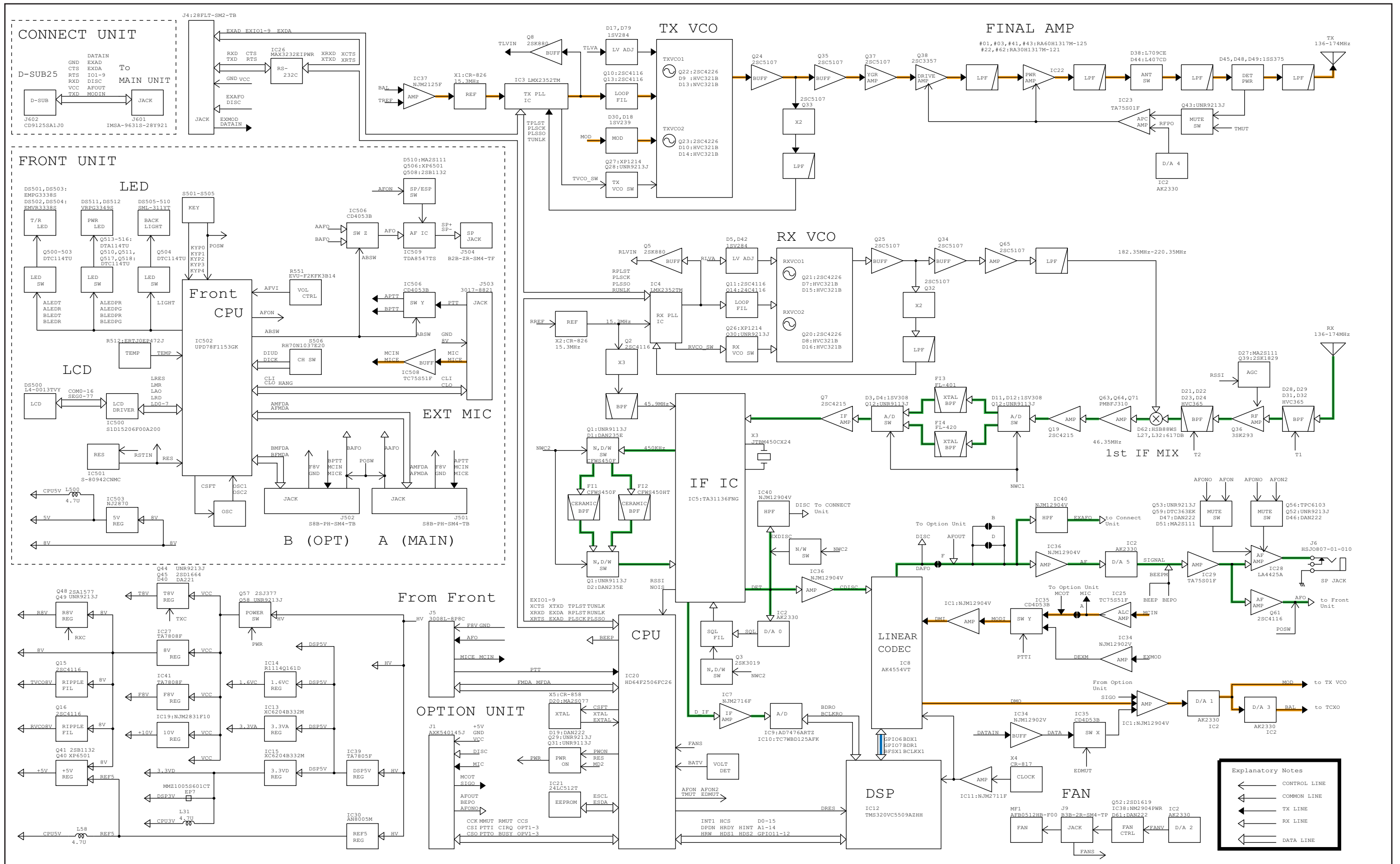

MAIN UNIT (3/3)

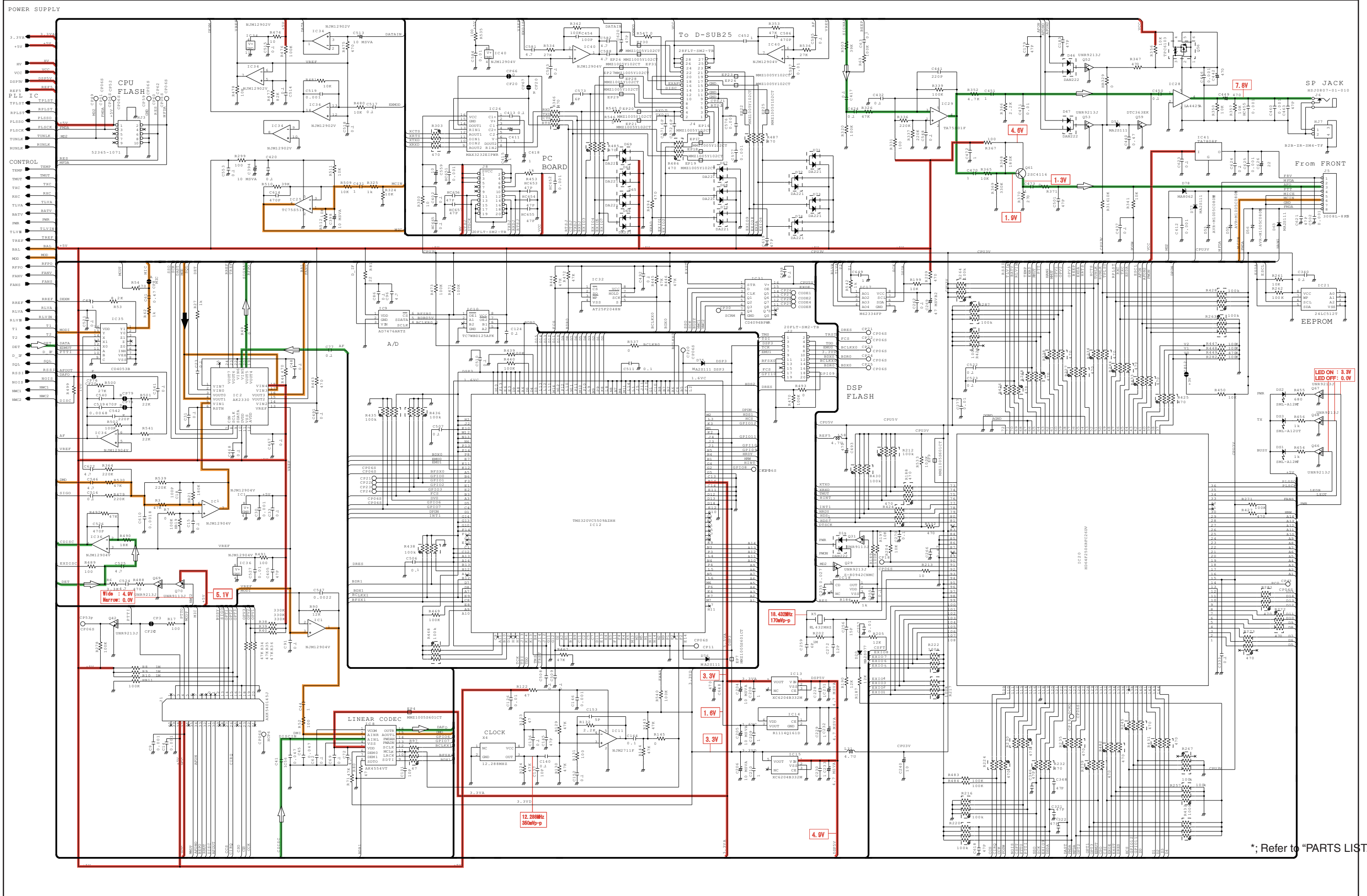

*; Refer to "PARTS LIST"

• ACCESSORY CONNECTOR (CONNECT UNIT) INFORMATION

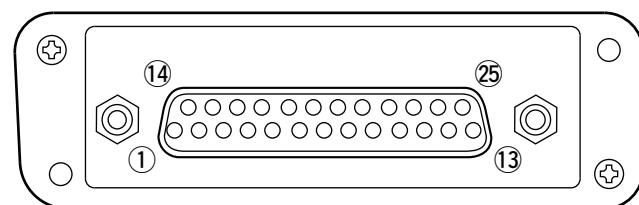
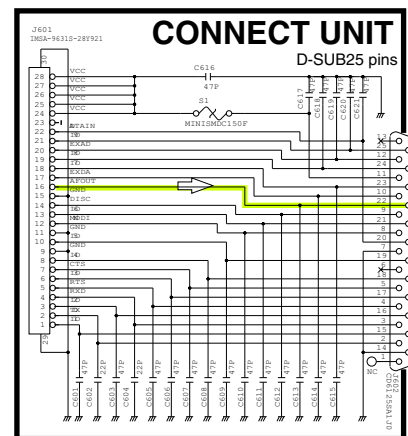

Pin No.	Pin Name	Description	Specification
1	NC	No connection	—
2	TXD	Output terminal for serial communication data.	—
3	RXD	Input terminal for serial communication data.	—
4	RTS	Output terminal for request-to-send data.	—
5	CTS	Input terminal for clear-to-send data.	—
6	NC	No connection	—
7	GND	Serial/digital signal ground	—
8	MOD IN	Modulator input from an external terminal unit.	Input level: 300 mV rms
9	DISC OUT	Output terminal for AF signals from the AF detector circuit. Output level is fixed, regardless of [AF] control.	Output level: 300 mV rms
10	EXT. D/A	The desired function can be assigned.* (Default: Null)	—
11	VCC	13.6 V (FR6000)/13.2 V (FR6100) DC output	Output current: Less than 1 A
12	EXT. A/D	Customize A/D input (Not used)	—
13	NC	No connection	—
14	GND	Ground	—
15	EXT./O 15	The desired function can be assigned.* (Default: Null)	+5 V pull up, Active=L
16	EXT./O 16	The desired function can be assigned.* (Default: P0 Monitor Output)	+5 V pull up, Active=L
17	EXT./O 17	The desired function can be assigned.* (Default: Busy Output)	+5 V pull up, Active=L
18	EXT./O 18	The desired function can be assigned.* (Default: Null)	+5 V pull up, Active=L
19	EXT./O 19	The desired function can be assigned.* (Default: EPTT Input)	+5 V pull up, Active=L
20	DATA IN	Input terminal for data.	—
21	EXT./O 21	The desired function can be assigned.* (Default: Analog Audible Output)	+5 V pull up, Active=L
22	AF OUT	The AF detector Output.	—
23	EXT./O 23	The desired function can be assigned.* (Default: Mic Mute Output)	+5 V pull up, Active=L
24	EXT./O 24	The desired function can be assigned.* (Default: Null)	+5 V pull up, Active=L
25	EXT./O 25	The desired function can be assigned.* (Default: Mic Hanger Output)	+5 V pull up, Active=L

* The desired function can be assigned using the optional CS-FR5000 CLONING SOFTWARE. Ask your dealer for details.

Icom Inc.

1-1-32, Kamiminami, Hirano-ku, Osaka 547-0003, Japan
Phone : +81 (06) 6793 5302
Fax : +81 (06) 6793 0013
URL : <http://www.icom.co.jp/world/index.html>

Icom America Inc.

<Corporate Headquarters>
2380 116th Avenue N.E., Bellevue, WA 98004, U.S.A.
Phone : +1 (425) 454-8155 Fax : +1 (425) 454-1509
URL : <http://www.icomamerica.com>
E-mail : sales@icomamerica.com
<Customer Service>
Phone : +1 (425) 454-7619

Icom Canada

Glenwood Centre #150-6165
Highway 17 Delta, B.C., V4K 5B8, Canada
Phone : +1 (604) 952-4266 Fax : +1 (604) 952-0090
URL : <http://www.icomcanada.com>
E-mail : info@icomcanada.com

Icom (Australia) Pty. Ltd.

Unit 1 / 103 Garden Road, Clayton VIC 3168 Australia
Phone : +61 (03) 9549-7500 Fax : +61 (03) 9549-7505
URL : <http://www.icom.net.au>
E-mail : sales@icom.net.au

Icom New Zealand

146A Harris Road, East Tamaki,
Auckland, New Zealand
Phone : +64 (09) 274 4062 Fax : +64 (09) 274 4708
URL : <http://www.icom.co.nz>
E-mail : inquiries@icom.co.nz

Beijing Icom Ltd.

10C07, Long silver Mansion, No.88, Yong Ding
Road, Haidian District, Beijing, 100039, China
Phone : +86 (010) 5889 5391/5392/5393
Fax : +86 (010) 5889 5395
E-mail : bjicom@bjicom.com
URL : <http://www.bjicom.com>

Icom (Europe) GmbH

Communication Equipment
Auf der Krautweide 24
65812 Bad Soden am Taunus, Germany
Phone : +49 (6196) 76685-0 Fax : +49 (6196) 76685-50
URL : <http://www.icomeurope.com>
E-mail : info@icomeurope.com

Icom Spain S.L

Ctra. Rubi, No. 88 Bajos A 08174, Sant Cugat del Valles, Barcelona, Spain
Phone : +34 (93) 590 26 70 Fax : +34 (93) 589 04 46
URL : <http://www.icomspain.com>
E-mail : icom@icomspain.com

Icom (UK) Ltd.

Blacksole House, The Boulevard, Altira Business Park, Herne Bay, CT6 6GZ, UK
Phone : +44 (01227) 741741 Fax : +44 (01227) 741742
URL : <http://www.icomuk.co.uk>
E-mail : info@icomuk.co.uk

Icom France s.a.s.

Zac de la Plaine
1 Rue Brindejone des Moulinais BP 5804
31505 Toulouse Cedex, France
Phone : +33 (5) 61 36 03 03 Fax : +33 (5) 61 36 03 00
URL : <http://www.icom-france.com>
E-mail : icom@icom-france.com

Asia Icom Inc.

6F No.68, Sec. 1 Cheng-Teh Road, Taipei, Taiwan, R.O.C.
Phone : +886 (02) 2559 1899 Fax : +886 (02) 2559 1874
URL : <http://www.asia-icom.com>
E-mail : sales@asia-icom.com

Icom Polska

81-850 Sopot, ul. 3 Maja 54, Poland
Phone : +48 (58) 550 7135 Fax : +48 (58) 551 0484
E-mail : icompolska@icompolska.com.pl

Count on us!

Icom Inc.

1-1-32, Kamiminami, Hirano-ku, Osaka 547-0003, Japan

S-14515XZ-C1
© 2008 Icom Inc.